

Hitachi AMS 2000 Family Command Control Interface (CCI) Reference Guide

FASTFIND LINKS

[Changes in this revision](#)

[Applicable platforms](#)

[Getting help](#)

[Table of contents](#)

© 2008-2014 Hitachi, Ltd. All rights reserved.

No part of this publication may be reproduced or transmitted in any form or by any means, electronic or mechanical, including photocopying and recording, or stored in a database or retrieval system for any purpose without the express written permission of Hitachi, Ltd. and Hitachi Data Systems Corporation (hereinafter referred to as "Hitachi").

Hitachi, Ltd. and Hitachi Data Systems reserve the right to make changes to this document at any time without notice and assume no responsibility for its use. Hitachi, Ltd. and Hitachi Data Systems products and services can only be ordered under the terms and conditions of Hitachi Data Systems' applicable agreements.

All of the features described in this document may not be currently available. Refer to the most recent product announcement or contact your local Hitachi Data Systems sales office for information on feature and product availability.

Notice: Hitachi Data Systems products and services can be ordered only under the terms and conditions of Hitachi Data Systems' applicable agreements. The use of Hitachi Data Systems products is governed by the terms of your agreements with Hitachi Data Systems.

Hitachi is a registered trademark of Hitachi, Ltd. in the United States and other countries. Hitachi Data Systems is a registered trademark and service mark of Hitachi in the United States and other countries.

All other trademarks, service marks, and company names in this document are properties of their respective owners.



Table of contents

Preface	vii
Intended audience	viii
Product version	viii
Release notes and readme	viii
Document revision level	viii
Changes in this revision	ix
Document organization	ix
Applicable platforms	x
Document conventions	xiii
Convention for storage capacity values	xiv
Related documents	xiv
Getting help	xix
Comments	xix
1 Performing CCI Operations	1-1
Important notice	1-2
Environment variables	1-3
Instance number and option for command execution environment	1-4
Creating pairs (paircreate)	1-7
Splitting pairs (pairsplit)	1-14
Timing of pairsplit operations	1-19
Resynchronizing pairs (pairresync)	1-20
Confirming pair operations (pairevtwait)	1-25
Monitoring pair activity (pairmon)	1-29
Checking attribute and status (pairvolchk)	1-31
Displaying pair status (pairdisplay)	1-34
Checking pair currency (paircurchk)	1-40
Performing takeover operations (horctakeover)	1-43
Horctakeover command functions	1-46
Takeover-switch function	1-46
Swap-takeover function	1-48

SVOL-takeover function	1-48
PVOL-takeover function (TrueCopy only)	1-49
Applications of the horctakeover command	1-49
Displaying configuration information	1-51
Raidscan command	1-51
Raidar command	1-57
Raidqry command	1-58
Data protection	1-60
Raidvchkset command	1-60
Volume restrictions	1-62
Raidvchkdsp command	1-62
Raidvchkscan command	1-66
Controlling CCI activity	1-68
Horcmstart command	1-68
Horcmshutdown command	1-70
Horcctl command	1-70
Windows 2000 and Windows Server subcommands	1-73
Findcmddev subcommand	1-73
Drivescan subcommand	1-74
Portscan subcommand	1-75
Sync and syncd subcommand	1-76
Mount subcommand	1-78
Umount subcommand	1-81
Environment variable subcommands	1-83
Command tools	1-85
Inqraid command tool	1-85
Mkconf command tool	1-93
Host group control	1-96
Specifying a host group	1-96
Commands and options including a host group	1-96
Volume migration	1-98
Overview	1-98
Specifications	1-98
Commands to control the Volume Migration	1-99
Relations between "cc" command issues and status	1-100
Synchronous waiting command (pairsyncwait)	1-101

2 Troubleshooting 2-1

ShadowImage troubleshooting	2-2
SnapShot troubleshooting	2-4
TrueCopy troubleshooting	2-6
TCE troubleshooting	2-11
General troubleshooting	2-16
Error reporting	2-19
Data recovery for PSUE using ShadowImage	2-31

Recovering the pair	2-31
Internal LUN, device recognized by the host	2-32
Pair-splitting guidelines	2-32
Data recovery for PSUE using SnapShot	2-33
Recovering the pair	2-33
Data recovery for PSUE using TrueCopy and TCE	2-34
Recovering the pair	2-34
3 Maintenance log and tracing functions	3-1
Log files	3-2
Trace files	3-4
Trace control command	3-4
How to read detailed error log codes	3-5
Solaris	3-6
Linux	3-7
Windows	3-8
Sense code and detail code	3-9
Logging of a command	3-66
4 Command options	4-1
Command options for copy types	4-2

Glossary

Index



Preface

The Command Control Interface (CCI) Reference Guide describes and provides instructions for performing Command Control Interface (CCI) software operations on the Adaptable Modular Storage (AMS) array. The CCI software enables you to issue Copy-on-write SnapShot (hereafter called SnapShot), ShadowImage in-system replication (hereafter called ShadowImage), Synchronous Remote Copy (hereinafter called TrueCopy), and Asynchronous Remote Copy (hereinafter called TCE) commands to the AMS array from the open-systems host (UNIX-based or PC server host).

This preface includes the following information:

- [Product version](#)
- [Release notes and readme](#)
- [Document revision level](#)
- [Changes in this revision](#)
- [Intended audience](#)
- [Document organization](#)
- [Applicable platforms](#)
- [Document conventions](#)
- [Convention for storage capacity values](#)
- [Related documents](#)
- [Getting help](#)
- [Comments](#)

Intended audience

This document is intended for system administrators, Hitachi Data Systems representatives, and Authorized Service Providers who are involved in installing, configuring, or operating the AMS.

This document assumes that you, as the user:

- Have a background in data processing and understand RAID storage arrays and their basic functions.
- Are familiar with the AMS array.
- Are familiar with the functionality of the ShadowImage and SnapShot features.
- Are familiar with the functionality of the TrueCopy and TCE features.
- Have read and understand the *ShadowImage in-system Replication User's Guide*.
- Have read and understand the *Copy-on-write SnapShot User's Guide*.
- Have read and understand the *Modular Volume Migration User's Guide*.
- Have read and understand the *TrueCopy Remote Replication User's Guide*.
- Have read and understand the *TrueCopy Extended Distance User's Guide*.

Product version

This document revision applies to CCI software version 01-32-03/01 or later, and AMS 2000 Family firmware version 08C3/R or later.

Release notes and readme

Read the release notes and readme file before installing and using this product. They may contain requirements or restrictions that are not fully described in this document and updates or corrections to this document.

Document revision level

Revision	Date	Description
MK-97DF8121-01	October 2008	Initial Release
MK-97DF8121-02	December 2008	Revision 1, supersedes and replaces revision 01.
MK-97DF8121-03	March 2009	Revision 2, supersedes and replaces revision 02.
MK-97DF8121-04	June 2009	Revision 3, supersedes and replaces revision 03.
MK-97DF8121-05	August 2009	Revision 4, supersedes and replaces revision 04.

Revision	Date	Description
MK-97DF8121-06	November 2009	Revision 5, supersedes and replaces revision 05.
MK-97DF8121-07	January 2010	Revision 6, supersedes and replaces revision 06.
MK-97DF8121-08	April 2010	Revision 7, supersedes and replaces revision 07.
MK-97DF8121-09	August 2010	Revision 8, supersedes and replaces revision 08.
MK-97DF8121-10	November 2010	Revision 9, supersedes and replaces revision 09.
MK-97DF8121-11	December 2010	Revision 10, supersedes and replaces revision 10.
MK-97DF8121-12	February 2011	Revision 11, supersedes and replaces revision 11.
MK-97DF8121-13	May 2011	Revision 12, supersedes and replaces revision 12.
MK-97DF8121-14	March 2012	Revision 14, supersedes and replaces revision 13.
MK-97DF8121-15	December 2012	Revision 15 supersedes and replaces revision 14.
MK-97DF8121-16	January 2013	Revision 16 supersedes and replaces revision 15.
MK-97DF8121-17	September 2013	Revision 17 supersedes and replaces revision 16.
MK-97DF8121-18	April 2014	Revision 18 supersedes and replaces revision 17.
MK-97DF8121-19	August 2014	Revision 19 supersedes and replaces revision 18.

Changes in this revision

- Under [Displaying pair status \(pairdisplay\) \(page 1-34\)](#), changed the Returned Values definition.
- Revised [Figure 1-31 \(page 1-39\)](#) and [Figure 1-32 \(page 1-39\)](#), and added R/W: ?Shows "-" below them.
- Under [Sync and syncd subcommands \(page 1-76\)](#), revised first sentence.
- In [Table 4-1 \(page 4-2\)](#), added -f [r] to the pairdislay and raidscan commands. Also, added the new commands inqraid, mkconf, rmawk, and all the commands following rmawk.

Document organization

The following table provides an overview of the contents and organization of this document. Click the [chapter title](#) in the left column to go to that chapter. The first page of each chapter provides links to the sections in that chapter.

Chapter	Description
Chapter 1, Performing CCI Operations	Provides details of CCI functionality.
Chapter 2, Troubleshooting	Provides troubleshooting guidelines and customer support contact information.
Chapter 3, Maintenance log and tracing functions	Discusses logs and tracing functions.
Chapter 4, Command options	Describes command options execution.

Applicable platforms

This document applies to the following platforms:

Vendor	Operating System
Oracle	Solaris 8 (SPARC)
	Solaris 9 (SPARC)
	Solaris 10 (SPARC)
	Solaris 10 (x86)
	Solaris 10 (x64)
Microsoft	Windows 2000
	Windows Server 2003 (IA32)
	Windows Server 2008 (IA32)
	Windows Server 2003 (x64)
	Windows Server 2008 (x64)
	Windows Server 2003 (IA64)
	Windows Server 2008 (IA64)
	Windows Server 2012 (x64)
Red Hat	Red Hat Linux AS 2.1 (IA32)
	Red Hat Linux AS/ES 3.0 (IA32)
	Red Hat Linux AS/ES 4.0 (IA32)
	Red Hat Linux AS/ES 5.0 (IA32)
	Red Hat Linux AS/ES 3.0 (AMD64/EM64T)
	Red Hat Linux AS/ES 4.0 (AMD64/EM64T)
	Red Hat Linux AS/ES 5.0 (AMD64/EM64T) Note 2
	Red Hat Linux AS/ES 6.0 (AMD64/EM64T) Note 2
	Red Hat Linux AS/ES 3.0 (IA64)
	Red Hat Linux AS/ES 4.0 (IA64) Note 1

Vendor	Operating System
HP	HP-UX 11i V1.0 (PA-RISC)
	HP-UX 11i V2.0 (PA-RISC)
	HP-UX 11i V3.0 (PA-RISC)
	HP-UX 11i V2.0 (IPF)
	HP-UX 11i V3.0 (IPF)
	Tru64 UNIX 5.1
IBM	AIX 5.1
	AIX 5.2
	AIX 5.3
	AIX 6.1
SGI	IRIX 6.5.x



NOTE 1: The 32-bit library is required to execute the CCI command in the AMD64/EM64T environment. The 32-bit library is not installed in the AMD64/EM64T by default and must be installed.



NOTE 2: To execute the CCI command when Red Hat Linux AS4.0 is used in the IPF environment (IA64), it is required to install all the 32-bit compatible packages for IA-32EL (Execution Layer). When you install the IA-32EL, install all the 32-bit compatible packages (except CCI for Linux/IA64).

Virtual OS applies to the following platforms:

Vendor	Host Operating System	Guest Operating System
VMware	VMware ESX Server 3.0	Windows 2000
		Windows Server 2003
		Red Hat Linux AS3.0
		Red Hat Linux AS4.0
	VMware ESX Server 4.0	Windows Server 2003
		Windows Server 2008
	VMware ESXi Server 5.0	Windows Server 2003
		Windows Server 2008
		Red Hat Linux AS5.0
Microsoft	Windows Server 2008 Hyper-V	Windows Server 2003 SP2
		Windows Server 2008
	Windows Server 2008 R2 Hyper-V2.0	Windows Server 2003 SP2
		Windows Server 2008 R2
Hitachi	Virtage (58-12)	Windows Server 2008 R2
		Red Hat Enterprise Linux 5.4

The following table shows the IPv6-supported platforms.

Vendor	Operating System	IPv4 Mapped IPv6
Microsoft	Windows Server 2003 + IPv6 install (IA32)	N/A
	Windows Server 2008 (IA32)	N/A
	Windows Server 2003 + IPv6 install (x64)	N/A
	Windows Server 2008 (x64)	N/A
	Windows Server 2003 + IPv6 install (IA64)	N/A
	Windows Server 2008 (IA64)	N/A
	Windows Server 2012 (x64)	N/A
Oracle	Solaris 8 (SPARC)	
	Solaris 9 (SPARC)	
	Solaris 10 (SPARC)	
	Solaris 10 (x86)	
	Solaris 10 (x64)	
IBM	AIX 5.1	
	AIX 5.2	
	AIX 5.3	
	AIX 6.1	
Red Hat	Red Hat Linux AS/ES 2.1 (IA32)	
	Red Hat Linux AS/ES 3.0 (IA32)	
	Red Hat Linux AS/ES 4.0 (IA32)	
	Red Hat Linux AS/ES 5.0 (IA32)	
	Red Hat Linux AS/ES 3.0 (AMD64/EM64T)	
	Red Hat Linux AS/ES 4.0 (AMD64/EM64T)	
	Red Hat Linux AS/ES 5.0 (AMD64/EM64T)	
	Red Hat Linux AS/ES 6.0 (AMD64/EM64T)	
	Red Hat Linux AS/ES 3.0 (IA64)	
	Red Hat Linux AS/ES 4.0 (IA64)	
HP	HP-UX 11i V2.0 (PA-RISC)	
	HP-UX 11i V3.0 (PA-RISC)	
	HP-UX 11i V2.0 (IPF)	
	HP-UX 11i V3.0 (IPF)	





For more information about IPv6, see the *Hitachi AMS 2000 Family Command Control Interface (CCI) User's Guide*.

Document conventions

This document uses the following typographic conventions:

Convention	Description
Bold	Indicates text on a window, other than the window title, including menus, menu options, buttons, fields, and labels. Example: Click OK .
<i>Italic</i>	Indicates a variable, which is a placeholder for actual text provided by you or the system. Example: <i>copy source-file target-file</i> Angled brackets (< >) are also used to indicate variables.
screen or code	Indicates text that is displayed on screen or entered by you. Example: # <code>pairdisplay -g oradb</code>
< > angled brackets	Indicates a variable, which is a placeholder for actual text provided by you or the system. Example: # <code>pairdisplay -g <group></code> Italic font is also used to indicate variables.
[] square brackets	Indicates optional values. Example: [a b] indicates that you can choose a, b, or nothing.
{ } braces	Indicates required or expected values. Example: { a b } indicates that you must choose either a or b.
vertical bar	Indicates that you have a choice between two or more options or arguments. Examples: [a b] indicates that you can choose a, b, or nothing. { a b } indicates that you must choose either a or b.
<u>underline</u>	Indicates the default value. Example: [<u>a</u> b]

This document uses the following icons to draw attention to information:

Icon	Label	Description
	Note	Calls attention to important or additional information.
	Tip	Provides helpful information, guidelines, or suggestions for performing tasks more effectively.
	Caution	Warns you of adverse conditions or consequences (for example, disruptive operations).
	WARNING	Warns you of severe conditions or consequences (for example, destructive operations).
	DANGER!	Dangers provide information about how to avoid physical injury to yourself and others.



NOTE: In this document, the term "Windows Server" refers collectively to Windows Server 2003, Windows Server 2008 and Windows Server 2012.

Convention for storage capacity values

Physical storage capacity values (for example, disk drive capacity) are calculated based on the following values:

Physical capacity unit	Value
1 KB	1,000 bytes
1 MB	1,000 KB or 1,000 ² bytes
1 GB	1,000 MB or 1,000 ³ bytes
1 TB	1,000 GB or 1,000 ⁴ bytes
1 PB	1,000 TB or 1,000 ⁵ bytes
1 EB	1,000 PB or 1,000 ⁶ bytes

Logical storage capacity values (for example, logical device capacity) are calculated based on the following values:

Logical capacity unit	Value
1 block	512 bytes
1 KB	1,024 (2 ¹⁰) bytes
1 MB	1,024 KB or 1024 ² bytes
1 GB	1,024 MB or 1024 ³ bytes
1 TB	1,024 GB or 1024 ⁴ bytes
1 PB	1,024 TB or 1024 ⁵ bytes
1 EB	1,024 PB or 1024 ⁶ bytes

Related documents

The AMS 2000 Family user documentation is available on the Hitachi Data Systems Portal: <https://portal.hds.com>. Please check this site for the most current documentation, including important updates that may have been made after the release of the product.

This documentation set consists of the following documents.

Release notes

- Adaptable Modular Storage System Release Notes
- Storage Navigator Modular 2 Release Notes



Please read the release notes before installing or using this product. They may contain requirements and restrictions not fully described in this document, along with updates and corrections to this document.

Installation and getting started

The following documents provide instructions for installing an AMS 2000 Family storage system. They include rack information, safety information, site-preparation instructions, getting-started guides for experienced users, and host connectivity information. The symbol  identifies documents that contain initial configuration information about Hitachi AMS 2000 Family storage systems.

 **AMS2100/2300 Getting Started Guide**, MK-98DF8152

Provides quick-start instructions for getting an AMS 2100 or AMS 2300 storage system up and running as quickly as possible.

 **AMS2500 Getting Started Guide**, MK-97DF8032

Provides quick-start instructions for getting an AMS 2500 storage system up and running as quickly as possible.

AMS 2000 Family Site Preparation Guide, MK-98DF8149

Contains initial site planning and pre-installation information for AMS 2000 Family storage systems, expansion units, and high-density expansion units. This document also covers safety precautions, rack information, and product specifications.

AMS 2000 Family Fibre Channel Host Installation Guide,
MK-08DF8189

Describes how to prepare Hitachi AMS 2000 Family Fibre Channel storage systems for use with host servers running supported operating systems.

AMS 2000 Family iSCSI Host Installation Guide, MK-08DF8188

Describes how to prepare Hitachi AMS 2000 Family iSCSI storage systems for use with host servers running supported operating systems.

Storage and replication features

The following documents describe how to use Storage Navigator Modular 2 (Navigator 2) to perform storage and replication activities.

Storage Navigator 2 Advanced Settings User's Guide, MK-97DF8039

Contains advanced information about launching and using Navigator 2 in various operating systems, IP addresses and port numbers, server certificates and private keys, boot and restore options, outputting configuration information to a file, and collecting diagnostic information.

Storage Navigator Modular 2 User's Guide, MK-99DF8208

Describes how to use Navigator 2 to configure and manage storage on an AMS 2000 Family storage system.

AMS 2000 Family Dynamic Provisioning Configuration Guide, MK-09DF8201

Describes how to use virtual storage capabilities to simplify storage additions and administration.

Storage Navigator 2 Storage Features Reference Guide for AMS, MK-97DF8148

Contains concepts, preparation, and specifications for Account Authentication, Audit Logging, Cache Partition Manager, Cache Residency Manager, Data Retention Utility, LUN Manager, Performance Monitor, SNMP Agent, and Modular Volume Migration.

AMS 2000 Family Copy-on-write SnapShot User Guide, MK-97DF8124

Describes how to create point-in-time copies of data volumes in AMS 2100, AMS 2300, and AMS 2500 storage systems, without impacting host service and performance levels. Snapshot copies are fully read/write compatible with other hosts and can be used for rapid data restores, application testing and development, data mining and warehousing, and nondisruptive backup and maintenance procedures.

AMS 2000 Family ShadowImage In-system Replication User Guide, MK-97DF8129

Describes how to perform high-speed nondisruptive local mirroring to create a copy of mission-critical data in AMS 2100, AMS 2300, and AMS 2500 storage systems. ShadowImage keeps data RAID-protected and fully recoverable, without affecting service or performance levels. Replicated data volumes can be split from host applications and used for system backups, application testing, and data mining applications while business continues to operate at full capacity.

AMS 2000 Family TrueCopy Remote Replication User Guide, MK-97DF8052

Describes how to create and maintain multiple duplicate copies of user data across multiple AMS 2000 Family storage systems to enhance your disaster recovery strategy.

AMS 2000 Family TrueCopy Extended Distance User Guide,
MK-97DF8054

Describes how to perform bi-directional remote data protection that copies data over any distance without interrupting applications, and provides failover and recovery capabilities.

AMS 2000 Data Retention Utility User's Guide, MK-97DF8019

Describes how to lock disk volumes as read-only for a certain period of time to ensure authorized-only access and facilitate immutable, tamper-proof record retention for storage-compliant environments. After data is written, it can be retrieved and read only by authorized applications or users, and cannot be changed or deleted during the specified retention period.

Storage Navigator Modular 2 online help

Provides topic and context-sensitive help information accessed through the Navigator 2 software.

Hardware maintenance and operation

The following documents describe how to operate, maintain, and administer an AMS 2000 Family storage system. They also provide a wide range of technical information and specifications for the AMS 2000 Family storage systems. The symbol  identifies documents that contain initial configuration information about Hitachi AMS 2000 Family storage systems.

 **AMS 2100/2300 Storage System Hardware Guide,** MK-97DF8010

Provides detailed information about installing, configuring, and maintaining AMS 2100 and 2300 storage systems.

 **AMS 2500 Storage System Hardware Guide,** MK-97DF8007

Provides detailed information about installing, configuring, and maintaining an AMS 2500 storage system.

 **AMS 2000 Family Storage System Reference Guide,** MK-97DF8008

Contains specifications and technical information about power cables, system parameters, interfaces, logical blocks, RAID levels and configurations, and regulatory information about AMS 2100, AMS 2300, and AMS 2500 storage systems. This document also contains remote adapter specifications and regulatory information.

AMS 2000 Family Storage System Service and Upgrade Guide,
MK-97DF8009

Provides information about servicing and upgrading AMS 2100, AMS 2300, and AMS 2500 storage systems.

AMS 2000 Family Power Savings User Guide, MK-97DF8045

Describes how to spin down volumes in selected RAID groups when they are not being accessed by business applications to decrease energy consumption and significantly reduce the cost of storing and delivering information.

Command and Control (CCI)

The following documents describe how to install the Hitachi AMS 2000 Family Command Control Interface (CCI) and use it to perform TrueCopy and ShadowImage operations.

AMS 2000 Family Command Control Interface (CCI) Installation Guide, MK-97DF8122

Describes how to install CCI software on open-system hosts.

AMS 2000 Family Command Control Interface (CCI) Reference Guide, MK-97DF8121 — this document

Contains reference, troubleshooting, and maintenance information related to CCI operations on AMS 2100, AMS 2300, and AMS 2500 storage systems.

AMS 2000 Family Command Control Interface (CCI) User's Guide, MK-97DF8123

Describes how to use CCI to perform TrueCopy and ShadowImage operations on AMS 2100, AMS 2300, and AMS 2500 storage systems.

Command Line Interface (CLI)

The following documents describe how to use Hitachi Storage Navigator Modular 2 to perform management and replication activities from a command line.

Storage Navigator Modular 2 Command Line Interface (CLI) Unified Reference Guide, MK-97DF8089

Describes how to interact with all Navigator 2 bundled and optional software modules by typing commands at a command line.

Storage Navigator 2 Command Line Interface Replication Reference Guide for AMS, MK-97DF8153

Describes how to interact with Navigator 2 to perform replication activities by typing commands at a command line.

Dynamic Replicator documentation

The following documents describe how to install, configure, and use Hitachi Dynamic Replicator to provide AMS Family storage systems with continuous data protection, remote replication, and application failover in a single, easy-to-deploy and manage platform.

Hitachi Dynamic Replicator - Scout Release Notes (RN-99DF8211)

Hitachi Dynamic Replicator - Scout Host Upgrade Guide
(MK-99DF8267)

Hitachi Dynamic Replicator - Scout Host User Guide
(MK-99DF8266)

Hitachi Dynamic Replicator - Scout Installation and Configuration Guide (MK-98DF8213)

Hitachi Dynamic Replicator - Scout Quick Install/Upgrade Guide
(MK-98DF8222)

Getting help

If you need to contact the Hitachi Data Systems support center, please provide as much information about the problem as possible, including:

- The circumstances surrounding the error or failure.
- The exact content of any messages displayed on the host systems.
- The exact content of any messages displayed on Storage Navigator Modular 2.
- The Storage Navigator Modular 2 configuration information. This information is used by service personnel for troubleshooting purposes.

The Hitachi Data Systems customer support staff is available 24 hours a day, seven days a week. If you need technical support, please log on to the Hitachi Data Systems Portal for contact information: <https://portal.hds.com>

Comments

Please send us your comments on this document: doc.comments@hds.com. Include the document title, number, and revision, and refer to specific sections and paragraphs whenever possible.

Thank you! (All comments become the property of Hitachi Data Systems.)

Performing CCI Operations

This chapter includes the following:

- ❑ Important notice
- ❑ Environment variables
- ❑ Creating pairs (paircreate)
- ❑ Splitting pairs (pairsplit)
- ❑ Resynchronizing pairs (pairresync)
- ❑ Confirming pair operations (pairevtwait)
- ❑ Monitoring pair activity (pairmon)
- ❑ Checking attribute and status (pairvolchk)
- ❑ Displaying pair status (pairdisplay)
- ❑ Checking pair currency (paircurchk)
- ❑ Performing takeover operations (horctakeover)
- ❑ Displaying configuration information
- ❑ Data protection
- ❑ Controlling CCI activity
- ❑ Windows 2000 and Windows Server subcommands
- ❑ Command tools
- ❑ Host group control
- ❑ Volume migration
- ❑ Synchronous waiting command (pairsyncwait)

Important notice

Note the following when performing CCI operations:

- Do not execute ShadowImage, SnapShot, TrueCopy, or TCE operations while formatting the volume. Formatting takes priority and ShadowImage, SnapShot, TrueCopy, and TCE operations will be suspended.
- Remember to change the default value for the poll(10ms) parameter in the configuration definition file.
- When an internal process-conflict occurs between the CCI and the array, the processing of the AMS array is temporarily suspended. If the conflict continues, internal processing may not proceed. Therefore, when monitoring (polling) the status of the AMS array (by creating a script using the CCI commands) set the display-information-based commands (that is pairdisplay, raidscan, raidar, and raidqry) to be issued more than or equal to a minute.
- Commands that change the status of pairs (paircreate, pairsplit, pairresync) cannot be executed while changing the firmware online.
- Do not change the firmware online while executing commands that change the status of pairs (paircreate, pairsplit, pairresync). The execution time for the copying process varies; changing the firmware online suspends the copying operation temporarily.

The processing time for changing the firmware online is 4 min.for each CTL (the copying process will be suspended for 4 minutes per CTL). The waiting process in the batch file may end abnormally when executing a copy (using a batch file) by designating a specific time.

- Commands that change the status of pairs (paircreate, pairsplit, pairresync) of TrueCopy and TCE cannot be executed while the host is re-starting in the TrueCopy and TCE environment. The command may end abnormally when executing a command while the host is re-starting.
- It is essential that both P-VOL and V-VOL should be defined in advance from the Storage Navigator Modular 2. Also, the secondary volume (S-VOL) used and assigned by the CCI is the same as the Snapshot image created by Storage Navigator Modular 2.
- In the case of Windows, do not use the diskpart command for a mounting and unmounting of a volume. Refer to [Mount subcommand, on page 1-78](#) and [Unmount subcommand, on page 1-81](#) for use of CCI mount and unmount commands.
- When using host I/O and CCI simultaneously, the completion of CCI commands may be late by the performance and load of the host.
- All command options displayed in help do not perform.
- The options that can perform are limited to the options described in this manual. See [Chapter 4, Command options](#) for details.
- The host machines must run on the operating system (OS) of the same architecture and the same CCI version because the host machine may not be able to recognize the paired volume of another host. However, it is possible to prepare only one server at a secondary site by supporting

CCI communications (32-bit, 64-bit [Tru64]) among different OSs (HP-UX, Solaris, AIX, Linux, and Windows).

Environment variables

When activating HORCM or initiating a command, you can specify any of the environment variables shown in [Table 1-1](#).

Table 1-1: Environment Variables

Variable	Functions
HORCM (/etc/ horcmgr) environment variables	<p>\$HORCM_CONF: Names the HORCM configuration file, default = /etc/horcm.conf.</p> <p>\$HORCM_LOG: Names the HORCM log directory, default = /HORCM/log/curlog.</p> <p>\$HORCM_TRCSZ: Specifies the size of the HORCM trace file in kB, default = 1 MB. The trace file size cannot be changed using the horcctl command.</p> <p>\$HORCM_TRCLVL: Specifies the HORCM trace level (0 - 15), default = 4. If a negative value is specified, trace mode is canceled. The trace level can be changed using the horcctl -c -l command.</p> <p>\$HORCM_TRCBUF: Specifies the HORCM trace mode. If this variable is specified, data is written in the trace file in the non-buffer mode. If not, data is written in the buffer mode. The trace mode can be changed using the horcctl -c -b command.</p> <p>\$HORCM_TRCUENV: Specifies whether or not to succeed the trace control parameters (TRCLVL and TRCBUF) as they are when a command is issued. When this variable is specified, the HORCM default trace control parameters are used to the trace control parameters of HORCM as global parameters. If not, the default trace control parameters for HORCM commands are used and tracing level = 4, trace mode = buffer mode.</p> <p>\$HORCMFCTBL: Changes the fibre address conversion table number, used when the target ID indicated by the raidscan command is different than the TID on the system.</p> <p>\$HORCMPROMOD: Sets HORCM forcibly to protection mode. Command devices in non-protection mode can be used as protection mode also.</p> <p>\$HORCMPerm: Specifies the file name for the protected volumes. When this variable is not specified, the default name is as follows (* as an instance number): For UNIX systems: /etc/horcmperm.conf or /etc/horcmperm*.conf For Windows® 2000 systems: \WINNT\horcmperm.conf or \WINNT\horcmperm*.conf For Windows Server systems: \WINDOWS\horcmperm.conf or \WINNT\horcmperm*.conf When the variable is set HORCMPerm = MGFNOINST, the built-in command will not execute. Set this variable when you want to execute any command from you shell script.</p>

Table 1-1: Environment Variables (Continued)

Variable	Functions
CCI command environment variables	<p>\$HORCC_LOG: Specifies the command log directory name, default = /HORCM/log* (* = instance number). When a magic character STDERROUT is set for this variable, the log output changes to standard error output. Use this character when you want to execute commands from the script file knowing that the error would occur, in order to inhibit log output.</p> <p>\$HORCC_TRCSZ: Specifies the size of the command trace file in kB, default = HORCM trace file size. The default HORCM trace file size can be changed using horcctl -d -s.</p> <p>\$HORCC_TRCLVL: Specifies the command trace level (0 = 15), default = 4 or the specified HORCM trace level. If a negative value is specified, trace mode is canceled. The default trace level for HORCM commands can be changed using the horcctl -d -l.</p> <p>\$HORCC_TRCBUF: Specifies the command trace mode. If specified, data is written in the trace file in the non-buffer mode. If not, the HORCM trace mode is used. The default trace mode for HORCM commands can be changed using the horcctl -d -b.</p>
CCI instance environment variable	<p>\$HORCMINST: Specifies the instance number when using two or more CCI instances on the same host. The command execution environment and the HORCM activation environment require an instance number to be specified. Set the configuration definition file (HORCM_CONF) and log directories (HORCM_LOG and HORCC_LOG) for each instance.</p>
ShadowImage/SnapShot/Data Retention command environment variables	<p>\$HORCC_MRCF: Sets the command execution environment of the ShadowImage, SnapShot, and Data Retention commands. The selection whether the command functions as that of the TrueCopy/TCE or the ShadowImage/SnapShot/Data Retention is made according to this variable. The HORCM is not affected by this variable. When issuing a TrueCopy or TCE command, do not set the HORCC_MRCF variable for the execution environment of the command. When issuing a ShadowImage, SnapShot, or Data Retention command, set the environmental variable HORCC_MRCF=1 for the execution environment of the command.</p> <p>Besides, when returning the command execution environment of ShadowImage, SnapShot, or Data Retention to that of TrueCopy or TCE, set HORCC_MRCF=.</p>

Instance number and option for command execution environment

Normally, the CCI command executes it using a number set for the environmental variable of \$HORCMINST as an instance number. The command operates in the TrueCopy or TCE execution environment when the environmental variable of \$HORCC_MRCF is not set or in the ShadowImage or SnapShot or Data Retention execution environment when the valuable is set as 1. When the option for specifying the instance number is used, the instance number can be specified irrespective of the environmental variable of \$HORCMINST only in the command execution in which the option is used. Besides, when the option for specifying the execution environment is used, the execution environment can be changed irrespective of the environmental variable of \$HORCC_MRCF only in the command execution in which the option is used.

- A way to specify options

- `-I[instance#]`

This option specifies the instance number.

Example:

Execute the `pairdisplay` command setting the instance number as 5.

```
# pairdisplay -g<group> -I5 ...
```

Execute the `pairdisplay` command setting the instance number as no instance number.

```
# pairdisplay -g<group> -I ...
```

- `-IH[instance#]` or `-ITC[instance#]`

This option selects the TrueCopy or TCE execution environment and specifies the instance number.

Example:

Execute the `pairdisplay` command in the TrueCopy or TCE execution environment setting the instance number as no instance number.

```
# pairdisplay -g<group> -IH ...
```

Execute the `pairdisplay` command in the TrueCopy or TCE execution environment setting the instance number as 5:

```
# pairdisplay -g<group> -IH5 ...
```

- `-IM[instance#]` or `-ISI[instance#]`

This option selects the ShadowImage, SnapShot, Data Retention execution environment and specifies the instance number:

Example:

Execute the `pairdisplay` command in the ShadowImage, SnapShot, Data Retention execution environment setting the instance number as no instance number:

```
# pairdisplay -g<group> -IM ...
```

Execute the `pairdisplay` command in the ShadowImage, SnapShot, Data Retention execution environment setting the instance number as 5.

```
# pairdisplay -g<group> -IM5 ...
```



NOTE: In the interactive mode (specified with the `-z` or `-zx` option), a change of the instance number is rejected because the instance number has been fixed.

- Relationship between environment variables and options

When neither the instance number nor the option for specifying the command execution environment is used, the instance number and the command execution environment depend on the setting of the `$HORCMINST` and the `$HORCC_MRCF`. The relation between the instance number and the command execution environment is as shown below. In [Table 1-2](#), X = instance number

Table 1-2: The Instance for the Connection

-I[instance#] Option	\$HORCMINST	Instance
-I	Don't care	No instance number
-IX		Instance number=X
Not specified	HORCMINST=X	Instance number=X
	Not specified	No instance number

Table 1-3: Command Environment Variables

-IH, -IM or -ITC, - ISI Option	\$HORCMINST	Command Environment
-IH or -ITC	Don't care	TrueCopy and TCE
-IM or -ISI		ShadowImage, SnapShot, and Data Retention
Not specified	HORCC_MRCF=1	ShadowImage, SnapShot, and Data Retention
	Not specified	TrueCopy and TCE

- A way to verify instance number and command environment
The instance number and the command execution environment at the time of the command execution are displayed as shown below.

Example:

```

C:\HORCM\etc>pairdisplay -h
Model : RAID-Manager/WindowsNT
Ver&Rev: 01-21-03/06
Usage : pairdisplay [options] for HORC[5]
-h Help/Usage
-I[#] Set to HORCMINST#
-IH[#] or -ITC[#] Set to HORC mode [and HORCMINST#]
-IM[#] or -ISI[#] Set to MRCF mode [and HORCMINST#]
:
  
```

Example with interactive mode:

```
C:\HORCM\etc>pairdisplay -z
pairdisplay[HOMRCF[5]]: -IM
pairdisplay[HOMRCF[5]]: -q
:
```

Instance number
Command environment
(ShadowImage/SnapShot/Data Retention)

Creating pairs (paircreate)



NOTE: Use the paircreate command with caution. The paircreate command starts the ShadowImage, TrueCopy, TCE initial copy operation, which overwrites all data on the secondary volume. If the primary and secondary volumes are not identified correctly, or if the wrong options are specified (**vl** [-**pvol**] instead of **-vr** [-**svol**]), data will be transferred in the wrong direction

The **paircreate** command creates a new volume pair from two unpaired volumes. The paircreate command can create either a paired logical volume or a group of paired volumes.

The paircreate command allows you to specify the direction (local or remote) of the pair creation (see [Figure 1-1](#)). If local (**vl** [-**pvol**] option) is specified, the host issuing the paircreate command has the primary volume. If remote (**vr** [-**svol**] option) is specified, the remote host has the primary volume (ShadowImage, TrueCopy, TCE).

The **-split** option of the paircreate command (ShadowImage, SnapShot) allows you to simultaneously create and split pairs using a single CCI command. When **-split** is used, the pair status changes from COPY to PSUS (instead of PAIR) when the initial copy operation is complete. [Table 1-4](#) lists and describes the paircreate command parameters and returned values.

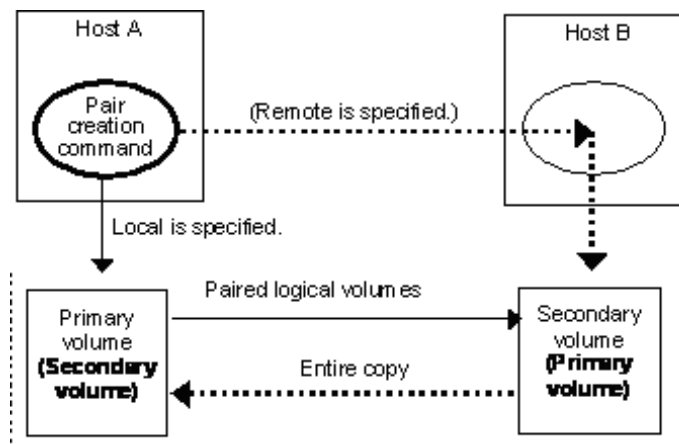

Figure 1-1: Pair Creation

Before issuing the paircreate command, verify that the secondary volume is not mounted on any system. If the secondary volume is mounted after paircreate, delete the pair (pairsplit -S), unmount the secondary volume, and then reissue the paircreate command.



NOTE: The paircreate command terminates before the initial copy operation is complete (except when the **nocopy** option is specified). Use the pair event waiting or pair display command to verify that the initial copy operation completed successfully (status changes from COPY to PAIR, or from COPY to PSUS if the **-split** option was specified). The execution log file also shows completion of the initial copy operation.

The operation of creating a pair is shown below.

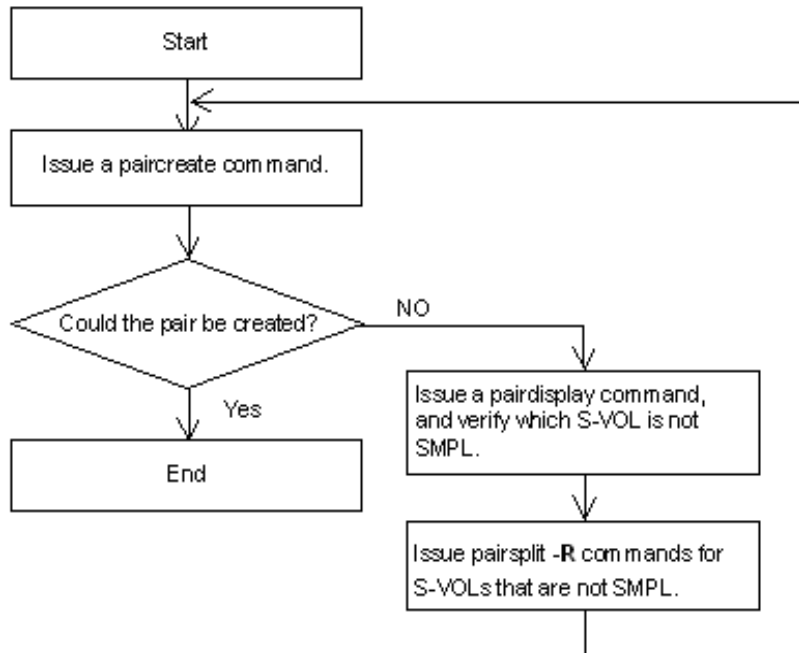

Figure 1-2: Pair Creation Operation

Table 1-4: Paircreate Command Parameters

Parameter	Value
Command Name	paircreate
Format	paircreate { -h -q -z -x -xh -l[H M][instance#] -g group -d pair Vol -d[g] <raw_device> [MU#] -d[g] <seq#> <LDEV#> [MU#]?-f fence [CTGID] -fg <fence> [CTGID] -v -c <size> -nocopy -nomsg -split [[Split-Marker]] [-m <mode>] -jp <PID> -js <PID> -pid <PID> -fq <mode> -p[s]vol }

Table 1-4: Paircreate Command Parameters (Continued)

Parameter	Value
Options	<p>-h: Displays help, usage, and version information.</p> <p>-q: Terminates the interactive mode and exits the command.</p> <p>-z or -zx: Makes the paircreate command enter the interactive mode. The -zx option guards performing of the HORCM in the interactive mode. When this option detects a HORCM shut down, interactive mode terminates.</p> <p>-I[H M][instance#] or -I[TC SI][instance#]: Specifies the instance number and the command execution environment. Refer to Instance number and option for command execution environment on page 1-4.</p> <p>-g <group>: Specifies a group name defined in the configuration definition file. The command is executed for the specified group unless the -d <pair Vol> option is specified.</p> <p>-d <pair Vol>: Specifies paired logical volume name defined in the configuration definition file. When this option is specified, the command is executed for the specified paired logical volume.</p> <p>-d[g] <raw_device> [MU#]: Searches a group on the configuration definition file (local instance) for the specified raw_device, and if the specified raw_device is contained in the group, the target volume is executed as the paired logical volume (-d) or group (-dg). This option is effective without specification of</p> <p>"-g <group> " option. If the specified the raw_device is contained in two or more groups, the command is executed on the first group.</p> <p>-d[g] <seq#> <LDEV#> [MU#]: Searches a group on the configuration definition file (local instance) for the specified LDEV, and if the specified LDEV is contained in the group, the target volume is executed as the paired logical volume (-d) or group (-dg). This option is effective without specification of "-g <group> " option. If the specified LDEV is contained in two or more groups, the command is executed on the first group. The <seq #> <LDEV #> values can be specified in hexadecimal (by addition of "0x ") or decimal notation.</p> <p>-f <fence> [CTGID] or -fg<fence> [CTGID] (TrueCopy and TCE only): Specifies the level for assuring the consistency of paired volume data. For TrueCopy, a fence level of "never" or "data" must be specified. For TCE, a fence level of "async" must be specified. This option is required for TrueCopy and TCE. In case of TrueCopy, use the -f option when the CTG is not used and use the -fg option when the CTG is used. For TCE, use the -f option. Be sure to use the CTG for TCE. In the -f option, when other than "async" is specified to the fence level, CTGID (CT group ID) is disregarded. If the "CTGID" option is not specified, the pair is automatically assigned to a new group. When the CTGID is not specified, the CTG is the group specified in the configuration definition file. Each pair in the same group cannot be assigned to separate CTGs in the configuration definition file. If "CTGID" is not specified and the maximum CTG groups already exist, an EX_ENOCTG error will be returned.</p> <p>Restriction: When pairs to be operated are specified with a group name in case where two or more groups of CCI are included in the same CTGID, all the pairs in the same CTGID are operated at the same time. CCI registers the group in the configuration file, mapping them in the CTGID managed by the array at the time of pair creation. The number of CTGs that can be registered in the array is up to 256 (CTGID: 0 to 255) for TrueCopy or up to 16 (CTGID: 0 to 15) for TCE.</p>

Table 1-4: Paircreate Command Parameters (Continued)

Parameter	Value
Options (continued)	<p>Example: When the CTG is not used in TrueCopy <pre># paircreate -g VG01 -vl -f never</pre> When the CTG is used in TrueCopy (The CTGID is assigned automatically.) <pre># paircreate -g VG01 -vl -fg never</pre> When the CTG is used in TrueCopy (The CTGID is specified expressly.) <pre># paircreate -g VG01 -vl -fg never 1</pre> When the CTGID is assigned automatically in TCE <pre># paircreate -g VG01 -vl -f async</pre> When the CTGID is specified expressly in TCE <pre># paircreate -g VG01 -vl -f async 1</pre> -vl (-pvol) or -vr (-svol): Specifies the data flow direction and must always be specified. The <code>-vl (-pvol)</code> option specifies "local" and the host which issues the command possesses the primary volume. The <code>-vr (-svol)</code> option specifies "remote" and the remote host possesses the primary volume while the local host possesses the secondary volume. -c <size>: You can use this option to specify the copying pace (1 - 15) to be used for the initial data copy. You can shorten the copy time by specifying a large number. (1 to 5: slow, 6 to 10: normal, 11 to 15: prior) -fq <mode>: Specify "normal" or "quick" with "-split". -nocopy (TrueCopy and TCE): Creates paired volumes without copying data in the case in which the data consistency of simplex volumes is assured by you. -nomsg: Suppresses messages to be displayed when this command is executed. It is used to execute this command from a user program. This option must be specified at the beginning of a command argument. The command execution log is not affected by this option. -split [Split-Marker] (ShadowImage and SnapShot only): Splits the paired volume after the initial copy operation is complete. Also, an optional character string (with ASCII 31 characters), which is specified by a user, can be added to the S-VOL (V-VOL) as a <Split-Marker>. -m <mode> (ShadowImage only): For mode, users can specify the following option: noread: Specifies the noread mode for hiding the secondary volume. The secondary volume becomes read-disabled when this mode option is specified. The secondary volume is read-enabled when this mode option is omitted. Note: The primary volume becomes read-disabled only during a reverse resync operation (restore option of pairresync command). mode=grp [CTGID] (SnapShot and ShadowImage only) Makes a group for splitting all SnapShot and ShadowImage pairs specified in a group. SnapShot and ShadowImage guarantee data consistency among multiple LUNs in a group at a single point in time when doing a split using the "pairsplit -g <group>" command (except "-S" or "-E" option). A CTGID is assigned automatically if you do not specify the "CTGID" option in this command. If "CTGID" is not specified and the maximum CTG already exist, an EX_ENOCTG error will be returned. Therefore, the "CTGID" option can forcibly assign a volume group to an existing CTGID. Note: This option cannot be specified with "-split" option in the same command. A plurality of pairs can be created to one P-VOL. But, the number of pairs that can be set in one group is one pair per one P-VOL (see Figure 1-3, "Paircreate Command", on page 1-11 and Figure 1-4, "Paircreate Command -m Option (Correct Example)", on page 1-12). mode=cc (Volume Migration only): This option instructs the copying of the volume migration to be made.</p>

Table 1-4: Paircreate Command Parameters (Continued)

Parameter	Value
Options (continued)	<p>The -vl (-pvol) specifies the local instruction, that is, an instruction to copy a local instance LU (P-VOL) to a remote instance LU (S-VOL) and to maps a copying destination volume (a volume of the remote instance) to the local instance LU (P-VOL).</p> <p>The -vr (-svol) specifies the remote instruction, and copies data from a remote instance LU (P-VOL) to a local instance LU (S-VOL) and maps a copy destination volume (a volume of the local instance) to the remote instance LU (P-VOL).</p> <p>Note: This option cannot be specified with “-split” option in the same command.</p> <p>-jp <PID> -js <PID>: This is necessary when TCE is used. The options can be specified by TCE only. The number (data pool ID) of a data pool used by a P-VOL is specified with the -jp option and that used by an S-VOL is specified with the -js option.</p> <p>Note: The -jp and -js options are enabled when the fence level is specified as “async.” When the -jp and -js options are omitted, 0 is used as a data pool ID.</p> <p>-pid <PID> (SnapShot only): This option specified the data pool number (data pool ID) which the pair to create uses. When one P-VOL configures a pair with two or more V-VOLs, the pair configured by the same P-VOL needs to use a common data pool. If this option is omitted, 0 is used as a data pool ID.</p>
Returned values	<p>Normal termination: 0. When creating groups, 0 = normal termination for all pairs.</p> <p>Abnormal termination: Returns a common error code and a unique error code for this command. For details on error codes, see Chapter 2, Troubleshooting.</p>

 **NOTE:** During TrueCopy and TCE pair operations, there are cases where pair operation fail when high volume host I/O or frequent change of pair status is occurring on both local and remote array. If a pair operation fails and pair status does not change, retry the pair operation (pairvolchk command can be used to check pair status). If a pair operation fails partially when doing pair operation by groups, then the operation must be performed for each pair within that group.

```

C:\HORCM\etc>paircreate -g VG01 -vl -c 15
C:\HORCM\etc>pairevtwait -g VG01 -s pair -t 300 10
pairevtwait : Wait status done.

C:\HORCM\etc>pairdisplay -g VG01
Group   PairVol(L/R) (Port#,TID, LU-M) ,Seq#,LDEV#.P/S,Status, Seq#,P-LDEV# M
VG01   oradb1(L)   (CL1-A , 1, 1-0 )85000174    1.P-VOL PAIR,85000174    2 -
VG01   oradb1(R)   (CL1-A , 1, 2-0 )85000174    2.S-VOL PAIR,-----    1 -

```

Figure 1-3: Paircreate Command

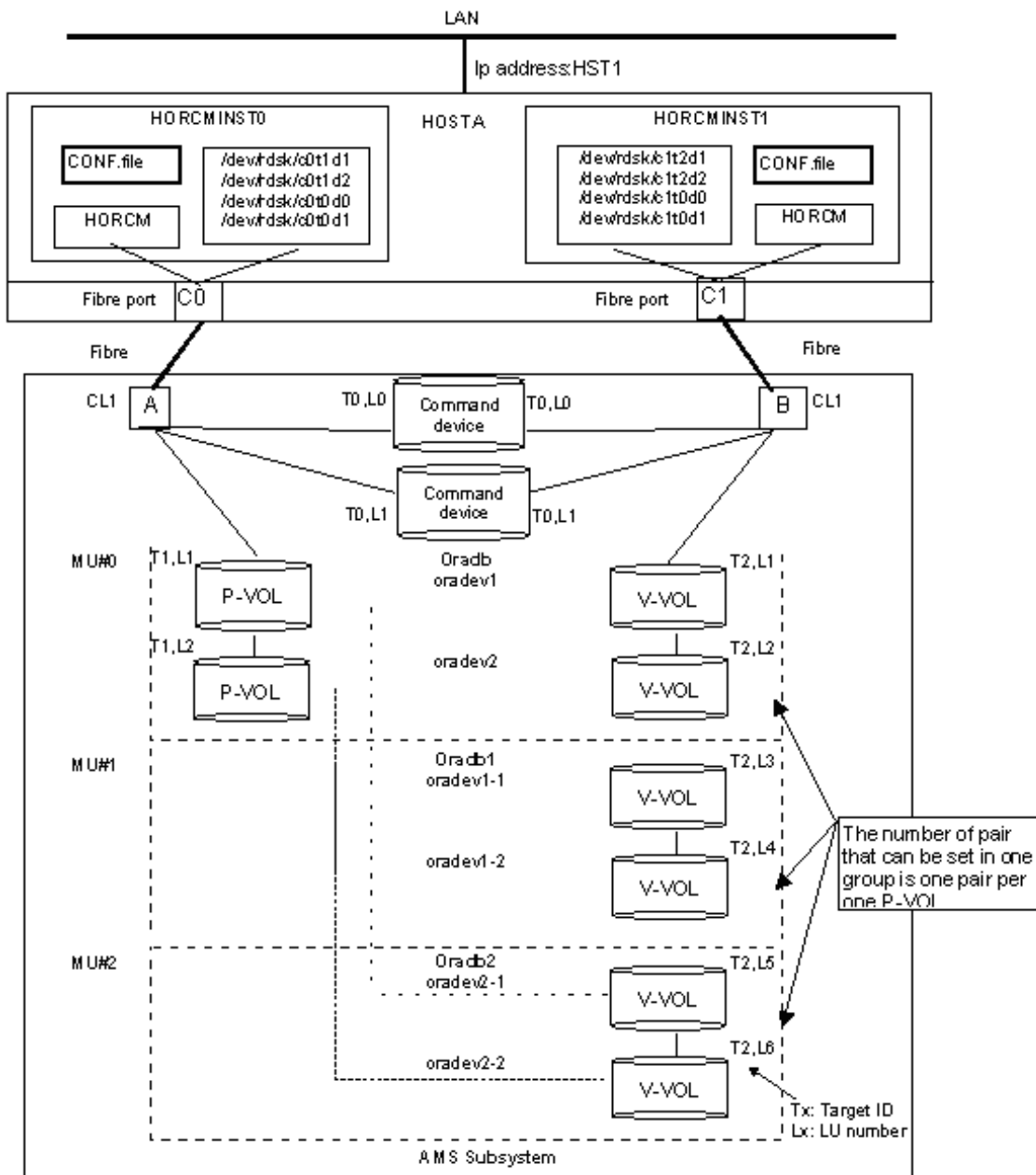

Figure 1-4: Paircreate Command -m Option (Correct Example)

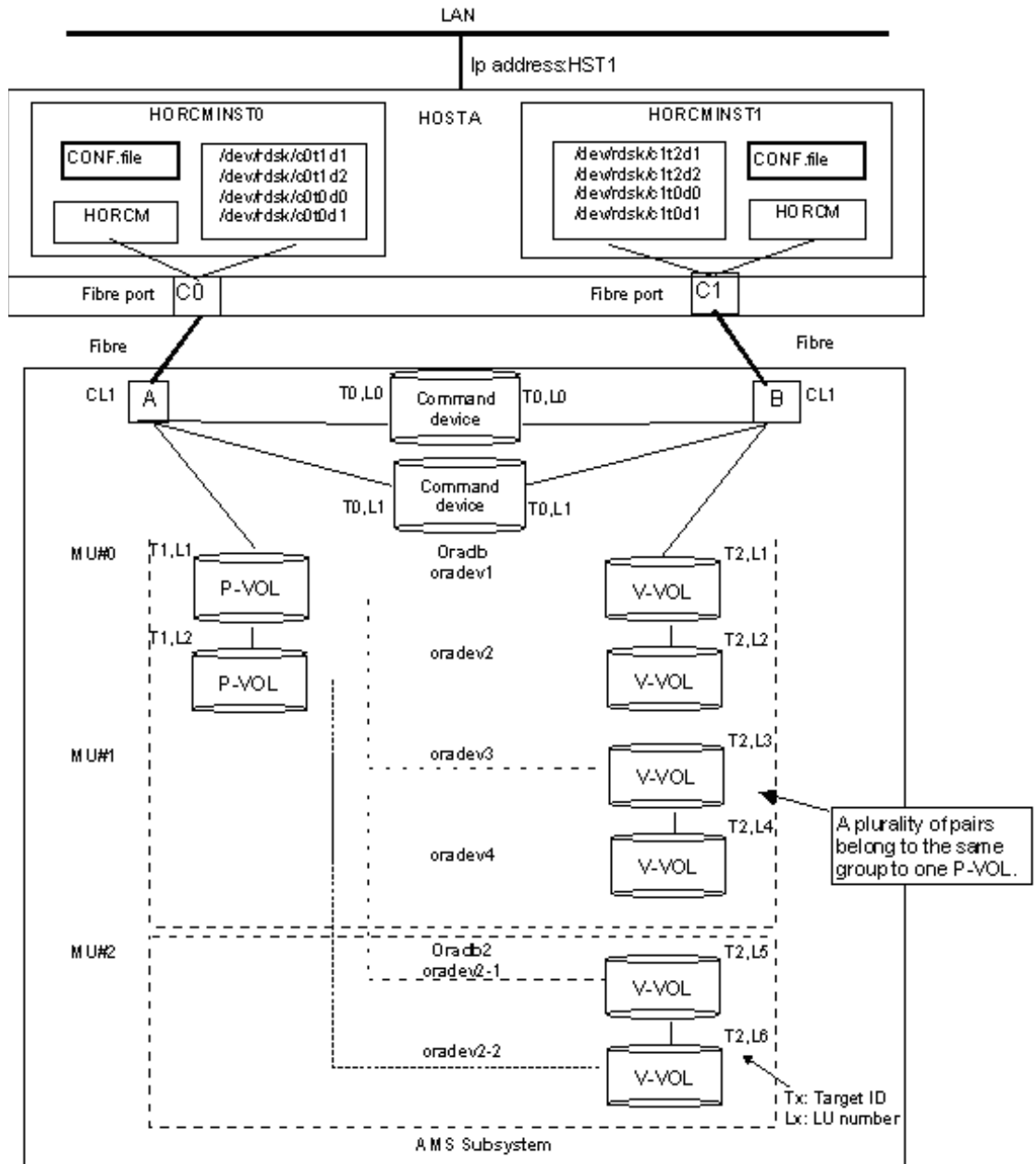

Figure 1-5: Paircreate Command -m Option (Incorrect Example)

Splitting pairs (pairsplit)

The **pairsplit** command stops updates to the secondary volume of a pair (see [Figure 1-6](#)). The pairsplit command allows read/write access to the secondary volume. The pairsplit command can be applied to a paired logical volume or to a group of paired volumes. [Table 1-5](#) lists and describes the pairsplit command parameters and returned values.

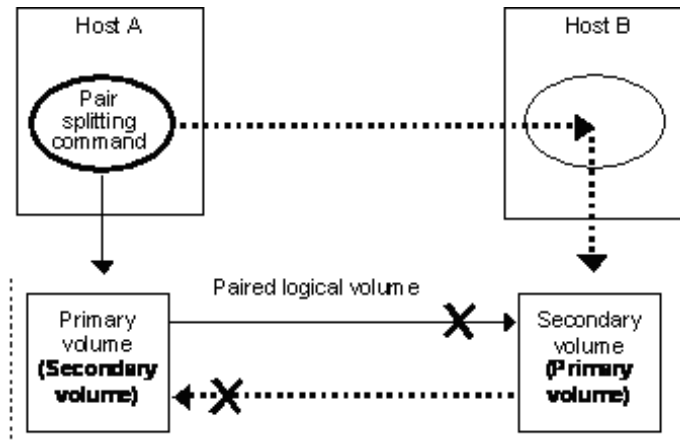

Figure 1-6: Pair Splitting

The pairsplit command allows read/write access to the secondary volume, depending on the selected options (-r, -rw, -S, -R, -E, -ms, -mscas, -RB). The primary volume's host is automatically detected by the pairsplit command, so the host does not need to be specified in the pairsplit command parameters. If the -S option (simplex) is used, the volume pair is deleted, the volumes are returned to the simplex state, and the primary and secondary volume status is lost. Paired volumes are split as soon as the pairsplit command is issued. If you want to synchronize the volumes, the pairsplit command must be issued after write I/Os to the paired volume have been completed.

When splitting a pair, regardless of whether you can change the pair status of S-VOL, changing the pair status of P-VOL to SMPL takes priority. Therefore, if the pair status of S-VOL cannot be changed to SMPL, the pair status of P-VOL might not correspond with that of S-VOL.

When a path failure has occurred or when S-VOL is not used temporarily (for example, while formatting), the pair status of S-VOL cannot be changed to SMPL.

When you want to change the status of P-VOL and S-VOL to SMPL, a pairdisplay command is issued and a pairsplit -R command is issued for S-VOL that is not SMPL. (This can be specified for TrueCopy and TCE).

When the pairsplit -R is issued for S-VOL in paired state, a pairsplit -S is issued for P-VOL to change the status of P-VOL to SMPL.

When the S-VOL of the TCE pair is placed in the SMPL status through an issue of a command for the pair splitting (pairsplit -R) to the TCE pair, the S-VOL data may become unsettled data that is being copied. Therefore, to use the data as the settled one on which the P-VOL data has been reflected,

change the volume status to SSWS by issuing the command for the takeover (horctakeover) beforehand, and then issue the command for the pair splitting (pairsplit -R).



NOTE: During the period until the response of the command is returned after the pair status change command such as pairsplit is executed, the pairdisplay command cannot be executed in the same screen. Therefore, start another screen and execute pairdisplay to check the pair status.

Table 1-5: Pairsplit Command Parameters

Parameter	Value
Command Name	pairsplit
Format	pairsplit {-h -q -z -I[H M][instance#] -g <group> -d <pair Vol> -d[g] <raw_device> [MU#] -FHORC -FMRCF [MU#] -d[g] <seq#> <LDEV#> [MU#] -r -rw -S -R[B] -I -nomsg -C <size> -fq <mode> -E -ms<Split-Marker> -mscas<Split-Marker> [MU#]}
Options <i>Note:</i> Only one pairsplit option (-r, -rw, -S, -C, -E) can be specified. If more than one option is specified, only the last option will be executed.	<p>-h: Displays help, usage, and version information.</p> <p>-q: Terminates the interactive mode and exits this command.</p> <p>-z or -zx: Makes the pairsplit command enter the interactive mode. The -zx option guards performing of the HORCM in the interactive mode. When this option detects a HORCM shut down, interactive mode terminates.</p> <p>-I[H M][instance#] or -I[TC SI][instance#]: Specifies the instance number and the command execution environment. Refer to Instance number and option for command execution environment on page 1-4.</p> <p>-g <group>: Specifies a group name defined in the configuration definition file. This option must always be specified. The command is executed for the specified group unless the -d <pair Vol> option is specified.</p> <p>-d <pair Vol>: Specifies the paired logical volume name defined in the configuration definition file. When this option is specified, the command is executed for the specified paired logical volumes.</p> <p>-d[g] <raw_device> [MU#]: Searches a group on the configuration definition file (local instance) for the specified raw_device, and if the specified raw_device is contained in the group, the target volume is executed as the paired logical volume (-d) or group (-dg). This option is effective without specification of " -g <group>" option. If the specified the raw_device is contained in two or more groups, the command is executed on the first group.</p> <p>-FHORC or -FCA: Forcibly specifies a cascading TrueCopy and TCE volume for specified pair logical volumes in a ShadowImage and SnapShot environment (see example in Figure 1-7 on page 1-17). If the -I option is specified, this option splits a cascading TrueCopy or TCE volume on a local host. If no -I option is specified, this option splits a cascading TrueCopy or TCE volume on a remote host. The target TrueCopy or TCE volume must be a P-VOL and the -R option cannot be specified.</p> <p>What can be cascaded with the TCE is the P-VOL of SnapShot only. In the case where the P-VOL of SnapShot is cascaded with the S-VOL of TCE, an instruction to split the SnapShot pair cannot be issued directly when both pairs are in the PAIR status.</p>

Table 1-5: Pairsplit Command Parameters (Continued)

Parameter	Value
Options (continued)	<p>-FMRCF [MU#] or -FBC [MU#]: Forcibly specifies a cascading ShadowImage or SnapShot volume for specified pair logical volumes in a TrueCopy or TCE environment (see example in Figure 1-8 on page 1-18). If the -I option is specified, this option splits a cascading ShadowImage or SnapShot volume on a local host. If no -I option is specified, this option splits a cascading ShadowImage or SnapShot volume on a remote host. The target ShadowImage or SnapShot volume must be a P-VOL and the -E option cannot be specified.</p> <p>-d[g] <seq#> <LDEV#> [MU#]: Searches a group on the configuration definition file (local instance) for the specified LDEV, and if the specified LDEV is in the group, the target volume is executed as the paired logical volume (-d) or group (-dg). This option is effective without specification of “-g <group>” option. If the specified LDEV is contained in two or more groups, the command is executed on the first group. The <seq #> <LDEV #> values can be specified in hexadecimal (by addition of “0x”) or decimal notation.</p> <p>-r or -rw (for TrueCopy and TCE): Specifies a mode of access to the S-VOL after paired volumes are split. The -r option (default) allows read-only from the S-VOL. The -rw option enables read and write access for the S-VOL.</p> <p>-S: Selects simplex mode (releases the pair). When the pairing direction is reversed among the hosts (that is, disaster recovery), this mode is established once, and then the paircreate command is issued. If you want to re-establish a pair which has been released, you must use the paircreate command (not pairresync).</p> <p>-R (for TrueCopy and TCE): Brings the secondary volume into the simplex mode forcibly. It is issued by the secondary host, if the host possessing the primary volume is down or has failed.</p> <p>-RB (for TrueCopy): Backs up the secondary volume forcibly from SSWS into PSUS (PSUE) (SSUS) mode. This makes it able to back up from the primary volume if the user wants to back from the secondary host in SSWS state due to a Link failure of the primary host.</p> <p>-I: When this command cannot utilize the remote host for host down, this option enables a pairsplit operation by local host only. The target volume of local host can be P-VOL or S-VOL.</p> <p>-nomsg: Suppresses messages to be displayed when this command is executed. It is used to execute a command from a user program. This option must be specified at the beginning of a command argument. The command execution log is not affected by this option.</p> <p>-C <size>: This option does not affect an operation even if it specified or omitted.</p> <p>-fq <mode>: Specify “normal” or “quick” with “-split”.</p> <p>-E (ShadowImage only): Suspends a paired volume forcibly when a failure occurs. Not normally used.</p> <p>-ms <Split-Marker> (for ShadowImage and SnapShot only): This option adds the optional character strings (ASCII code of 31 characters) specified by you to the S-VOL or the V-VOL as <Split-Marker>.</p> <p>-mscas <Split-Marker> [MU#] (TCE only): This option splits the V-VOL of the SnapShot pair cascaded with the S-VOL of the TCE pair by issuing an instruction (only the group can be specified) to TCE. As to the TCE pair targeted, its S-VOL must be cascaded with a SnapShot pair with the same “MU#.” All the TCE pairs concerned must be in the PAIR status. All the SnapShot pairs must be in the PSUS or PAIR status. All the TCE pairs concerned must be in a specified group within the CTG and must be in the PAIR status only. Also, an optional character string (with ASCII 31 characters), which is specified by a user, can be added to the V-VOL as a <Split-Marker>. Incidentally, this option cannot be used together with the option of -d.</p>

Table 1-5: Pairsplit Command Parameters (Continued)

Parameter	Value
Returned values	Normal termination: 0. When creating groups, 0 = normal termination for all pairs. Abnormal termination: Returns a common error code and a unique error code for this command. For details on error codes, see Chapter 2, Troubleshooting .



Note 1: During TrueCopy and TCE pair operations, there are cases where pair operations fail because high volume host I/O or frequent changing of pair status occurs on both local and remote arrays. If a pair operation fails and pair status does not change, retry the pair operation (pairvolchk command can be used to check pair status). If a pair operation fails partially when doing pair operation by groups, then the operation must be performed for each pair within that group.

Note 2: When two or more groups, which are specified in the configuration definition file, exist in the CTG, an instruction to split the pairs issued to a group specified in the configuration definition file is executed for the entire CTG.

Note 3: When the TCE pairsplit command is executed, the response time differs depending on the options.

- pairsplit, pairsplit -S: When the status is PAIR, the response is delayed depending on the amount of the differential data
- pairsplit -R, pairsplit -mscas: The response is made immediately after the command is executed.

Note 4: For TCE, using the -d option with the pairsplit -R command allows you to delete a pair from the S-VOL side. In this case the P-VOL does not recognize that the S-VOL is in SMPL status. When the P-VOL tries to send differential data to the S-VOL, it recognizes that the S-VOL is gone, and the pair becomes PSUE. When one pair in the CTG becomes PSUE, the other pairs also become PSUE. However, from the S-VOL side, the PSUE is not seen and pair status remains PAIR.

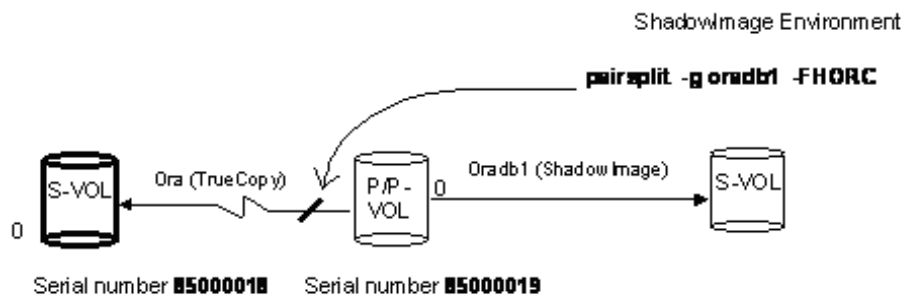

Figure 1-7: Example of -FHORC Option for Pairsplit

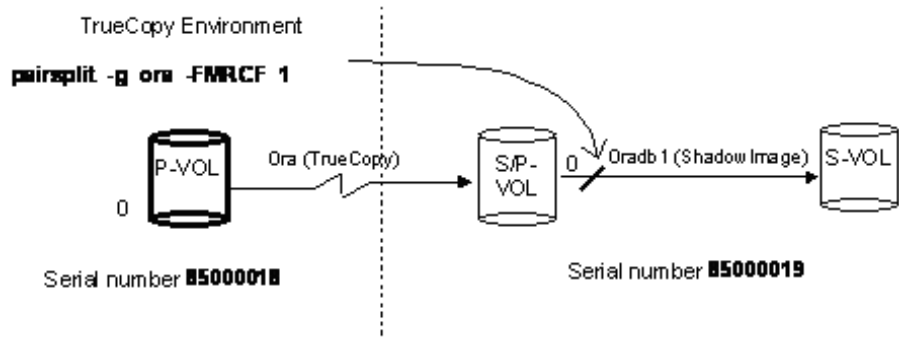

Figure 1-8: Example of -FMRCF Option for Pairsplit

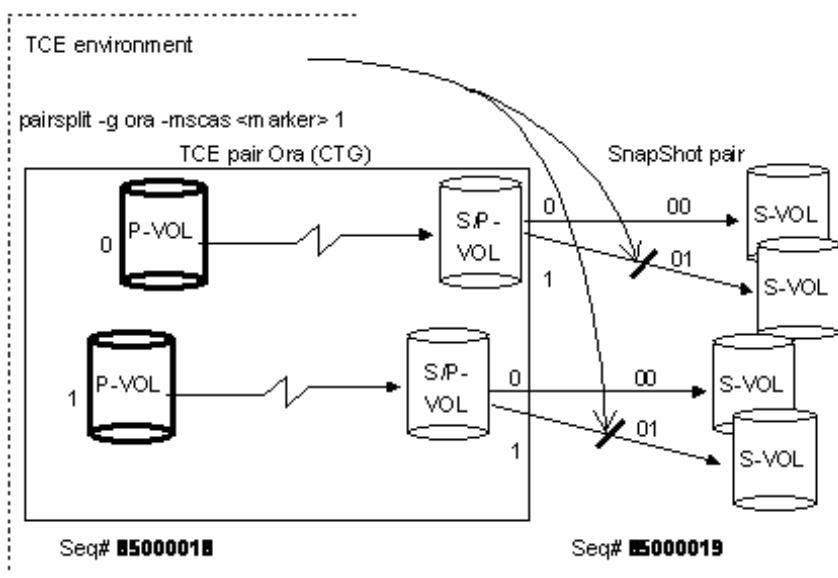

Figure 1-9: Example of -mscas Option for Pairsplit

```
C:\HORCM\etc>pairsplit -g VG01

C:\HORCM\etc>pairdisplay -g VG01
Group   PairVol(L/R) (Port#,TID, LU-M) ,Seq#,LDEV#.P/S,Status, Seq#,P-LDEV# M
VG01    oradb1(L)   (CL1-A , 1, 1-0 )85000174    1.P-VOL PSUS,85000174    2 -
VG01    oradb1(R)   (CL1-A , 1, 2-0 )85000174    2.S-VOL SSUS,-----    1 -
```

Figure 1-10: Pair Split Command

```
C:\HORCM\etc>pairsplit -g VG01 -E

C:\HORCM\etc>pairdisplay -g VG01
Group   PairVol(L/R) (Port#,TID, LU-M) ,Seq#,LDEV#.P/S,Status, Seq#,P-LDEV# M
VG01    oradb1(L)   (CL1-A , 1, 1-0 )85000174    1.P-VOL PSUE,85000174    2 -
VG01    oradb1(R)   (CL1-A , 1, 2-0 )85000174    2.S-VOL PSUE,-----    1 -
```

Figure 1-11: Pair Split Command -E Option

```

C:\HORCM\etc>pairsplit -g VG01 -S

C:\HORCM\etc>pairdisplay -g VG01
Group  PairVol(L/R) (Port#,TID, LU-M) ,Seq#,LDEV#.P/S,Status, Seq#,P-LDEV# M
VG01   oradb1(L)   (CL1-A , 1, 1-0 )85000174 1.SMPL ----,----- 2 -
VG01   oradb1(R)   (CL1-A , 1, 2-0 )85000174 2.SMPL ----,----- 1 -

```

Figure 1-12: Pair Split Command -S Option

Timing of pairsplit operations

Since a pair is split at the time when the pairsplit command is issued, verify that writing onto pair volumes is fixed before issuing the command.

- Instantaneous offline backup of the UNIX file system:
 - Unmount the primary volume, and then split the volume pair.
 - Mount the primary volume (**mount**).
 - Verify that the pairsplit is complete, and mount the secondary volume (**mount -r**).
 - Execute the backup.
 - Restore the volumes to their previous state, and resynchronize the volume pair (ShadowImage and TrueCopy).
- Online backup of the UNIX file system:
 - Issue the **sync** command to a mounted primary volume to flush the file system buffer, and then split the volume pair in Read/Write mode.
 - Verify that the pairsplit is complete, and then use the **fsck** command to check the consistency of the secondary volume file system.
 - Mount (**mount**) the secondary volume.
 - Execute the backup.
 - Restore the volumes to their previous state and resynchronize the volume pair (ShadowImage and TrueCopy).
- Instantaneous offline backup of the Windows 2000 and Windows Server file systems:
 - Execute **-x unmount** of the primary volume, then split the volume pair.
 - Execute **x-mount** of the primary volume.
 - Verify that the pairsplit is complete, then execute **-x mount** of the secondary volume.
 - Execute the backup.
 - Restore the volumes to their previous state, and resynchronize the volume pair (ShadowImage and TrueCopy).

- Online backup of the Windows 2000 and Windows Server file system:
 - Issue the **x-sync** command to a mounted primary volume to flush the file system buffer, then split the volume pair in Read/Write mode.
 - Verify that the pairsplit is complete, and then use **x-mount** of the secondary volume.
 - Execute the backup.
 - Restore the volumes to their previous state and resynchronize the volume pair (ShadowImage and TrueCopy).



Note 1: If the primary volume is divided by LVM or partition, the control information of LVM or partition on the primary volume is also copied to the secondary volume. When executing the backup from the secondary volume, import this control information and execute pairsplit when activating the secondary volume.

Note 2: TCE takes some time for the pair splitting in order to reflect the P-VOL data on the S-VOL.

Note 3: TCE can split V-VOL of the SnapShot pair cascaded with the secondary volume through the instruction issued from the primary host leaving the pair status as PAIR. From the above, backup data can be collected online more smoothly.

Resynchronizing pairs (pairresync)

The **pairresync** command re-establishes a split pair, and then restarts the update copy operations to the secondary volume (see [Figure 1-13](#)). The pairresync command can resynchronize either a paired logical volume or a group of paired volumes. The normal direction of resynchronization is from the primary volume to the secondary volume. If the **-restore** option is specified (ShadowImage only), the pair is resynchronized in the reverse direction (that is, secondary volume to primary volume). [Figure 1-13](#) shows the normal and restore resync operations. The primary volume is read and write accessible during pairresync. The secondary volume becomes write-disabled when the pairresync command is issued.

[Table 1-6](#) lists and describes the pairresync command parameters and returned values. The primary volume's host is automatically detected by the pairresync command, so the host does not need to be specified in the pairresync command parameters.

The pairresync command terminates before resynchronization of the secondary (or primary) volume is complete. Use the pair event waiting or pair display command to verify that the resync operation completed successfully (status changes from COPY to PAIR). The execution log file also shows completion of the resync operation. The status transition of the paired volume is judged by the status of the primary volume.

If no data was written to the secondary volume while the pair was split, the differential data on the primary volume is copied. If data was written to the secondary volume, the differential data on the primary volume and secondary volume is copied to the secondary volume. This process is reversed when the ShadowImage **-restore** option is specified.

Before issuing the pairresync command (normal or reverse direction), make sure that the secondary volume is not mounted on any UNIX system. Before issuing a reverse pairresync command, make sure that the primary volume is not mounted on any UNIX system.



NOTE: Commands that change the status of pairs (paircreate, pairsplit, pairresync) cannot be executed while the host is being restarted in a TrueCopy and TCE environment. Processing may end abruptly when a command is executed while the host is being restarted.

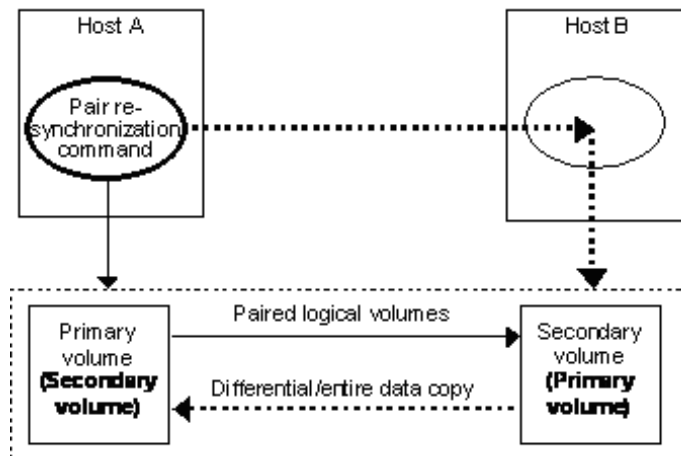
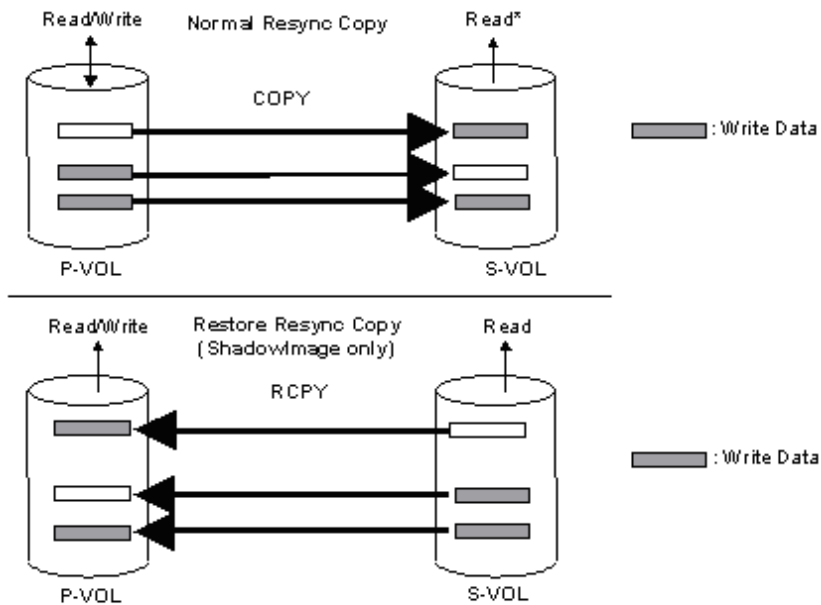

Figure 1-13: Pair Resynchronization



Read*: Read disabled when the paircreate -m noread option is specified.

Figure 1-14: Normal Resync and ShadowImage Restore Resync

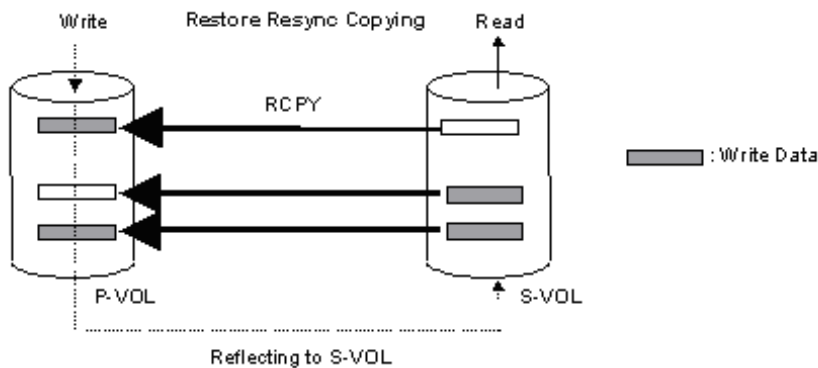

Figure 1-15: Reflecting Write Data to P-VOL during ShadowImage Restore Resync Copy

Table 1-6: Pairresync Command Parameters

Parameter	Value
Command Name	pairresync
Format	pairresync { -h -q -z -I[H M][instance#] -g <group> -d <pair Vol> -d[g] <raw_device> [MU#] -FHORC -FMRCF [MU#] -d[g] <seq#> <LDEV#> [MU#] -c <size> -fq <mode> -nomsg -I -restore -swaps -swapp }
Options	<p>-h: Displays help, usage, and version information.</p> <p>-q: Terminates the interactive mode and exits this command.</p> <p>-z or -zx: Makes the pairresync command enter the interactive mode. The -zx option guards performing of the HORCM in the interactive mode. When this option detects a HORCM shut down, interactive mode terminates.</p> <p>-I[H M][instance#] or -I[TC SI][instance#]: Specifies the instance number and the command execution environment. Refer to Instance number and option for command execution environment on page 1-4.</p> <p>-g <group>: This option is used to specify a group name defined in the configuration definition file. This option must always be specified. The command is executed for the specified group unless the -d <pair Vol> option is specified.</p> <p>-d <pair Vol>: Specifies a paired logical volume name defined in the configuration definition file. When this option is specified, the command is executed for the specified paired logical volumes.</p> <p>-d[g] <raw_device> [MU#]: Searches a group on the configuration definition file (local instance) for the specified raw_device, and if the specified raw_device is contained in the group, the target volume is executed as the paired logical volume (-d) or group (-dg). This option is effective without specification of -g <group> option. If the specified the raw_device is contained in two or more groups, the command is executed on the first group.</p> <p>-FHORC or -FCA: Forcibly specifies a cascading TrueCopy or TCE volume for specified pair logical volumes in a ShadowImage or SnapShot environment (see example in Figure 1-16). If the -I option is specified, this option resyncs a cascading TrueCopy or TCE volume on a local host. If no -I option is specified, this option resyncs a cascading TrueCopy or TCE volume on a remote host. The target TrueCopy or TCE volume must be a P-VOL.</p>

Table 1-6: Pairresync Command Parameters (Continued)

Parameter	Value
Options (continued)	<p>-FMRCF [MU#] or -FBC [MU#]: Forcibly specifies a cascading ShadowImage or SnapShot volume for specified pair logical volumes in a TrueCopy or TCE environment (see example in Figure 1-16, "Example of -FHORC Option for Pairresync", on page 1-24).</p> <p>If the -I option is specified, this option resyncs a cascading ShadowImage or SnapShot volume on a local host. If no -I option is specified, this option resyncs a cascading ShadowImage or SnapShot volume on a remote host. The target ShadowImage or SnapShot volume must be a P-VOL.</p> <p>-d[g] <seq#> <LDEV#> [MU#]: Searches a group on the configuration definition file (local instance) for the specified LDEV, and if the specified LDEV is contained in the group, the target volume is executed as the paired logical volume (-d) or group (-dg). This option is effective without specification of the "-g <group>" option. If the specified LDEV is contained in two or more groups, the command is executed on the first group. The <seq #> <LDEV #> values can be specified in hexadecimal (by addition of "0x") or decimal notation. <seq #> <LDEV #> values can be specified in hexadecimal (by addition of "0x ") or decimal notation.</p> <p>-c <size>: You can use this option to specify the copying pace for the resync operation (range = 1 to 15). If omitted, the value used for paircreate or at previous pairresync will be used. (1 to 5: slow, 6 to 10: normal, 11 to 15: prior)</p> <p>-fq <mode>: Specify "normal" or "quick" with "-split".</p> <p>-nomsg: Suppresses messages to be displayed when this command is executed. It is used to execute this command from a user program. This option must be specified at the beginning of a command argument. The command execution log is not affected by this option.</p> <p>-I: When this command cannot utilize the remote host for host down, this option enables a pairresync operation by the local host only. The target volume of the local host can be P-VOL or S-VOL.</p> <p>-restore: Performs reverse resync (from secondary volume to primary volume).</p> <p>-swaps (TrueCopy only): Executed from the S-VOL side when there is no host on the P-VOL side to help. Typically executed in PSUS state to facilitate "fast fallback" without requiring a full copy. In Figure 1-18, "Pairresync Command", on page 1-24, the left side shows T0 for both the P-VOL and S-VOL (before command execution), and the right side shows T1, after the command has executed. For both -swaps and -swapp, the delta data from the original S-VOL becomes dominant and is copied to the original P-VOL, the S/P-VOL designations are swapped.</p> <p>-swapp (TrueCopy only): Executes the equivalent of a -swaps from the original P-VOL side. Unlike -swaps, -swapp does require the cooperation of hosts at both sides.</p>
Returned Values	<p>Normal termination: 0. When resynchronizing groups, 0 = normal termination for all pairs.</p> <p>Abnormal termination: Returns a common error code and a unique error code for this command. For details on error codes, see Chapter 2, Troubleshooting.</p>



NOTE: During TrueCopy and TCE pair operations, there are cases where pair operations fail when high volume host I/O or frequent change of pair status is occurring on both local and remote array. If pair operation fails and state transition is not done, then retry the pair operation (pairvolchk command can be used to check the state transition). If pair operation fails partially when doing pair operation by groups, then pair operation needs to be done per each pair logical volume within that group.

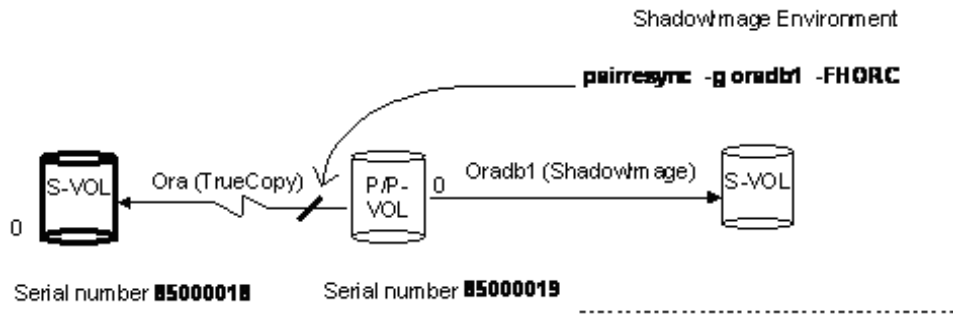

Figure 1-16: Example of -FHORC Option for Pairresync

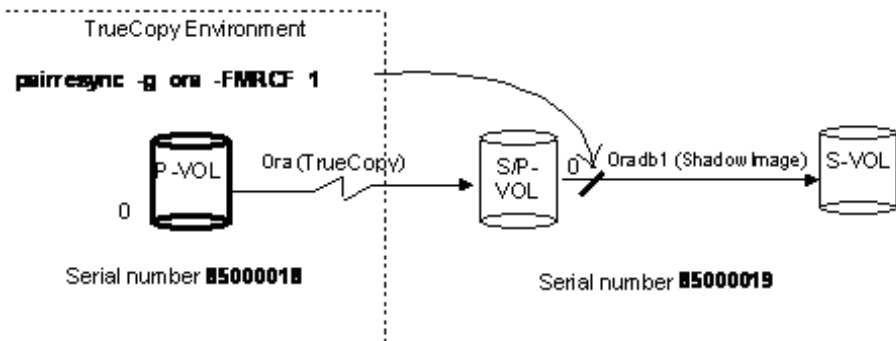

Figure 1-17: Example of -FMRCF Option for Pairresync

```

C:\HORCM\etc>pairresync -g VG01 -c 15

C:\HORCM\etc>pairevtwait -g VG01 -s pair -t 300 10
pairevtwait : Wait status done.

C:\HORCM\etc>pairdisplay -g VG01
Group   PairVol(L/R) (Port#,TID, LU-M) ,Seq#,LDEV#.P/S,Status, Seq#,P-LDEV# M
VG01   oradb1(L)  (CL1-A , 1, 1-0 )85000174 1.P-VOL PAIR,85000174 2 -
VG01   oradb1(R)  (CL1-A , 1, 2-0 )85000174 2.S-VOL PAIR,----- 1

```

Figure 1-18: Pairresync Command

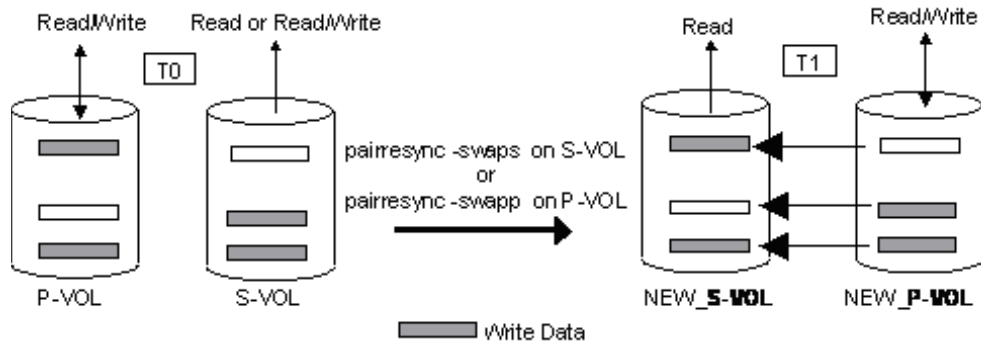

Figure 1-19: Swap Operation

Confirming pair operations (pairevwait)

The pair event waiting (**pairevwait**) command is used to wait for completion of pair creation and pair resynchronization and to check status (see [Figure 1-20](#)). It waits (“sleeps”) until the paired volume status becomes identical to a specified status, then completes. The **pairevwait** command can be used for a paired logical volume or a group of paired volumes. The primary volume’s host is automatically detected by the pair event waiting command, so the host does not need to be specified in the pair event waiting command parameters.

[Table 1-7](#) lists and describes the pair event waiting command parameters and returned values. The pair event waiting command waits until the specified status is established, and terminates abnormally if an abnormal status is detected. The transition of the paired volume status is judged by the status of the primary volume. If the event waiting command is issued for a group, the command waits until the status of each volume in the group becomes identical to the specified status. When the event waiting command with the **-nowait** option is issued for a group, the status is returned if the status of each volume in the group is identical. This command must be used to confirm a pair status transition.

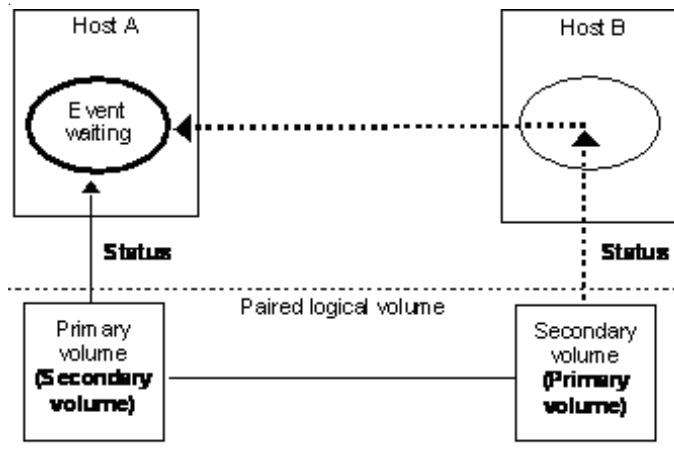

Figure 1-20: Pair Event Waiting

Table 1-7: Pairevwait Command Parameters

Parameter	Value
Command Name	pairevwait
Format	pairevwait { -h -q -z -I[H M][instance#] -g <group> -d <pair Vol> -d[g] <raw_device> [MU#] -FHORC -FMRCF [MU#] -d[g] <seq#> <LDEV#> [MU#] -s[s] <status> ... -t <timeout>[interval] -nowait[s] -I -nomsg }

Table 1-7: Pairevtwait Command Parameters (Continued)

Parameter	Value
Options	<p>-h: Displays help, usage, and version information.</p> <p>-q: Terminates the interactive mode and exits this command.</p> <p>-z or -zx: Makes the pairevtwait command enter the interactive mode. The -zx option guards performing of the HORCM in the interactive mode. When this option detects a HORCM shut down, interactive mode terminates.</p> <p>-I[H M][instance#] or -I[TC SI][instance#]: Specifies the instance number and the command execution environment. Refer to Instance number and option for command execution environment on page 1-4.</p> <p>-g <group>: Specifies a group name defined in the configuration definition file. This option must always be specified. The command is executed for the specified group unless the -d <pair Vol> option is specified.</p> <p>-d <pair Vol>: Specifies a paired logical volume name defined in the configuration definition file. When this option is specified, the command is executed for the specified paired logical volumes.</p> <p>-d[g] <raw_device> [MU#]: Searches a group on the configuration definition file (local instance) for the specified raw_device, and if the specified raw_device is contained in the group, the target volume is executed as the paired logical volume (-d) or group (-dg). This option is effective without specifying the -g <group> option. If the specified the raw_device is contained in two or more groups, the command is executed on the first group.</p> <p>-FHORC or -FCA: Forcibly specifies a cascading TrueCopy or TCE volume for specified pair logical volumes in a ShadowImage or SnapShot environment (see example in Figure 1-21). If the -I option is specified, this option tests status of a cascading TrueCopy or TCE volume on a local host. If no -I option is specified, this option tests status of a cascading TrueCopy or TCE volume on a remote host. The target TrueCopy or TCE volume must be P-VOL or SMPL.</p> <p>-FMRCF [MU#] or -FBC [MU#]: Forcibly specifies a cascading ShadowImage or SnapShot volume for specified pair logical volumes on a TrueCopy or TCE environment (see example in Figure 1-21, "Example of -FHORC Option for Pairevtwait", on page 1-28).</p> <p>If the -I option is specified, this option tests status of a cascading ShadowImage or SnapShot volume on a local host. If no -I option is specified, this option tests status of a cascading ShadowImage or SnapShot volume on a remote host. The target ShadowImage or SnapShot volume must be P-VOL or SMPL.</p> <p>-d[g] <seq#> <LDEV#> [MU#]: Searches a group on the configuration definition file (local instance) for the specified LDEV, and if the specified LDEV is contained in the group, the target volume is executed as the paired logical volume (-d) or group (-dg). This option is effective without specifying the -g <group> option. If the specified LDEV is contained in two or more groups, the command is executed on the first group. The <seq #> <LDEV #> values can be specified in hexadecimal (by addition of "0x") or decimal notation.</p> <p>-s <status> ...: Specifies the waiting status, which is "smpl", "copy/rcpy", "pair", "psus", or "psue". If two or more statuses are specified following -s, waiting is done according to the logical OR of the specified statuses. This option is valid when the -nowait option is not specified.</p>

Table 1-7: Pairevtwait Command Parameters (Continued)

Parameter	Value
Options (continued)	<p>-ss <status> ...: Specifies the waiting status, which is "smpl", "copy/rcpy", "pair", "ssus", or "psue" on S-VOL. If two or more statuses are specified following -ss, waiting is done according to the logical OR of the specified statuses. This option is valid when the -nowaits option is not specified.</p> <p>-t <timeout> [interval]: Specifies the interval of monitoring a status specified using the -s option and the time-out period in units of 1 sec. Unless [interval] is specified, the default value is used. This option is valid when the -nowait option is not specified. When a value, 2,000,000 or more is specified for the <timeout>, a warning message is displayed.</p> <p>-nowait: When this option is specified, the pair status at that time is reported without waiting. The pair status is set as a returned value for this command. When this option is specified, the -t and -s options are not needed.</p> <p>-nowaits: When this option is specified, the pair status on S-VOL at that time is reported without waiting. The pair status is set as a returned value for this command. When this option is specified, the -t and -ss options are not needed.</p> <p>-l: When this command cannot utilize a remote host for host down, this option executes this command by a local host only. The target volume of the local host can be P-VOL or S-VOL.</p> <p>-nomsg: Suppresses messages to be displayed when this command is executed. It is used to execute a command from a user program. This option must be specified at the beginning of a command argument. The command execution log is not affected by this option.</p>
Returned values	<p>When the -nowait option is specified:</p> <p>Normal termination:</p> <ol style="list-style-type: none"> 1: The status is SMPL. 2: The status is COPY or RCPY. 3: The status is PAIR. 4: The status is PSUS. 5: The status is PSUE. <p>When monitoring groups, 1/2/3/4/5 = normal termination for all pairs.</p> <p>Abnormal termination: Returns a common error code and a unique error code for this command. For details on error codes, see Chapter 2, Troubleshooting.</p> <p>When the -nowaits option is specified:</p> <p>Normal termination:</p> <ol style="list-style-type: none"> 1: The status is SMPL. 2: The status is COPY or RCPY. 3: The status is PAIR. 4: The status is SSUS. (SVOL_PSUS will be displayed as SSUS) 5: The status is PSUE. <p>When monitoring groups, 1/2/3/4/5 = normal termination for all pairs.</p> <p>Abnormal termination: Returns a common error code and a unique error code for this command. For details on error codes, see Chapter 2, Troubleshooting.</p> <p>When the -nowait or -nowaits option is not specified:</p> <p>Normal termination: 0. When monitoring groups, 0 = normal termination for all pairs.</p> <p>Abnormal termination: Returns a common error code and a unique error code for this command. For details on error codes, see Chapter 2, Troubleshooting.</p>

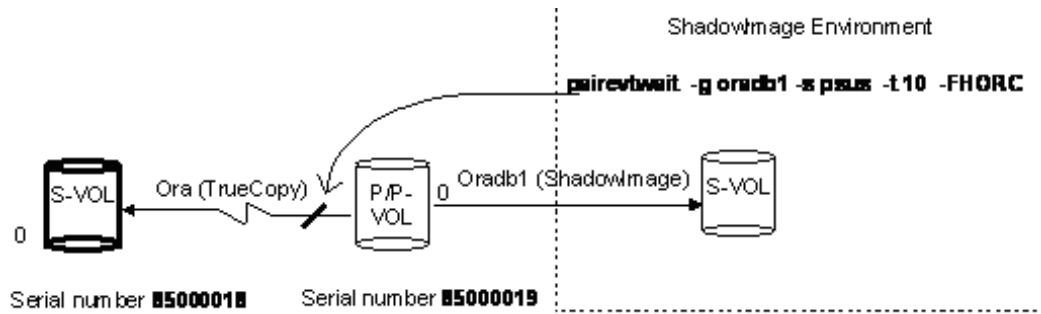

Figure 1-21: Example of -FHORC Option for Pairevtwait

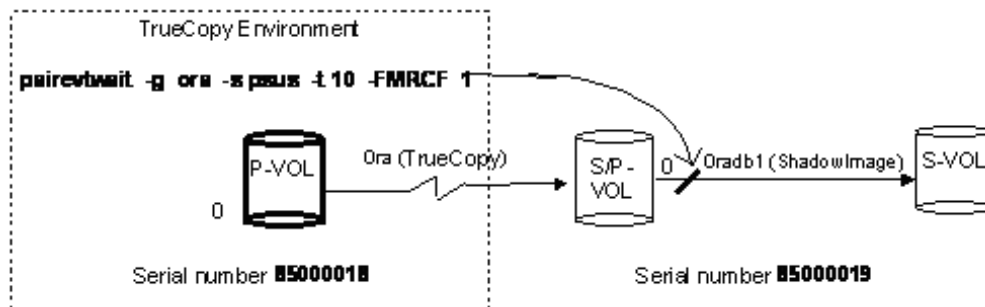

Figure 1-22: Example of -FMRCF Option for Pairevtwait

```
C:\HORCM\etc>paircreate -g VG01 -vl -c 15
C:\HORCM\etc>pairevtwait -g VG01 -s pair -t 300 10
pairevtwait : Wait status done.
```

Figure 1-23: Pairevtwait Command

Monitoring pair activity (pairmon)

The **pairmon** command, connected to the HORCM daemon, obtains the pair status transition of each volume pair and reports it. If the pair status changes (due to an error or a user-specified command), the pairmon command issues a message. [Table 1-8](#) lists and describes the pairmon command parameters.

[Figure 1-24](#) shows an example of the pairmon command and its output. [Table 1-9](#) lists the results of the command options.

The pair status transition events exist in the HORCM pair status transition queue. The **-resevt** option (reset event) deletes one or all events from the HORCM pair status transition queue. If reset event is not specified, the pair status transition queue is maintained. If the **-s** option is not specified, pairmon displays all events for which it receives information from HORCM. If the **-s** option is specified, only the specified status transitions are displayed.

It may take time to reflect the pair status change to the output result of the pairmon command. You can calculate the maximum value of this time in the following formula.

The maximum time to reflect the pair status to the output result: Interval time x number of all pairs defined in the configuration definition file (Value of poll in the configuration definition file)

Calculating the value for poll('0ms):
6000 x the number of all CCI instances that controls the array.

Table 1-8: Pairmon Command Parameters

Parameter	Value
Command Name	pairmon
Format	pairmon { -h -q -z -I[H M][instance#] -D -allsnd -resevt -nowait -s <status> ... }
Options	<p>-h: Displays help, usage, and version information.</p> <p>-q: Terminates the interactive mode and exits this command.</p> <p>-z or -zx: Makes the pairmon command enter the interactive mode. The -zx option guards performing of the HORCM in the interactive mode. When this option detects a HORCM shut down, interactive mode terminates.</p> <p>-I[H M][instance#] or -I[TC SI][instance#]: Specifies the instance number and the command execution environment. Refer to Instance number and option for command execution environment on page 1-4.</p>

Table 1-8: Pairmon Command Parameters (Continued)

Parameter	Value
Options (continued)	<p>-D: Selects the default report mode. In the default mode, if there is pair status transition information to be reported, one event is reported and the event is reset. If there is no pair status transition information to be reported, the command waits. The report mode consists of the three flags: -allsnd, -resevt, and -nowait options.</p> <p>-allsnd: Reports all events if there is pair status transition information.</p> <p>-resevt: Reports events if there is pair status transition information, then resets all events.</p> <p>-nowait: When this option is specified, the command does not wait when there is no pair status transition information.</p> <p>-s <status> ...: Specifies the pair status transition to be reported: smpl, copy (includes rcpy), pair, psus, psue. If two or more statuses are specified following -s, masking is done according to the logical OR of the specified statuses. If this option is not specified, pairmon displays all events which received information from HORCM.</p>



NOTE: In TrueCopy/TCE operation, do not specify the MU# to TrueCopy/TCE pair.

```
# pairmon -allsnd -nowait
Group Pair vol Port targ# lun# LDEV#... Oldstat code -> Newstat code
oradb oradb1 CL1-A 1 5 5... SMPL 0x00 -> COPY 0x01
oradb oradb2 CL1-A 1 6 6... PAIR 0x02 -> PSUS 0x04
```

Figure 1-24: Pairmon Command

The output of the pairmon command includes:

- **Group:** Shows the group name (dev_group) described in the configuration definition file.
- **Pair vol:** Shows the paired volume name (dev_name) in the specified group which is described in the configuration definition file.
- **Port targ# lun#:** Shows the port ID, TID, and LUN described in the configuration definition file.
- **LDEV#:** Shows the array LDEV ID for the specified device. LDEV indicates LU.
- **Oldstat:** Shows the old pair status when the status of the volume is changed.
- **Newstat:** Shows the new pair status when the status of the volume is changed.
- **Code:** Shows the array-internal code for the specified status.

Table 1-9: Results of Pairmon Command Options

-D	-nowait	-resevt	-allsnd	Actions
-D				When HORCM does not have an event, this option waits until an event occurs. If one or more events exist, it reports one event and resets the event which it reported.
Invalid			-allsnd	When HORCM does not have an event, this option waits until an event occurs. If one or more events exist, it reports all events.
Invalid		-resevt		When HORCM does not have an event, this option waits until an event occurs. If one or more events exist, it reports one event and resets all events.
Invalid		-resevt	-allsnd	When HORCM does not have an event, this option waits until an event occurs. If one or more events exist, it reports all events and resets all events.
Invalid	-nowait			When HORCM does not have an event, this option reports event nothing. If one or more events exist, it reports one event and resets the event which it reported.
Invalid	-nowait		-allsnd	When HORCM does not have an event, this option reports event nothing. If one or more events exist, it reports all events.
Invalid	-nowait	-resevt		When HORCM does not have an event, this option reports event nothing. If one or more events exist, it reports one event and resets all events.
Invalid	-nowait	-resevt	-allsnd	When HORCM does not have an event, this option reports event nothing. If one or more events exist, it reports all events and resets all events.

Checking attribute and status (pairvolchk)

The **pairvolchk** command acquires and reports the attribute of a volume or group connected to the local host (issuing the command) or remote host. The volume attribute is SMPL (simplex), P-VOL (primary volume), or S-VOL (secondary volume). The `-s[s]` option reports the pair status in addition to the attribute. [Table 1-10](#) lists and describes the pairvolchk command parameters and returned values. [Figure 1-26](#) shows an example of the pairvolchk command and its output. [Table 1-11](#) shows the truth table for pairvolchk group status display.

Table 1-10: Pairvolchk Command Parameters

Parameter	Value
Command Name	pairvolchk
Format	pairvolchk { -h -q -z -l[H M][instance#] -g <group> -d <pair Vol> -d[g] <raw_device> [MU#] -FHORC -FMRCF [MU#] -d[g] <seq#> <LDEV#> [MU#] -c -ss -nomsg }

Table 1-10: Pairvolchk Command Parameters (Continued)

Parameter	Value
Options	<p>-d[g] <seq#> <LDEV#> [MU#]: Searches a group on the configuration definition file (local instance) for the specified LDEV, and if the specified LDEV is contained in the group, the target volume is executed as the paired logical volume (-d) or group (-dg). This option is effective without specifying the "-g <group>" option. If the specified LDEV is contained in two or more groups, the command is executed on the first group. The <seq #> <LDEV #> values can be specified in hexadecimal (by addition of "0x") or decimal notation.</p> <p>-c: Checks the conformability of the paired volumes of the local and remote hosts and reports the volume attribute of the remote host. If this option is not specified, the volume attribute of the local host is reported.</p> <p>-ss: Used to acquire the pair status of a volume in addition to the volume attribute. If this option is not specified, only the volume attribute is reported.</p> <p>-nomsg: Suppresses messages to be displayed when this command is executed. It is used to execute a command from a user program. This option must be specified at the beginning of a command argument. The command execution log is not affected by this option.</p>
Returned values	<p>When the -ss option is not specified:</p> <p>Normal termination:</p> <ul style="list-style-type: none"> 1: The volume attribute is SMPL. 2: The volume attribute is P-VOL. 3: The volume attribute is S-VOL. <p>Abnormal termination: Returns a common error code and a unique error code for this command. For details on error codes, see Chapter 2, Troubleshooting.</p> <p>When the -ss option is specified:</p> <p>Normal termination:</p> <ul style="list-style-type: none"> 11: The status is SMPL. <p>For SnapShot:</p> <ul style="list-style-type: none"> 22: The status is PVOL_COPY or PVOL_RCPY. 23: The status is PVOL_PAIR. 24: The status is PVOL_PSUS. 25: The status is PVOL_PSUE. 28: The status is PVOL_PFUS. 32: The status is SVOL_COPY or SVOL_RCPY. 33: The status is SVOL_PAIR. 34: The status is SVOL_PSUS. 35: The status is SVOL_PSUE. 38: The status is SVOL_PFUS. 39: The status is SVOL_PFUS or SVOL_PSUS. <p>For TrueCopy and ShadowImage:</p> <ul style="list-style-type: none"> 22: The status is PVOL_COPY or PVOL_RCPY. 23: The status is PVOL_PAIR. 24: The status is PVOL_PSUS. 25: The status is PVOL_PSUE. 32: The status is SVOL_COPY or SVOL_RCPY. 33: The status is SVOL_PAIR. 34: The status is SVOL_PSUS. 35: The status is SVOL_PSUE. <p>For TCE:</p> <ul style="list-style-type: none"> 42: The status is PVOL_COPY. 43: The status is PVOL_PAIR. 44: The status is PVOL_PSUS. 45: The status is PVOL_PSUE. 48: The status is PVOL_PFUS. 52: The status is SVOL_COPY. 53: The status is SVOL_PAIR. 54: The status is SVOL_PSUS. 55: The status is SVOL_PSUE. 58: The status is SVOL_PFUS. <p>Abnormal termination: Returns a common error code and a unique error code for this command. For details on error codes, see Chapter 2, Troubleshooting.</p>

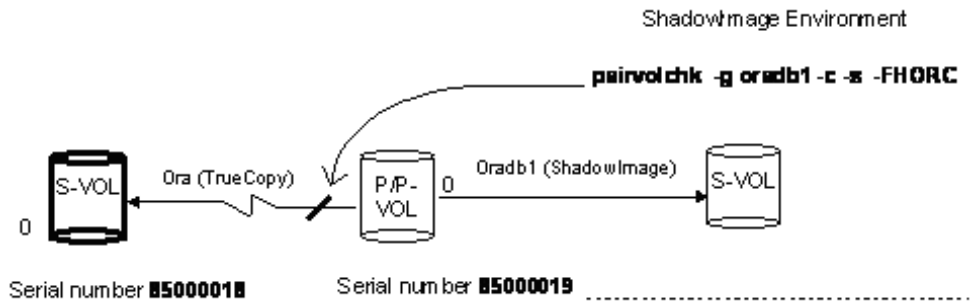

Figure 1-25: Example of -FHORC Option for Pairvolchk

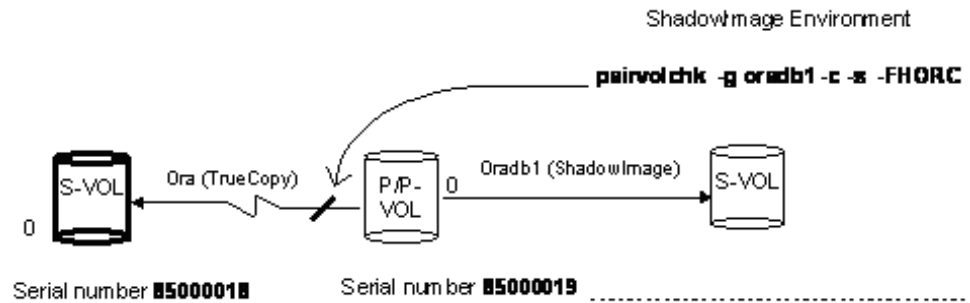

Figure 1-26: Example of -FMRCF Option for Pairvolchk

```
# pairvolchk -g ora
Pairvolchk : Volstat is S-VOL.[status = PAIR fence = ASYNC CTGID = 5 MINAP = 2 ]
```

Figure 1-27: Pairvolchk Command

The output of the pairvolchk command includes:

- **status:** Shows the status of paired volume. For the pair status in the case of specifying a group, refer to [Table 1-11](#).
- **fence:** Shows fence level.
- **CTGID:** Shows CTGID.
- **MINAP:** The number of active link paths of TrueCopy or TCE is shown on the P-VOL.

Table 1-11: Truth Table for Pairvolchk Group Status Display

Status of Each Volume in the Group						
Option	COPY*	PSUE	PFUS	PSUS	PAIR	Group Status
Note*	TRUE	x	x	x	x	COPY*
	false	TRUE	x	x	x	PSUE
	false	false	TRUE	x	x	PFUS

Table 1-11: Truth Table for Pairvolchk Group Status Display (Continued)

Status of Each Volume in the Group						
	false	false	false	TRUE	x	PSUS
	false	false	false	false	TRUE	PAIR
-ss	TRUE	x	x	x	x	COPY*
	false	TRUE	x	x	x	PSUE
	false	false	x	x	TRUE	PAIR
	false	false	TRUE	false	false	PFUS
	false	false	false	TRUE	false	PSUS

COPY* = COPY or RCPY

x = true or false (does not matter).



NOTE: A case where the pairvolchk -s command is executed with the setting of the environmental variable of USE_OLD_VCHK.

Displaying pair status (pairedisplay)

The **pairedisplay** command displays the pair status; this allows you to verify that pair operations are complete (that is, paircreate, pairresync). The pairedisplay command is also used to confirm the configuration of the pair connection path (the physical link of paired volumes and hosts). The pairedisplay command can be used for a paired volume or a group of paired volumes. [Table 1-12](#) lists and describes the pairedisplay command parameters and returned values. [Figure 1-28](#) shows examples of the pairedisplay command and its output.



NOTE: During the period until the response of the command is returned after the pair status change command such as pairsplit is executed, the pairedisplay command cannot be executed in the same screen. Therefore, start another screen and execute pairedisplay to check the pair status.

Table 1-12: Pairedisplay Command Parameters

Parameter	Value
Command Name	pairedisplay
Format	pairedisplay { -h -q -z -I[H M][instance#] -g <group> -d <pair Vol> -d[g] <raw_device> [MU#] -FHORC -FMRCF [MU#] -d[g] <seq#> <LDEV#> [MU#] -c -l -f[xcdew] -CLI -v smk -v pid -m <mode> }

Table 1-12: Pairedisplay Command Parameters (Continued)

Parameter	Value
Options	<p>-h: Displays help, usage, and version information.</p> <p>-q: Terminates the interactive mode and exits the pair volume check command.</p> <p>-z or -zx: Makes the pairedisplay command enter the interactive mode. The -zx option guards performing of the HORCM in the interactive mode. When this option detects a HORCM shut down, interactive mode terminates.</p> <p>-I[H M][instance#] or -I[TC SI][instance#]: Specifies the instance number and the command execution environment. Refer to Instance number and option for command execution environment on page 1-4.</p> <p>-g <group>: Specifies the group name defined in the configuration definition file. This option must always be specified. The command is executed for the specified group unless the -d <pair Vol> option is specified.</p> <p>-d <pair Vol>: This option is used to specify the paired logical volume name defined in the configuration definition file. When this option is specified, the command is executed for the specified paired logical volumes.</p> <p>-d[g] <raw_device> [MU#]: Searches a group on the configuration definition file (local instance) for the specified raw_device, and if the specified raw_device is contained in the group, the target volume is executed as the paired logical volume (-d) or group (-dg). This option is effective without specification of "-g <group>" option. If the specified the raw_device is contained in two or more groups, the command is executed on the first group.</p> <p>-FHORC or -FCA: Forcibly specifies a cascading TrueCopy or TCE volume for specified pair logical volumes in a ShadowImage or SnapShot environment. If the -I option is specified, this option displays status of a cascading TrueCopy or TCE volume on a local host. If no -I option is specified, this option displays status of a cascading TrueCopy or TCE volume on a remote host. This option cannot be specified with -m <mode> option on the same command line.</p> <p>-FMRCF [MU#] or -FBC [MU#]: Forcibly specifies a cascading ShadowImage or SnapShot volume for specified pair logical volumes on a TrueCopy or TCE environment. If the -I option is specified, this option displays status of a cascading ShadowImage or SnapShot volume on a local host. If no -I option is specified, this option displays status of a cascading ShadowImage or SnapShot volume on a remote host. This option cannot be specified with -m <mode> option on the same command line.</p> <p>-d[g] <seq#> <LDEV#> [MU#]: Searches a group on the configuration definition file (local instance) for the specified LDEV, and if the specified LDEV is contained in the group, the target volume is executed as the paired logical volume (-d) or group (-dg). This option is effective without specification of "-g <group>" option. If the specified LDEV is contained in two or more groups, the command is executed on the first group. The <seq #> <LDEV #> values can be specified in hexadecimal (by addition of "0x") or decimal notation.</p> <p>-c: Checks the configuration of the paired volume connection path (physical link of paired volume among the hosts) and displays illegal pair configurations. If this option is not specified, the status of the specified paired volume is displayed without checking the path configuration.</p> <p>-l: Displays the paired volume status of the local host (which issues this command). -fc: Displays the copy operation progress (or the pair consistency rate), and whether if the use rate of the data pool has reached its threshold. This option also shows the PFUS status of the SnapShot pairs.</p>

Table 1-12: Pairedisplay Command Parameters (Continued)

Parameter	Value
Options (continued)	<p>-fx: Displays the LDEV ID as a hexadecimal number.</p> <p>-fd: Displays the group-based device file of the configuration file registered in HORCM and the relation between the groups. If Unknown is displayed in the DEVICE_FILE shown below, the pair operation (except for the local option) is rejected as protection mode because the volume is not registered.</p> <p>Example:</p> <pre># pairedisplay -g oradb -fd Group PairVol(L/R) Device_File M,Seq#,LDEV#.P/S,Status, Seq#,P-LDEV# M oradb oradb1(L) Harddisk1 0 85005013 17.P-VOL COPY,85005013 18 - oradb oradb1(R) Unknown 0 85005013 ****.-----, ----- -</pre> <p>-fe: Displays discrimination between a SnapShot volume and a ShadowImage volume and a number of active link paths, and so on by adding them as the last column. The 80-column format of 80 is neglected. This option will be invalid if the cascade options (-m all) are specified.</p> <p>-fw: Used to display the WWN setting to the port instead of a port name. If this option is specified with "-fe" option at the same line, then "LUN WWN" is displayed as shown below. If WWN is not computed, then "Unknown" is displayed.</p> <p>Example:</p> <pre># pairedisplay -g oradb -fw # pairedisplay -g oradb -w Group PairVol(L/R)(WWN , LU-M) ,Seq#,LDEV#.P/S,Status, Seq#,P-LDEV# M oradb oradev1(L)(50060e8010200650, 21-0)85000101 21.P-VOL PSUS,85000101 20 W oradb oradev1(R)(50060e8010200654, 20-0)85000101 20.S-VOL SSUS,----- 21 W # pairedisplay -g oradb -fwe Group PairVol(L/R)(WWN , LU-M) ,Seq#,LDEV#.P/S,Status, Seq#,P-LDEV# M CTG CM EM E-Seq# E-LDEV# LUN-WWN oradb oradev1(L)(50060e8010200650, 21-0)85000101 21.P-VOL PSUS,85000101 20 W - N - - 60060e80102006500510ffa500000014 oradb oradev1(R)(50060e8010200654, 20-0)85000101 20.S-VOL SSUS,----- 21 W - N - - 60060e80102006500510ffa500000015</pre> <p>-CLI: Used to specify display for command line interface (CLI). This option displays to the same position that defined number of columns, and displays one header. The delimiters between columns are displayed as spaces or hyphens (-). Display example:</p> <pre># pairedisplay -g homrcf1 -CLI Group PairVol L/R Port# TID LU-M Seq# LDEV# P/S Status Seq# P-LDEV# M homrcf1 deva0 L CL1-A 3 5 0 85003005 5 P-VOL PAIR 85003005 3 - homrcf1 deva1 L CL1-A 3 5 0 85003005 5 SMPL - - - - homrcf1 deva2 L CL1-A 3 5 0 85003005 5 SMPL - - - -</pre> <p>-v smk (for SnapShot): This option displays the time (UTC) when the Split-Marker (a character string with 31 or less characters) is added to the V-VOL and the Split-Marker as an execution result only for the SnapShot pair that has been split by the pairsplit -ms command.</p> <p>-v pid (for SnapShot only): This option displays the pair volume name or the information on the pool which the pair specified by <raw_device> uses. The information on the pool of the local side is displayed on the 1st line, and the information on the pool of the remote side is displayed on the 2nd line. If executing it to the SnapShot pair, the displays of the 1st line and the 2nd line become equal.</p>

Table 1-12: Pairedisplay Command Parameters (Continued)

Parameter	Value
Options (continued)	<p>Note: This option displays nothing if the target volume is NOT SnapShot volume.</p> <p>-m <mode>: Used to display a paired status of each mirror descriptors for the specified pair logical volume, and used for paired status indication of the cascading volume. <mode> option can be designated "all " (see Figure 1-29):. The "all" option is used to display a paired status of all mirror descriptors (MU#).</p>
Returned Values	<p>Normal termination: 0</p> <p>Abnormal termination: Returns a common error code for this command. For details on error codes, see Chapter 2, Troubleshooting.</p>

```
# pairedisplay -g oradb
Group   PairVol(L/R) (Port#,TID, LU-M) ,Seq#,LDEV#.P/S,Status, Seq#,P-LDEV# M
oradb   oradb1(L)  (CL1-A , 1,  1-0 )85003005    1.P-VOL COPY,85003005    19 -
oradb   oradb1(R)  (CL1-A , 2,  1-0 )85003005    1.S-VOL COPY,-----    18 -
```

Figure 1-28: Pairedisplay Command

The output of the pairedisplay command includes:

- **Group**: Shows the group name (dev_group) described in the configuration definition file.
- **Pair Vol(L/R)**: Shows the paired volume name (dev_name) described in the configuration definition file. (L) indicates the local host; (I) indicates the remote host.
- **(Port#,TID,LU) (TrueCopy/TCE)**: Shows the port number, target ID and LU number as described in the configuration definition file.
- **(Port#,TID,LU-M) (ShadowImage/SnapShot)**: Shows the port number, target ID, LU number, and MU number as described in the configuration definition file.
- **Seq#**: Shows the serial number of the array.
- **LDEV#**: Shows the logical device number. LDEV indicates LU.
- **P/S**: Shows the volume attribute.
- **Status**: Shows the status of the paired volume.
- **Fence (for TrueCopy/TCE)**: Shows fence level.
- **%**: Shows copy operation completion or percent pair synchronization.

State	ShadowImage/ SnapShot			TrueCopy			TCE			
	VOL.	COPY	PAIR	OTHER	COPY	PAIR	OTHER	COPY	PAIR	OTHER
P-VOL	CR	CR	CR	CR	BMP	BMP	CR	UnBMP	BMP	
S-VOL	CR	CR	CR	-	BMP	BMP	-	UnBMP	BMP	

CR: Shows the copy operation rate (identical rate of a pair).

BMP: Shows the identical percentage of BITMAP for both P-VOL and S-VOL.

UnBMP: Shows the inconsistent percentage of BITMAP for both P-VOL and S-VOL.

When the paircreate or pairresync command is executed, the pair undergoes the full copy or differential copy in the COPY status, undergoes the cyclic copy once, and then placed in the PAIR status. When a new pair is added to a CTG, which is already placed in the PAIR status, by the paircreate or pairresync command, the copy operation halts until the time of the existing cyclic copy after the full copy or differential copy is completed. Further, it is not placed in the PAIR status until the first cyclic copy is completed after it begins to act in time to the cycle. Therefore, the pair synchronization rate displayed by Navigator 2 or CCI may be 100% or not changed when the pair status is COPY.

- **P-LDEV#:** Shows the LDEV number of the partner volume of the pair.
- **M:**
 - **M = W** (PSUS only): For P-VOLs, shows suspension with the S-VOL read/write enabled. For S-VOLs, shows that write I/Os were accepted at the S-VOL.
 - **M = N** (COPY, PAIR, PSUE, PSUS only): Shows that read access is disabled. At this time, make sure of the pair, which is displayed by Navigator 2, status of which is PSUS (PSUS(N)), and no reading/writing from/to which is allowed.

Figure 1-29 shows examples of the **-m** option of the pairdisplay command.

Display examples for **-m all**:

```
# pairdisplay -g oradb -m all
Group  PairVol(L/R) (Port#,TID, LU-M) ,Seq#,LDEV#.P/S,Status, Seq#,P-LDEV# M
oradb  oradev1(L) (CL1-A , 3, 0-0 )85003005 0.SMPL ----, ---- ---- -
oradb  oradev1(L) (CL1-A , 3, 0-0 )85003005 0.P-VOL PAIR,85003005 26 -
oradb1 oradev11(R) (CL1-A , 3, 2-0 )85003005 2.P-VOL COPY,85003005 27 -
oradb  oradev1(R) (CL1-A , 3, 2-0 )85003005 2.S-VOL COPY, ---- 25 -
# pairdisplay -d Harddisk1 -l -m all
Group  PairVol(L/R) (Port#,TID, LU-M) ,Seq#,LDEV#.P/S,Status, Seq#,P-LDEV# M
oradb  oradev1(L) (CL1-A , 3, 0-0 )85003005 0.SMPL ----, ---- ---- -
oradb  oradev1(L) (CL1-A , 3, 0-0 )85003005 0.P-VOL PAIR,85003005 26 -
```

Figure 1-29: Pairdisplay Command -m Option shows examples of the -fe option of the pairdisplay command.

Figure 1-30, Figure 1-31, and Figure 1-32 show examples of the **-fe** option of the pairdisplay command.

```
# pairdisplay -g vg01 -fe
Group  PairVol(L/R) (Port#,TID, LU-M) ,Seq#,LDEV#.P/S,Status, Seq#,P-LDEV# M CTG CM EM E-Seq#
E-LDEV#
vg01  oradb1(L) (CL1-A , 1, 5-0 )85000004 5.P-VOL PSUS,85000004 6 W - S - - -
vg01  oradb1(R) (CL1-A , 1, 6-0 )85000004 6.S-VOL PSUS,----- 5 - - S - - -
vg01  oradb2(L) (CL1-A , 1, 2-0 )85000004 2.P-VOL PSUS,85000004 3 W - N - - -
vg01  oradb2(R) (CL1-A , 1, 3-0 )85000004 3.S-VOL PSUS,----- 2 - - N - - -
```

Figure 1-30: Pairdisplay Command -fe Option (ShadowImage and SnapShot)

```
# pairdisplay -g vg01 -fe
Group  PairVol(L/R)  .... P-LDEV#  M CTG JID AP EM E-Seq# E-LDEV# R/W
vg01   oradb1(L)     .... 1      - - - 2 - - - -/-
vg01   oradb1(R)     .... 1      - - - 2 - - - -/-
```

Figure 1-31: Pairdisplay Command -fe Option (TrueCopy)

```
# pairdisplay -g vg01 -fe
Group  PairVol(L/R)  .... P-LDEV#  M CTG JID AP EM E-Seq# E-LDEV# R/W
vg01   oradb1(L)     .... 1      - 1 - 2 - - - -/-
vg01   oradb1(R)     .... 1      - 1 - 2 - - - -/-
```

Figure 1-32: Pairdisplay Command -fe Option (TCE)

The output of the pairdisplay command includes:

- **CTG:** Shows the CTG ID.
- **JID:** Shows "-".
- **AP:** Shows the number of active link paths of TrueCopy or TCE on the P-VOL.
- **CM:** Shows copy mode:
 - N: Non-snap shot volume (ShadowImage)
 - S: Snap shot volume (SnapShot)
- **EM, E-Seq#, E-LDEV#:** Shows "-". [Figure 1-33](#) shows examples of the **-v smk** option of the pairdisplay command.
- **R/W:?** Shows "-".

```
# pairdisplay -g vg01 -v smk
Group  PairVol(L/R)  Serial# LDEV# P/S Status UTC-TIME -----Split-Marker-----
vg01   oradb1(L)     85000004 5 P-VOL PSUS - -
vg01   oradb1(R)     85000004 6 S-VOL SSUS 123456ef QS_Check_12345678
```

Figure 1-33: Pairdisplay Command -v smk Option (SnapShot)

The output of the pairdisplay command includes:

- **UTC-TIME:** The UTC when the Split-Marker was added to the V-VOL is displayed.
- **Split-Marker:** The Split-Marker added to the V-VOL is displayed. When the pair concerned is the SnapShot pair that was split by the pairsplit **-ms** command, the Split-Marker is displayed as information on the V-VOL.

[Figure 1-34](#) shows examples of the **-v pid** option of the pairdisplay command.

```

# pairdisplay -g vg01 -v pid
PID POLS U(%) SSCNT Available(MB) Capacity(MB) Seq# Num LDEV# H(%)
127 POLN 0 6 3000 3000 85000004 2 200 80
127 POLN 0 6 3000 3000 85000004 2 200 80

# pairdisplay -g vg01 -v pid -l
PID POLS U(%) SSCNT Available(MB) Capacity(MB) Seq# Num LDEV# H(%)
127 POLN 0 6 3000 3000 85000004 2 200 80

```

Figure 1-34: Pairdisplay Command -v pid Option

The output of the pairdisplay command with `-v pid` includes:

- **PID:** Shows the pool ID.
- **POLS:** The status of the pool is shown as below.
POLN: Shows that the status of the pool is normal.
POLF: Shows that the usage rate of the pool exceeds the set threshold value.
- **U(%):** The whole capacity of the pool is made into 100% and the usage rate is shown.
- **SSCNT:** Shows the number of SnapShot Volume (V-VOL) in the pool.
- **Available(MB):** Shows the available capacity for the volume data on the pool (in MB).
- **Capacity(MB):** Shows the total capacity in the pool (in MB).
- **Seq#:** Shows the serial number of the array.
- **Num:** Shows the number of LU configured the pool.
- **LDEV:** Shows the first number of LU configured the pool.
- **H(%):** Shows the threshold rate being set to the pool as High water mark. 'Unknown' will be shown as '-'

Checking pair currency (paircurchk)

The TrueCopy or TCE paircurchk command checks the currency of the TrueCopy or TCE secondary volumes by evaluating the data consistency based on pair status and fence level. [Table 1-13](#) specifies the data consistency for each possible state of a TrueCopy or TCE volume. A paired volume or group can be specified as the target of the paircurchk command. The paircurchk command assumes that the target is an S-VOL. If the paircurchk command is specified for a group, the data consistency of each volume in the group is checked, and all inconsistent volumes are found in the execution log file and displayed. Paircurchk is also executed as part of the TrueCopy or TCE horctakeover command (see next section).

TrueCopy and TCE support the paircurchk command. The paircurchk command may be executed in the cases where it is performed by you specification and the SVOL_Takeover processing by the horctakeover command.

Table 1-13: Data Consistency Displayed by the Paircurchk Command

Object Volume			Paircurchk	
Attribute	Status	Fence	User Specification	SVOL_Takeover Processing
SMPL	-	-	To be confirmed	(Not executed)
P-VOL	-	-	To be confirmed	(Not executed)
S-VOL	COPY	Data	Inconsistent	Inconsistent
		Never		
		Async		
	PAIR	Data	OK	OK
		Never	To be analyzed	To be analyzed
		Async	To be analyzed	OK
	PSUS	Data	Suspected	Suspected
		Never		
		Async		
	PSUS(N)	Async	Suspected	Inconsistent
	PFUS	Async	Suspected	OK
	PSUE	Data	OK	OK
		Never	Suspected	Suspected
		Async		OK
	SSWS	Async	Suspected	(Not executed)

- **To be confirmed:** It is necessary to check the object volume, since it is not the secondary volume.
- **Inconsistent:** Data in the volume is inconsistent because it was being copied. Therefore the SVOL-takeover is not executed.
- **To be analyzed:** Whether S-VOL has a mirror consistency or not cannot be judged by the status of S-VOL. If the status of P-VOL is PAIR, the mirror consistency is OK. If the status of P-VOL is PSUS or PSUE, the mirror consistency is suspected.
- **Suspected:** S-VOL has no mirror consistency.
- **OK:** Mirroring consistency is assured in TrueCopy. Mirroring consistency is not assured in TCE.

Table 1-14: Paircurchk Command Parameters

Parameter	Value
Command Name	paircurchk
Format	paircurchk { -h -q -z -I[H M][instance#] -g <group> -d <pair Vol> -d[g] <raw_device> [MU#] -d[g] <seq#> <LDEV#> [MU#] -nomsg }
Options	<p>-h: Displays help, usage, and version information.</p> <p>-q: Terminates the interactive mode and exits the command.</p> <p>-z or -zx: Makes the raidscan command enter the interactive mode. The -zx option guards performing of the HORCM in the interactive mode. When this option detects a HORCM shut down, interactive mode terminates.</p> <p>-I[H M][instance#] or -I[TC SI][instance#]: Specifies the instance number and the command execution environment. Refer to Instance number and option for command execution environment on page 1-4.</p> <p>-g <group>: Specifies the group name defined in the configuration definition file. This option must always be specified. The command is executed for the specified group unless the -d <pair Vol> option is specified. In the case of TCE, the horctakeover command is executed for each CTG, however, the paircurchk command is executed for the specified group.</p> <p>-d <pair Vol>: This option is used to specify the paired logical volume name defined in the configuration definition file. When this option is specified, the command is executed for the specified paired logical volumes.</p> <p>-d[g] <seq#> <LDEV#> [MU#]: Searches a group on the configuration definition file (local instance) for the specified LDEV, and if the specified LDEV is contained in the group, the target volume is executed as the paired logical volume (-d) or group (-dg). This option is effective without specification of “-g <group>” option. If the specified LDEV is contained in two or more groups, the command is executed on the first group. The <seq #> <LDEV #> values can be specified in hexadecimal (by addition of “0x”) or decimal notation.</p> <p>-nomsg: Suppresses messages to be displayed when this command is executed. It is used to execute a command from a user program. This option must be specified at the beginning of a command argument. The command execution log is not affected by this option.</p>
Returned values	<p>Normal termination: 0</p> <p>Abnormal termination: Returns a common error code and a unique error code for this command. For details on error codes, see Chapter 2, Troubleshooting.</p>

```
# paircurchk -g oradb
paircurchk : Volume currency error.
Group Pair vol Port targ# lun# LDEV#...P/S Status Fence To be...
oradb oradb1 CL1-A 1 5 30...SMPL ... Confirmed
paircurchk: [EX_VOLCUR] S-Vol currency error
```

Figure 1-35: Paircurchk Command

The output of the paircurchk command includes:

- **Group**: Shows the group name (dev_group) described in the configuration definition file.
- **Pair Vol**: Shows the paired volume name (dev_name) described in the configuration definition file.

- **Port#, targ#, lun#:** Shows the port number, target ID, and LU number as described in the configuration definition file.
- **LDEV#:** Shows the logical device number. LDEV indicates LU.
- **P/S:** Shows the volume attribute.
- **Status:** Shows the status of the paired volume.
- **Fence:** Shows the fence level.
- **To be...:** Evaluating the mirror consistency of S-VOL shows the currency of the volume.

Performing takeover operations (horctakeover)



Note 1: When the array to be used is changed to the remote one by the horctakeover command, the local array is placed in the PSUE status depending on the time when the change is made because of a collision with an I/O instruction issued by a host to the local array. This status transition occurs because the change is untimely. However, even if this occurs, reading to and writing from an S-VOL of the remote array can be done because the horctakeover command keeps the S-VOL in the PSUS status (SSWS).

Note 2: In the case of TrueCopy, when the horctakeover command is issued to the remote array, there may be a rare case where the SWAP-Takeover fails and terminates in the SVOL-Takeover status because of a load of the other CCI command on the local array added to a load of the horctakeover command. However, even if this occurs, the S-VOL is kept in the PSUS status (SSWS) and reading to it and writing from it can be done. Besides, a swap between a primary and secondary volume can be done when it is possible after statuses of the local and remote arrays are checked and the pairresync –swaps command is executed for the remote array.

Note 3: When the –d option is specified in the case of TCE, only an S-VOL of the target pair is placed in the SSWS status. Besides, at this time, all the other pairs in the same CTG are not kept paired. When a P-VOL was in the PAIR status before the command was accepted, it is placed in the PSUE status because the pair created of it and an S-VOL is split forcibly. On the other hand, statuses of the other S-VOLs in the CTG are not changed and kept as PAIR because the communication from the primary array is cut off

The horctakeover command is a scripted command for executing several HORC operations. The horctakeover command checks the specified volume's or group's attributes (paircurchk), decides the takeover function based on the attributes, executes the chosen takeover function, and returns the result. The four TrueCopy takeover functions designed for HA software operation are: takeover-switch, swap-takeover, PVOL-takeover, and SVOL-takeover. TCE takeover function designed for HA software operation is SVOL-takeover only. A paired volume or a group can be specified as the target of the TrueCopy or TCE horctakeover command. If TrueCopy or TCE SVOL-takeover is specified for a group, the data consistency check is

executed for all volumes in the group, and all inconsistent volumes are found in the execution log file and displayed (same as paircurchk command).

The horctakeover command allows swapping of the primary and secondary volumes, so that if the primary or secondary volume is switched due to a server error or package transfer, duplex operations can be continued using the reversed volumes. When control is handed over to the current node, swapping the volumes again deletes the need to copy them. The horctakeover command also allows the secondary volume to be separated for disaster recovery operations.

Figure 1-15 lists and describes the TrueCopy or TCE horctakeover command parameters and returned values.

Table 1-15: Horctakeover Command Parameters

Parameter	Value
Command Name	horctakeover
Format	horctakeover { -h -q -z -I[H M][instance#] -g <group> -d <pair Vol> -d[g] <raw_device> [MU#] -d[g] <seq#> <LDEV#> [MU#] -S -I -t <timeout> -nomsg }
Options	<p>-h: Displays help, usage, and version information.</p> <p>-q: Terminates the interactive mode and exits the command.</p> <p>-z or -zx: Makes the raidscan command enter the interactive mode. The -zx option guards performing of the HORCM in the interactive mode. When this option detects a HORCM shut down, interactive mode terminates.</p> <p>-I[H M][instance#] or -I[TC SI][instance#]: Specifies the instance number and the command execution environment. Refer to Instance number and option for command execution environment on page 1-4.</p> <p>-g <group>: Specifies the group name defined in the configuration definition file. This option must always be specified. The command is executed for the specified group unless the -d <pair Vol> option is specified.</p> <p>-d <pair Vol>: This option is used to specify the paired logical volume name defined in the configuration definition file. When this option is specified, the command is executed for the specified paired logical volumes.</p> <p>-d[g] <raw_device> [MU#]: Searches a group on the configuration definition file (local instance) for the specified raw_device, and if the specified raw_device is contained in the group, the target volume is executed as the paired logical volume (-d) or group (-dg). This option is effective without specification of "-g <group>" option. If the specified the raw_device is contained in two or more groups, the command is executed on the first group.</p> <p>-d[g] <seq#> <LDEV#> [MU#]: Searches a group on the configuration definition file (local instance) for the specified LDEV, and if the specified LDEV is contained in the group, the target volume is executed as the paired logical volume (-d) or group (-dg). This option is effective without specification of "-g <group>" option. If the specified LDEV is contained in two or more groups, the command is executed on the first group. The <seq #> <LDEV #> values can be specified in hexadecimal (by addition of "0x ") or decimal notation.</p> <p>-S: Selects and executes SVOL-takeover. The target volume of the local host must be an S-VOL. If this option is specified, then the following "-I" option is invalid.</p>

Table 1-15: Horctakeover Command Parameters (Continued)

Parameter	Value
Options (continued)	<p>-l: Enables read and write to the primary volumes by a local host only without a remote host, and executes PVOL-takeover when the primary volume cannot be used because it is fenced (fence = DATA, state = PSUE, or PSUE volume is contained in the group). If the primary volume can be accessed, nop- takeover is executed. The target volume of the local host must be a P-VOL.</p> <p>-t<timeout>: Must be specified for async volumes only (TCE), ignored for sync. Specifies the maximum time to wait (in seconds) for swap-takeover and SVOL-takeover operation to synchronize the P-VOL and S-VOL. If this timeout occurs, the horctakeover command fails with EX_EWSTOT. To avoid timeout, set this value less than or equal to the start-up timeout value of the HA Control Script.</p> <p>-nomsg: Suppresses messages to be displayed when this command is executed. It is used to execute a command from a user program. This option must be specified at the beginning of a command argument. The command execution log is not affected by this option.</p>
Returned values	<p>Normal termination:</p> <ul style="list-style-type: none"> 0: Nop-takeover (no operation). 1: Swap-takeover was successfully executed. 2: SVOL-takeover was successfully executed. 3: PVOL-SMPL-takeover was successfully executed. 4: PVOL-PSUE-takeover was successfully executed. 5: SVOL-SSUS-takeover was successfully executed. <p>Abnormal termination: other than 0-5, Returns a common error code and a unique error code for this command. For details on error codes, see Chapter 2, Troubleshooting.</p>



NOTE: During TrueCopy or TCE pair operation, there are cases where pair operation fail when high volume host I/O or frequent change of pair status is occurring on both local and remote array. If pair operation fails and state transition is not done, then retry the pair operation (pairvolchk command can be used to check the state transition). When some of the pair operators fail, it is required to perform the pair operation for each logical volume pair in the group.

Horctakeover command functions

ShadowImage and SnapShot does not support this command.

Takeover-switch function

The control scripts activated by the HA software are used the same way by all nodes of a cluster; they do not discriminate between primary and secondary volumes. The horctakeover command, when activated by a control script, checks the combination of attributes of the local and remote volumes and determines the proper takeover action. [Table 1-16](#) lists the volume attributes and specifies the TrueCopy takeover action for each combination of attributes. [Table 1-17](#) lists the volume attributes and specifies the TCE takeover action for each combination of attributes.

Table 1-16: Volume Attributes and Takeover Actions (TrueCopy)

Local Node (Takeover Node)		Remote Node		Takeover Action	
Volume Attribute	Fence Level and Status	Volume Attribute	P-VOL Status		
SMPL	-	SMPL	-	NG ^[1]	
		P-VOL	-	Nop-Takeover ^[2]	
		S-VOL	-	Volumes not conform ^[3]	
		Unknown ^[4]	-	NG	
P-VOL (primary)	Fence = Data and Status = PSUE	SMPL	-	NG	
		P-VOL	-	Volumes not conform	
		S-VOL	-	PVOL-Takeover	
		Unknown Status (that is LAN down)	-	PVOL-Takeover	
	Fence = Never or Status = others	SMPL		NG	
		P-VOL		Volumes not conform	
		S-VOL		Nop-Takeover	
		Unknown Status (that is LAN down)		Nop-Takeover	
S-VOL (secondary)	Status = SSWS ^[5] After SVOL_SSUS-takeover	Any	-	Nop-Takeover	
	Others	SMPL	-	Volumes not conform	
		P-VOL	PAIR		Swap-Takeover
			Others		SVOL-Takeover
		S-VOL	-	Volumes not conform	
Unknown	-	SVOL-Takeover			

Table 1-17: Volume Attributes and Takeover Actions (TCE)

Local Node (Takeover Node)		Remote Node		Takeover Action	
Volume Attribute	Fence Level and Status	Volume Attribute	P-VOL Status		
SMPL	-	SMPL	-	NG ^[1]	
		P-VOL	-	Nop-Takeover ^[2]	
		S-VOL	-	Volumes not conform ^[3]	
		Unknown ^[4]	-	NG	
P-VOL (primary)	Fence = Async	SMPL	-	NG	
		P-VOL	-	Volumes not conform	
		S-VOL	-	Nop-Takeover	
		Unknown	-	Nop-Takeover	
S-VOL (secondary)	Fence = Async and Status = SSWS	-	-	Nop-Takeover	
		Fence = Async and Status = PSUS(N)	-	NG	
		Fence = Async and Status = COPY	-	NG	
		Others	SMPL	-	Volumes not conform
	Others	P-VOL	PAIR		SVOL-Takeover
			Others		SVOL-Takeover Note 2
		S-VOL	-	Volumes not conform	
		Unknown	-	SVOL-Takeover Note 2	

- **NG:** The horctakeover command is rejected, and the operation terminates abnormally.
- **Nop-Takeover:** The horctakeover command is accepted, but no operation is performed.
- **Volumes not conform:** The volumes are not in sync, and the horctakeover command terminates abnormally.
- **Unknown:** The remote node attribute is unknown and cannot be identified. The remote node system is down or cannot communicate.
- **SSWS:** Suspend for Swapping with S-VOL side only. The SSWS state is displayed as SSUS (SVOL_PSUS) by ALL commands except the -fc option of the pairdisplay command.

When the attribute of the self-node volume is SSUS, the target displays the NG message but the status changes to SSWS.

Swap-takeover function

When the P-VOL status of the remote node is PAIR and the S-VOL data is consistent, it is possible to swap the primary and secondary volumes. Therefore, when the P-VOL status of the remote node is PAIR, the swap-takeover function can be executed. The swap-takeover function is used by the HA control script when a package is manually moved to an alternate data center while all hardware is operational. Swap-takeover can be specified for a paired volume or a group.

The swap-takeover function internally executes the following commands to swap the primary and secondary volumes:

1. Execute **Suspend for Swapping** for the local volume (S-VOL). If this step fails, swap-takeover is disabled and an error is returned.
2. Execute **Resync for Swapping** to switch to the primary volume for which the local volume (S-VOL) is swapped as the NEW_P-VOL. Re-synchronizes the NEW_S-VOL based on the NEW_P-VOL. As for copy pace, if the remote host is known, the command will use the value of P-VOL specified at paircreate time. If the remote host is unknown, the command will use the default number of pace (three). If this step fails, swap-takeover returns at **SVOL-SSUS-takeover**, and the local volume (S-VOL) is maintained in SSUS(PSUS) state which allows and keeps track of write I/Os using a bitmap for the S-VOL. This special state is displayed as **SSWS** using the **-fc** option of the pairdisplay command.



NOTE: The swap-takeover function does not use **SMPL** or **No Copy** mode for swapping to guarantee mirror consistence. This is included as a function of SVOL-takeover.

SVOL-takeover function

The SVOL-takeover function allows the takeover node to use the secondary volume (except in COPY state) in SSUS (PSUS) state (that is, reading and writing are enabled), on the assumption that the remote node (possessing the primary volume) cannot be used. The data consistency of the TrueCopy S-VOL is evaluated by its pair status and fence level (same as paircurchk). If the primary and secondary volumes are not consistent, the SVOL-takeover function fails. If primary and secondary volumes are consistent, the SVOL-takeover function attempts to switch to the primary volume using **Resync for Swapping**. If successful, the SVOL-takeover function returns **Swap-takeover** as the return value of the horctakeover command. If not successful, the SVOL-takeover function returns **SVOL-SSUS-takeover** as the return value of the horctakeover command. In case of a host failure, **Swap-takeover** is returned. In case of P-VOL site failure, **SVOL-SSUS-takeover** is returned.

SVOL-takeover can be specified for a paired volume or a group. If the SVOL-takeover is specified for a group, a data consistency check is executed for all volumes in the group, and all inconsistent volumes are displayed (see [Table 1-13](#)).

PVOL-takeover function (TrueCopy only)

The PVOL-takeover function releases the pair state as a group, since that maintains the consistency of the secondary volume at having accepted horctakeover command when the primary volume is fenced ("data" and "PSUE" state, "PSUE" volume are contained in the group). This function allows the takeover node to use the primary volume (that is, reading and writing are enabled), on the assumption that the remote node (possessing the secondary volume) cannot be used. PVOL-takeover can be specified for a paired volume or a group.

The PVOL-takeover function executes the following two commands:

- **PVOL-PSUE-takeover:** Changes the primary volume to the suspend (PSUE, PSUS) state which enables write I/Os to all primary volumes of the group. The action of the PVOL-PSUE-Takeover causes PSUE, PSUS, or both PSUE and PSUS to be intermingled in the group. This intermingled pair status is PSUE as the group status; therefore, pairvolchk command returned gives priority to PSUE rather than PSUS as the group status. This special state turns back to the original state when the pairresync command is issued.
- **PVOL-SMPL-takeover:** Changes the primary volume to the simplex (SMPL) state. First, PVOL-takeover executes PVOL-PSUE-takeover further than PVOL-SMPL-takeover. If the PVOL-PSUE-takeover function fails, the PVOL-SMPL-takeover function is executed.

Applications of the horctakeover command

The basic TrueCopy or TCE commands (takeover, pair creation, pair splitting, pair resynchronization, event waiting) can be combined to enable recovery from a disaster, backup of paired volumes, and many other operations (that is, restoration of paired volumes based on the secondary volume, swapping of the paired volumes). [Figure 1-36](#) illustrates the flow of starting operations on a UNIX server at the secondary site using the TrueCopy or TCE horctakeover command.

[Figure 1-37](#) illustrates the flow of starting operations on a Windows 2000 or Windows Server server at the secondary site using the TrueCopy or TCE horctakeover command.

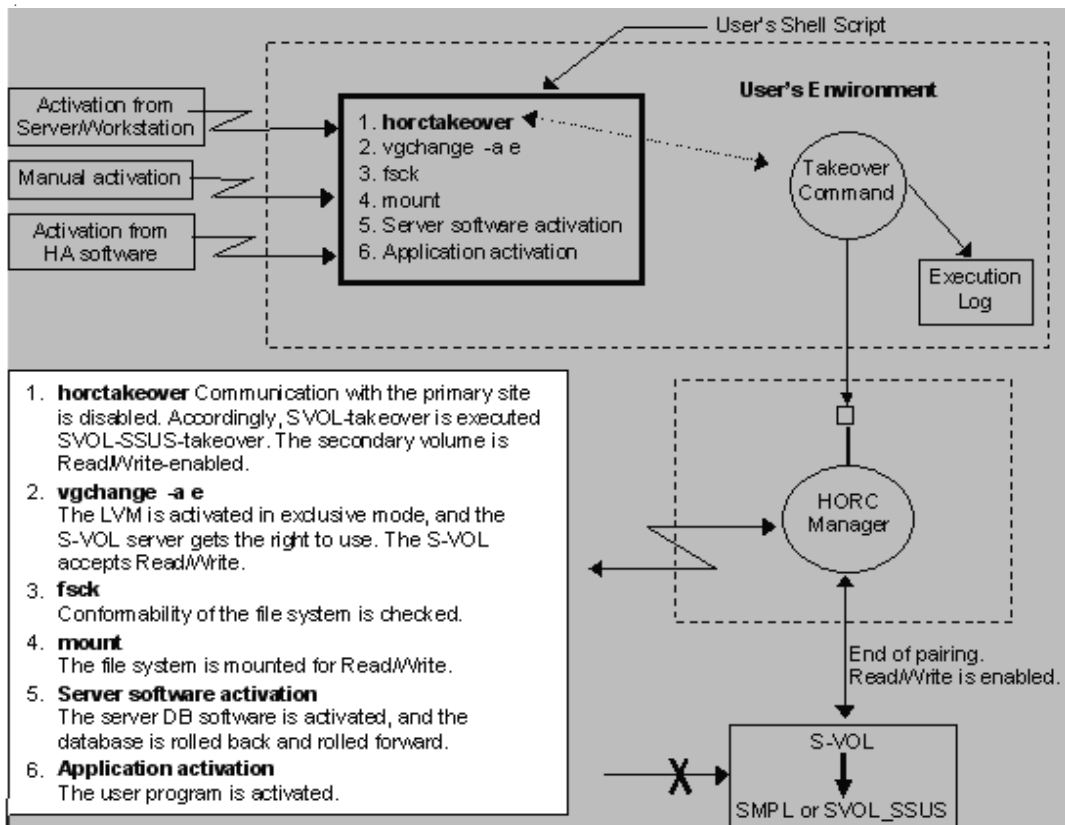

Figure 1-36: TrueCopy or TCE Takeover Example (UNIX System)

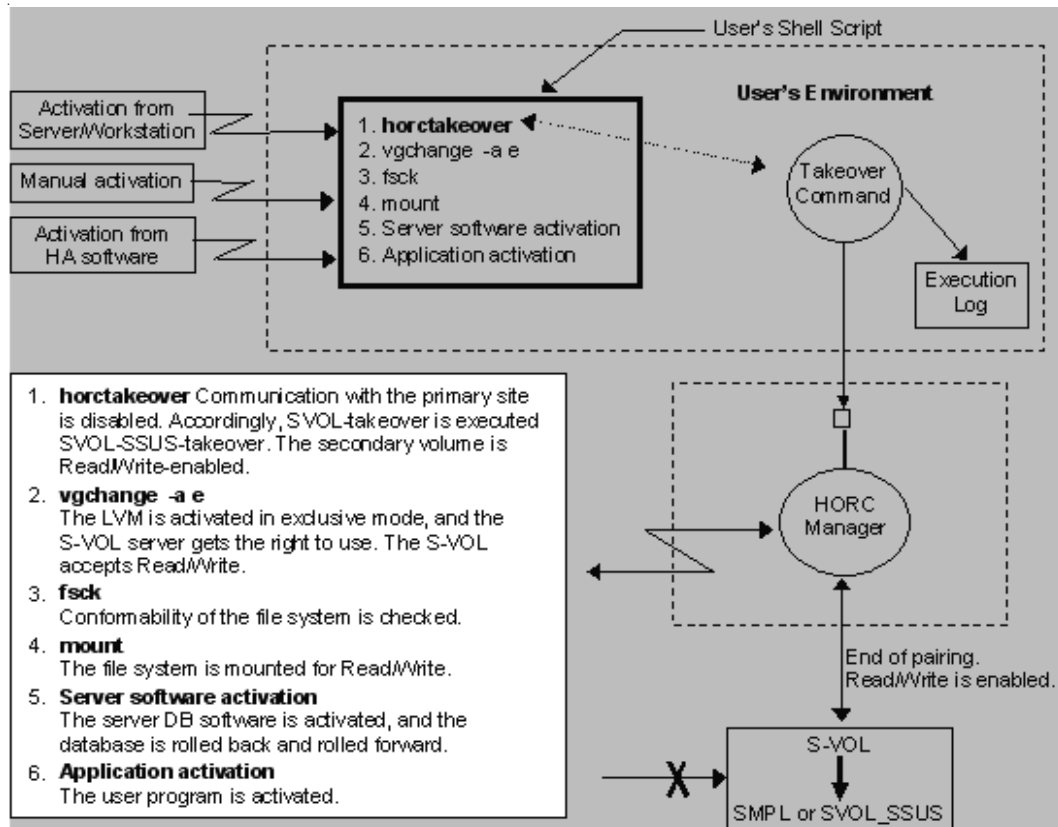

Figure 1-37: TrueCopy or TCE Takeover Example (Windows System)

Displaying configuration information

Raidscan command

The **raidscan** command displays configuration and status information for the specified array port, TIDs, or devices. The information is acquired directly from the array (not the configuration definition file). [Table 1-18](#) lists and describes the raidscan command parameters. [Figure 1-38](#) through [Figure 1-44](#) show examples of the raidscan command and its output. Note that LDEV indicates LU.

Table 1-18: Raidscan Command Parameters

Parameter	Value
tCommand Name	raidscan
Format	raidscan { -h -q -z -I[H M][instance#] -p <port> [hgrp] -pd[g] <raw_device> -s <Seq#> -t <targ> -l <lun> [-f[xfgde]] -CLI -find[g] [op] [MU#] [-g group] -pi <strings> -m<mun> }
Options	<p>-h: Displays help, usage, and version information.</p> <p>-q: Terminates the interactive mode and exits the command.</p> <p>-z or -zx: Makes the raidscan command enter the interactive mode. The -zx option guards performing of the HORCM in the interactive mode. When this option detects a HORCM shut down, interactive mode terminates.</p> <p>-I[H M][instance#] or -I[TC SI][instance#]: Specifies the instance number and the command execution environment. Refer to Instance number and option for command execution environment on page 1-4.</p> <p>-p <port> [hgrp]: Specifies the port ID of the array port to be scanned. Valid ports are CL1-A to CL1-D and CL2-A to CL2-D. This option must always be specified. [hgrp] is specified to display only the LDEVs mapped to a host group on a port for array.</p> <p>-pd[g] <raw_device>: Specifies the raw device name. This option finds Seq# and port_name of the array that the specified device can be connected, and scans the port of the array which corresponds with the unit ID that searches the unit ID from Seq#. This option must always be specified.</p> <p>-pdg option is specified to find host group and to display LUN.</p> <p>-s <Seq#>: Used to specify the Seq# of the array when this option can't specify the unit ID which is contained for "-p <port>" option. This option scans the port specified by "-p <port>" option of the array which corresponds with the unit ID that searches the unit ID from Seq#. If this option is specified, then the unit ID which is contained in "-p <port>" option is invalid.</p> <p>-t <targ>: Specifies a target ID (0 to 15) of the specified port. If this option is not specified, the command applies to all target Ids.</p> <p>-l <lun>: Specifies a LUN (0 to 7) of the specified target ID. If this option is not specified, the command applies to all LUNs. If this option is specified, the TID must also be specified.</p> <p>-fx: Displays the LDEV number in hexadecimal notation.</p> <p>-f or -ff: Specifies display of volume-type for a display column. If this option is specified, then the following -fg and -fd option is invalid.</p> <p>-fg: Specifies display of group_name for a display column. This option searches a group on the configuration definition file (local CCI instance) from the scanned LDEV, and displays a group_name when the scanned LDEV is contained in the group. If this option is specified, the -f[f] option is excluded. If this option is specified, the -fd option is invalid.</p> <p>-fd: Displays the device file registered in HORCM. This option is invalid when the -ff or the -fg option is specified.</p>

Table 1-18: Raidscan Command Parameters (Continued)

Parameter	Value
Options (continued)	<p>-fe: This option displays a device serial number and a volume managing number of the other device to which external LUN is mapped. When no external LUN exists on the specified port, nothing is displayed. Display example:</p> <pre>Port# /ALPA/C TID# LU# Seq# Num LDEV# P/S Status Fence E-Seq# E-LDEV# CL1-A ef 0 0 48 85003005 2 256 SMPL - - 85003006 17 CL1-A ef 0 0 49 85003005 2 272 SMPL - - 85003006 23 CL1-A ef 0 0 50 85003005 1 288 SMPL - - 85003006 28</pre> <p>-CLI: Specifies display for command line interface (CLI). This option displays to the same position that defined number of columns, and displays one header. The delimiters between columns are displayed as spaces or hyphens (-). Display example:</p> <pre>Port# TargetID# Lun# Seq# Num LDEV# P/S Status P-Seq# P-LDEV# CL1-A 1 0 85003005 1 0 SMPL - - - CL1-A 2 2 85003005 1 2 P-VOL PAIR 85003005 26 CL1-A 2 3 85003005 1 3 P-VOL PAIR 85003005 27</pre> <p>-pi<strings>: Used to change the STDIN of the -find option to argument input. If this option is specified, the STDIN becomes invalid. Specify <strings> in less than or equal to 255 characters.</p> <p>-find [op] [MU#]: Executes the operation specified in [op] using a special file (raw device file) provided via STDIN. If the -pi <strings> option is specified, the STDIN becomes invalid and changes to <strings>.</p> <p>Restriction: Special files via STDIN are specified in the following ways: HP-UX systems: /dev/rdisk/*, /dev/rdisk/disk*, /dev/rcdisk/disk* Solaris systems: /dev/rdisk/*s2, c*s2 AIX systems: /dev/rhdisk*, /dev/hdisk*, hdisk* Linux systems: /dev/sd*, /dev/rd*, /dev/raw/raw* Tru64 UNIX systems: /dev/rdisk/dsk*c IRIX systems: /dev/rdisk/*vol, /dev/rdisk/node_wwn/*vol/*, /dev/dsk/*vol, /dev/dsk/node_wwn/*vol/* Windows systems: hd0-10, harddisk0, harddisk1... (numbers indicate the drive number) \$LETALL, \$Volume, \$Phys, D:\Vol(Dms,Dmt, Dmr)\DskY, \Vol(Dms,Dmt, Dmr)\DskY</p> <p>For Windows LDM volumes, refer to the <i>Hitachi AMS 2000 Family Command Control Interface (CCI) User's Guide</i>.</p> <p>-find[g]: Displays the port, target ID, and LUN (array notation) which was mapped for LDEV using a special file (raw device file) provided via STDIN (see Figure 1-39). If target ID and LUN are Unknown for the target device file, you must start HORCM without a description for HORCM_DEV and HORCM_INST, and should describe the shown Port, target ID, and LUN for HORCM_DEV. This option also uses the -fx option to display the LDEV numbers in hexadecimal. -findg option is specified to find host group and to display LUN.</p> <p>-find inst: Obtains the Ser# and LDEV# of the volume using a special file (raw device file) provided via STDIN, and then checks the consistency with the volume described in the configuration definition file. Then registers (permits) the special file name to HORCM, and displays the relation between the configuration definition file. This option is not usually used because it is automatically used by /etc/hormgr. This option also uses the -fx option to display the LDEV numbers in hexadecimal (see Figure 1-40).</p> <p>Note: When activating HORCM, the CCI automatically registers the device file by executing raidscan -find inst command. If this command is executed manually even if the device file has already been registered, a message "The registration has been canceled due to enough for HORCM." Is displayed and the command will be rejected.</p> <p>-find verify [MU#]: Displays the relation between the volumes described in the configuration definition file after obtaining the Ser# and LDEV# of the volume using a special file (raw device file). This option also uses the -fx option to display the LDEV numbers in hexadecimal. This option is effected by the command execution environment (HORCC_MRCF).</p>

Table 1-18: Raidscan Command Parameters (Continued)

Parameter	Value
Options (Continued)	<p>-find[g] conf [MU#] [-g <group>]: Displays the image of the port, target ID, and LUN (array notation) which was mapped for LDEV using a special file (raw device file) provided via STDIN. Before displaying the information, this option edits the information into an image that looks like the configuration definition file. If target ID and LUN are Unknown for the target device file, you must start HORCM without a description for HORCM_DEV and HORCM_INST, and should describe the shown Port, target ID, and LUN for HORCM_DEV. This option also uses the -fx option to display the LDEV numbers in hexadecimal. The -g group option specifies the group name where the name should be described in the configuration definition file. If omitted, "VG" is used for the group name. -findg option is specified to find host group and to display LUN.</p> <p>-find sync [MU#] [-g <group>]: This option reads the search conditions (\$Physical, \$Volume, \$LETALL) from the standard input, searches for a logical drive that corresponds to the group (<group>) defined in the configuration definition file, and then sends the unwritten data on the file system buffer to the logical drive (physical disk) to synchronize the pair (see Figure 1-43). The -g <group> option specifies all the group names on the configuration definition file. If omitted, the -find sync [MU#] searches for a logical drive that corresponds to all groups in the CCI local instance, and sends the unwritten data on the file system buffer to the logical drive (physical disk) to synchronize the pair (see Figure 1-43).</p> <p>Notes: - The sync option executes the following procedures depending on the execution condition. If the logical device that corresponds to the <group> described in the configuration definition file is closed from the application, the sync option flushes the system buffer and changes the logical device to "Dismount" status. If the logical device is opened from the application, the sync option flushes the system buffer only. In this case, [FLUSH] will be displayed. [FLUSH] : ORA ORA_000[-1] -> \Vol44\Dsk0 : Volume{56e4954a-28d5-4824-a408-3ff9a6521e5d}</p> <p>Restriction: - All logical drives that correspond to the group defined in the configuration definition file must be closed from the application. - This option cannot specify the device object name (shown below) for the search conditions: D:\Vol(Dms,Dmt, Dmr)\DskY, \Vol(Dms,Dmt, Dmr)\DskY</p> <p>-m <mun>: Scanning information is displayed only for MU# specified by this option.</p>



NOTE: When SnapShot is installed, the range searched with raidscan is extended to MU#=31 from MU#=0. Therefore, execution of raidscan takes several minutes. When you want to limit the searched range, please use the option that is displayed only for specified host group (**-p <port> [hgrp]**), or the option that is displayed only for specified MU# (**-m <mun>**). And when raidscan is executed, because only LU defined in the searched range is displayed, you may seem that the display is frozen during search of LUs that are not defined.

```
# raidscan -p cl1-a
PORT# /ALPA/C,TID#,LU#.Num(LDEV#....)...P/S, Status,LDEV#,P-Seq#,P-LDEV#
CL1-A / ef/ 5, 1, 0-0.1(0).....P-VOL ---- -, -----
CL1-A / ef/ 5, 1, 1-0.1(1).....SMPL ---- -, -----
```

Figure 1-38: Raidscan Command for Fibre-Channel Ports

```
# echo $Phys | raidscan -find
```

DEVICE_FILE	UID	S/F	PORT	TARG	LUN	SERIAL	LDEV	PRODUCT_ID
Harddisk0	0	F	CL1-A	0	4	85003116	4	DF600F-CM
Harddisk1	0	F	CL1-A	0	2	85003116	2	DF600F
Harddisk2	-	-	CL1-A	-	-	85003117	-	DF600F

Figure 1-39: Raidscan Command -find Option

The output of the raidscan command with the **-find** option includes:

- **UID:** Shows the unit ID for multiple array configurations. If UID is displayed as '-', the command device for HORCM_CMD is not found.
- **S/F:** Shows whether the PORT is SCSI or fibre.
- **PORT:** Shows the array port number.
- **TARG:** Shows the target ID (which was converted by the fibre conversion table).
- **LUN:** Shows the LUN (which was converted by the fibre conversion table).
- **SERIAL:** Shows the production (serial#) number of the array.
- **LDEV:** Shows the LDEV# within the array. LDEV indicates LU.
- **PRODUCT_ID:** Shows the product-id field in the SCSI inquiry page.

```
# echo $Phys | raidscan -find
```

DEVICE_FILE	Group	PairVol	PORT	TARG	LUN	M	SERIAL	LDEV
Harddisk3	oradb	oradev1	CL1-A	3	0	-	85003116	17
Harddisk3	oradb	oradev1	CL1-A	3	0	0	85003116	17

Figure 1-40: Raidscan Command -find inst Option



NOTE: If multiple device files were shared (linked) within the same LDEV, the first one founded would be registered as the device file name.

The output of the raidscan command with **-find inst** option includes:

- **Group:** Shows the group name (dev_group) described in the configuration definition file. If "-" is displayed, the device that corresponds to this group does not exist in the configuration definition file.
- **PairVol:** Shows the dev_name described in the configuration definition file.
- **Port:** Shows the port name described in the configuration definition file.
- **TARG:** Shows the target ID described in the configuration definition file.
- **LUN:** Shows the LU number described in the configuration definition file.
- **M:** Shows the MU# described in the configuration definition file.

- **SERIAL:** Shows the production (serial#) number of the array.
- **LDEV:** Shows the LDEV# within the array. LDEV indicates LU.

```
# echo $Phys | raidscan -find verify
DEVICE_FILE      Group  PairVol  PORT      TARG  LUN M  SERIAL  LDEV
Harddisk0        oradb  oradev1  CL1-A     3     0 0  85003501  17
Harddisk1        oradb  oradev2  CL1-A     3     1 0  85003501  18
Harddisk3        -      -        -         -     - 0  85003501  19

# iocsan -fun | grep rdsd | raidscan -find verify 1 -fd
DEVICE_FILE      Group  PairVol  Device_File  M  SERIAL  LDEV
Harddisk0        oradb  oradev1  C0t3d0      1  85003501  17
Harddisk1        oradb  oradev2  Unknown     1  85003501  18
Harddisk2        -      -        -           1  85003501  19
```

Figure 1-41: Raidscan Command -find conf Option



NOTE: If the contents displayed in `DEVICE_FILE` and `Device_File` is different, it indicates that the volumes are shared (linked) within the same LDEV. If "Unknown" is displayed in `Device_File`, this volume is not registered, so the pair operation (except for local options) is rejected in the protection mode.

The output of the `raidscan` command with `-find verify` option includes:

- **Group:** Shows the group name (`dev_group`) described in the configuration definition file. If "-" is displayed, the device that corresponds to this group does not exist in the configuration definition file.
- **PairVol:** Shows the `dev_name` described in the configuration definition file.
- **Device_File:** Shows the device file registered in HORCM.
- **Port:** Shows the port name described in the configuration definition file.
- **TARG:** Shows the target ID described in the configuration definition file.
- **LUN:** Shows the LU number described in the configuration definition file.
- **M:** Shows the `MU#` described in the configuration definition file.
- **SERIAL:** Shows the production (serial#) number of the array.
- **LDEV:** Shows the LDEV# within the array. LDEV indicates LU.

```
# type hormperm.conf | raidscan -find conf 0 -g ORA
HORCM_DEV
#dev_group      dev_name  port#    TargetID    LU#        MU#
Harddisk14      SER =85006145 LDEV = 2 [FIBRE FCTBL = 4]
ORA             ORA_000   CL2-A    0           0           0
Harddisk15      SER =85006145 LDEV = 3 [FIBRE FCTBL = 4]
ORA             ORA_001   CL2-A    0           1           0
Harddisk16      SER =85006145 LDEV = 4 [FIBRE FCTBL = 4]
ORA             ORA_002   CL2-A    0           2           0
Harddisk17      SER =85006145 LDEV = 5 [FIBRE FCTBL = 4]
ORA             ORA_003   CL2-A    0           3           0
#ERROR [CMDDEV] Harddisk0          SER =85006145 LDEV = 9 [DF600F-CM]
```

Figure 1-42: Raidscan Command -find conf Option



Notes:

- If a command device is included in the STDIN device, a comment is displayed as follows and the target device will not be included.

```
#ERROR [CMDDEV] Harddisk0          SER =85006145 LDEV = 9 [DF600F-CM]
```

- If an STDIN device is shared by multiple device files and is displayed as target device, a comment is displayed as follows and the target device will not be included.

```
#ERROR [LDEV LINK] Harddisk17      SER =85006145 LDEV = 5 [FIBRE FCTBL = 4]
```

- If the STDIN device does not have a proper MU#, a comment is displayed as follows and the target device will not be included.

```
#ERROR [INVALID MUN(2<1)] Harddisk17      SER =85006145 LDEV = 5 [DF600F ]
```

- If the STDIN device is mixed between the arrays that have different mirroring control, a comment is displayed as follows and the target device will not be included.

```
#ERROR [MIXING RAID TYPE] Harddisk17      SER =85006145 LDEV = 5 [DF600F ]
```

The following is an example of synchronizing (flushing) the system buffer that corresponds to group ORB in the configuration definition file.

```
raidscan -pi $Volume -find sync -g ORB
[SYNC] : ORB ORB_000[-] -> \Dmt1\Dsk1 : Volume{bf48a395-0ef6-11d5-8d69-00c00d003b1e}
[SYNC] : ORB ORB_001[-] -> \Dmt1\Dsk2 : Volume{bf48a395-0ef6-11d5-8d69-00c00d003b1e}
[SYNC] : ORB ORB_002[-] -> \Dmt1\Dsk3 : Volume{bf48a395-0ef6-11d5-8d69-00c00d003b1e}
```

Figure 1-43: Raidscan Command -find sync Option Example (1)

The following is an example of synchronizing (flushing) the system buffer that corresponds to all groups in the CCI local instance.

```
[SYNC] : ORA ORA_000[-] -> \Vol14\Dsk0 : Volume{56e4954a-28d5-4824-a408-3ff9a6521e5d}
[SYNC] : ORA ORA_000[-] -> \Vol15\Dsk0 : Volume{56e4954a-28d5-4824-a408-3ff9a6521e5e}
[SYNC] : ORB ORB_000[-] -> \Dmt1\Dsk1 : Volume{bf48a395-0ef6-11d5-8d69-00c00d003b1e}
[SYNC] : ORB ORB_001[-] -> \Dmt1\Dsk2 : Volume{bf48a395-0ef6-11d5-8d69-00c00d003b1e}
[SYNC] : ORB ORB_002[-] -> \Dmt1\Dsk3 : Volume{bf48a395-0ef6-11d5-8d69-00c00d003b1e}
```

Figure 1-44: Raidscan Command -find sync Option Example (2)

Raidar command

The **raidar** command displays configuration, status, and I/O activity information for the specified array port, TIDs, and devices at the specified time interval. The configuration information is acquired directly from the array (not from the configuration definition file). [Table 1-19](#) lists and describes the raidar command parameters. [Figure 1-45](#) shows an example of the raidar command and its output.



NOTE:

- The I/O activity of a ShadowImage or SnapShot S-VOL in the COPY or PAIR state includes only host-requested I/Os. The I/O activity of a P-VOL or simplex volume includes only host-requested I/Os. If state changed into SMPL in S-VOL (COPY, PAIR) I/O actively, and then I/O activity of the between is reported in the SMPL state.
- The array has I/O activity information to be displayed for each controller. Therefore, if you want to display the I/O information using this command, when creating the configuration definition file, you must set the command device that is specified by the controller that accepts the host I/O

Table 1-19: Raidar Command Parameters

Parameter	Value
Command Name	raidar
Format	raidar { -h -q -z -I[H M][instance#] -p <port> <targ> <lun> <mun> -pd[g] <raw_device -s [interval] [count] }
Options	<p>-h: Displays help, usage, and version information.</p> <p>-q: Terminates the interactive mode and exits the command.</p> <p>-z or -zx: Makes the raidar command enter the interactive mode. The -zx option guards performing of the HORCM in the interactive mode. When this option detects a HORCM shut down, interactive mode terminates.</p> <p>-I[H M][instance#] or -I[TC SI][instance#]: Specifies the instance number and the command execution environment. Refer to section Instance number and option for command execution environment on page 1-4.</p> <p>-p <port> <targ> <lun> <mun>.....: Monitors one or more (up to 16) devices at a time.</p> <p> <port>: Specifies the port to be reported: CL1-A to CL1-D and CL2-A to CL2-D. This option must be specified.</p> <p> <targ>: Specifies the SCSI or Fibre target ID (0 to 15) of the specified port.</p> <p> <lun>: Specifies the LUN (0 to 7) on the specified TID.</p> <p> <mun>: Specifies the MU number of the specified LUN.</p> <p>Pd[g] <raw_device>: Allows designation of an LDEV by raw device file name. -pdg option is specified to find host group and to display LUN.</p> <p>-s [interval] or -sm [interval]: Designates the time interval in seconds.</p> <p>-s: Interprets the time interval as seconds.</p> <p>-sm: Interprets the time interval as minutes.</p> <p>[interval]: Designates the time interval value (1 to 60). If the interval is not specified, the default interval (3) is used.</p> <p>[count]: Designates number of repeats. When omitted, this command repeats until Cntl-C.</p>

```

# raidar -p cll-a 15 6 -p cll-b 14 5 -p cll-a 12 3 -s 3
TIME[03] PORT T L VOL STATUS IOPS HIT(%) W(%) IOCNT
13:45:25 - - - - - - - - -
13:45:28 CL1-A 1 6-0 SMPL - 200.0 80.0 40.0 600
          CL1-B 1 5-0 P-VOL PAIR 133.3 35.0 13.4 400
          CL1-A 1 3-0 P-VOL PSUS 200.0 35.0 40.6 600
          CL1-A 1 7-0 *** Can't report activity on this Vol. ***

```

Note: When a device is not mapped to LU, the output status will display "***Can't report activity on this Vol.***". Verify that the device is mapped.

Figure 1-45: Raidar Command Example

The output of the raidar command includes:

- **TIME []:** Shows the interval time.
- **PORT:** Shows the port name of the array.
- **T:** Shows the port ID.
- **L:** Shows the LU number in the target ID of the array.
- **VOL:** Shows the volume attribute (P-VOL, S-VOL, SMPL).
- **STATUS:** Shows the pair status of the paired volume.
- **IOPS:** Shows the number of I/Os (read/write) per second (total I/O rate).
- **HIT(%):** Shows the hit rate for read I/Os (read hit rate).
- **W(%):** Shows the ratio of write I/Os to total I/Os (percent writes).
- **IOCNT:** Shows the number of times of write and read.

Raidqry command

The **raidqry** command (RAID query) displays the configuration of the connected host and array. [Table 1-20](#) lists and describes the raidqry command parameters. [Figure 1-46](#) shows an example of the raidqry command output.

Table 1-20: Raidqry Command Parameters

Parameter	Value
Command Name	raidqry
Format	raidqry { -h -q -z -I[H M][instance#] -l -r <group> [-f] -g }

Table 1-20: Raidqry Command Parameters (Continued)

Options	<p>-h: Displays help, usage, and version information.</p> <p>-q: Terminates the interactive mode and exits the command.</p> <p>-z or -zx: Makes the raidqry command enter the interactive mode. The -zx option guards performing of the HORCM in the interactive mode. When this option detects a HORCM shut down, interactive mode terminates.</p> <p>-I[H M][instance#] or -I[TC SI][instance#]: Specifies the instance number and the command execution environment. Refer to Instance number and option for command execution environment on page 1-4.</p> <p>-l: Displays the configuration information for the local host and the local array.</p> <p>-r <group>: Displays the configuration information for the remote host and the remote array that contains the specified group.</p> <p>-f: Displays the hostname (ip_address) as specified in the configuration definition file. Use this option if “floatable IP address” is used for the hostname (ip_address) in the configuration file.</p> <p>-g: Displays the all group name as specified in the configuration definition file.</p>
---------	---

```
# raidqry -l
No Group      Hostname      HORCM_ver  Uid  Serial#      Micro_ver  Cache(MB)
  1 ---      HOSTA        01-20-03/05  0  85010061    18-30-A0/00  1024

# raidqry -r oradb
No Group      Hostname      HORCM_ver  Uid  Serial#      Micro_ver  Cache(MB)
  1 oradb     HOSTB        01-20-03/05  0  85010062    18-30-A0/00  1024

# raidqry -l -f
No Group      Floatable Host  HORCM_ver  Uid  Serial#      Micro_ver  Cache(MB)
  1 ---      xxx.xxx.xxx.xxx 01-20-03/05  0  85010061    18-30-A0/00  1024

# raidqry -g
Gno  Group      RAID_type  IV/H  IV/M  MUN/H  MUN/M
  1  vg01      HTC_DF     8     6     1     14
```

Figure 1-46: Raidqry Command

The output of the raidqry command includes:

- **No**: Shows the order when the group name (dev_group) described in the configuration definition file has multiple remote hosts.
- **Group**: When the **-r** or **-g** option is used, this column shows the group name (dev_group) described in the configuration definition file.
- **Hostname**: When the **-l** option is used, this column shows the host name of the local host. When the **-r** option is used, this column shows the remote host name for the group (dev_group) which is described in the configuration definition file. The host name with more than or equal to 30 characters cannot be displayed.
- **Floatable Host**: When the **-f** option is used, this column shows the host name (ip_address) described in the configuration definition file. Up to 30 host names can be displayed. The **-f** option interprets the host name as utilizing floatable IP for a host.
- **HORCM_ver**: Shows the version of the HORC Manager on the local or remote host. The **-l** option specifies local host. The **-r** option specifies remote host.

- **Uid Serial# Micro_ver:** Shows the unitID, serial number, and firmware version of the array connected to the local or remote host. The **-l** option specifies local host. The **-r** option specifies remote host.
- **Cache(MB):** Shows the logical cache capacity (in MB) of the array connected to the local or remote host. The **-l** option specifies local host. The **-r** option specifies remote host.
- **Gno:** When the **-g** option is used, this column shows as order when the group name (dev_group) described in the configuration definition file.
- **RAID_type:** When the **-g** option is used, this column shows the type of RAID configured a group.
- **IV/H:** When the **-g** option is used, this column shows the interface version for TrueCopy or TCE that made the consistence in a group, this is used for the maintenance.
- **IV/M:** When the **-g** option is used, this column shows the interface version for ShadowImage or SnapShot that made the consistence in a group, this is used for the maintenance.
- **MUN/H:** When the **-g** option is used, this column shows the number of maximum MUs for TrueCopy or TCE that made the consistence in a group.
- **MUN/M:** When the **-g** option is used, this column shows the number of maximum MUs for ShadowImage or SnapShot that made the consistence in a group.

Data protection

The AMS array supports parameters for data protection of each LU, and these parameters are set through the command device using CCI. CCI supports the following three commands in order to set and verify these parameters for data protection of each LU.

- **raidvchkset:** Sets the parameter for data protection to the specified volumes.
- **raidvchkdsp:** Shows the parameter for data protection on the specified volumes based on CCI configuration definition file.
- **raidvchkscan:** Shows the parameter for data protection on the specified ports based on the raidscan command.

Raidvchkset command

The raidvchkset command sets the parameters for data protection of the specified volumes, and can also be used to turn off all data protection without specifying [type]. Unit of protection for data is based on the group of CCI configuration definition file. [Table 1-21](#) lists and describes the raidvchkset command parameters.

Table 1-21: Raidvchkset Command Parameters

Parameter	Value
Command Name	raidvchkset
Format	raidvchkset { -h -q -z -I[H M][instance#] -g <group> -d <pair Vol> -d[g] <raw_device> [MU#] -d[g] <seq#> <LDEV#> [MU#] -nomsg -vg [type][rtime] }
Options	<p>-h: Displays help, usage, and version information.</p> <p>-q: Terminates the interactive mode and exits the command.</p> <p>-z or -zx: Makes the raidvchkset command enter the interactive mode. The -zx option guards performing of the HORCM in the interactive mode. When this option detects a HORCM shut down, interactive mode terminates.</p> <p>-I[H M][instance#] or -I[TC SI][instance#]: Specifies the instance number and the command execution environment. Refer to Instance number and option for command execution environment on page 1-4.</p> <p>-g <group>: Specifies a group name written in the configuration definition file.</p> <p>-d <pair Vol>: Specifies paired logical volume name defined in the configuration definition file. When this option is specified, the command is executed for the specified paired logical volume.</p> <p>-d[g] <raw_device> [MU#]: Searches a group on the configuration definition file (local instance) for the specified raw_device, and if the specified raw_device is contained in the group, the target volume is executed as the paired logical volume (-d) or group (-dg). This option is effective without specification of "-g <group>" option. If the specified the raw_device is contained in two or more groups, the command is executed on the first group.</p> <p>-d[g] <seq#> <LDEV#> [MU#]: Searches a group on the configuration definition file (local instance) for the specified LDEV, and if the specified LDEV is in the group, the target volume is executed as the paired logical volume (-d) or group (-dg). This option is effective without specification of "-g <group>" option. If the specified LDEV is contained in two or more groups, the command is executed on the first group. The <seq #> <LDEV #> values can be specified in hexadecimal (by addition of "0x ") or decimal notation.</p> <p>-nomsg: Specifies the following data type that assumes the target volumes as data protection. If [type] is not specified, then this option will disable all of the protection.</p> <p>Note: When you specify inv, sz0, rwd, or wtd as the -vg option, specify svd.</p> <p>Inv: The object volume is prohibited from reading or writing, the size zero in reply to the Read Capacity command, and is hidden from the Inquiry command.</p> <p>Sz0: The object volume is prohibited from reading or writing, and the size zero in reply to the Read Capacity command.</p> <p>Rwd: It is prohibited to read from or write to the object volume.</p> <p>Wtd: It is prohibited to write from or to the object volume.</p> <p>Svd: It is inhibited to assign the object volume in the SMPL status to an S-VOL.</p> <p>Idb: The object volume is hidden from the Inquiry command only.</p> <p>[rtime]: Specifies the retention time, in units of day. If [rtime] is not specified, the default time defined by the AMS array will be used. The default time is "zero". When specifying "infinite", specify it as "--".</p>
Returned values	<p>Normal termination: 0.</p> <p>Abnormal termination: Returns a common error code and a unique error code for this command. For details on error codes, see Chapter 2, Troubleshooting.</p>

```
# raidvchkset -g vg01 -d oradb1 -vg wtd svd 365
```

Figure 1-47: Raidvchkset Command Examples with -vg Options

Volume restrictions

When the volume concerned has been set as a protected volume using the `raidvchkset` command, the following restrictions are placed upon it:

- The setting with the `raidvchkset -vg svd` or `raidvchkset -vg idb` can be performed without using the license key for Data Retention, however, the setting cannot be released by Navigator 2. In regard to an LU for which the setting has been made using the `raidvchkset -vg svd` or `raidvchkset -vg idb`, operations such as deleting and formatting of it are restricted. To release the setting, issue the `raidvchkset -vg` command.
- When setting the data protection for a UNIX file system volume, make the volume concerned unmounted, and then mount it as a read-only volume to use it.
For a Windows Server file system, you have to use "`-x mount`" and "`-x umount`" option of CCI commands with above procedures.
For a Windows 2000 file system volume, a read-only volume is not recognized correctly.
- When changing a configuration of the LVM including a protected volume, the volume concerned must be temporarily placed in the status in which the check on it is inhibited by the `raidvchkset -vg` command. Place the volume again in the status in which it is checked when the LVM configuration change is completed.
- There may be a case where a volume to which the data protection is applied cannot be used as a resource of the HA cluster software (such as the MSCS). This is because the HA cluster software (such as the MSCS) writes management information in the management area periodically in order to check propriety of the resource.
- When setting a volume being used by Windows 2000 or Windows Server as a protected volume, the protection can be applied to a basic disk only. When the protection is applied to a dynamic disk, the volume is not recognized correctly.
- Some OS cannot be recognized LUNs over LUN#1, if LUN#0 will be set to the "inv" as the attribute of the data protection, the reason is that some HBA driver does not scan all LUNs on a port, if LUN#0 will be invisible.

Raidvchkdsp command

The `raidvchkdsp` command displays the parameters for data protection of the specified volumes. Unit of protection for the data is based on the group of CCI configuration definition file. [Table 1-22](#) lists and describes the `raidvchkdsp` command parameters. [Figure 1-48](#) through [Figure 1-50](#) show examples of the `raidvchkdsp` command.

Table 1-22: Raidvchkdsp Command Parameters

Parameter	Value
Command Name	raidvchkdsp
Format	raidvchkdsp { -h -q -z -I[H M][instance#] -g <group> -d <pair Vol> -d[g] <raw_device> [MU#] -d[g] <seq#> <LDEV#> [MU#] [-f[xd]] [-v gflag] [-v pool] -c }
Options	<p>-h: Displays help, usage, and version information.</p> <p>-q: Terminates the interactive mode and exits the command.</p> <p>-z or -zx: Makes the raidvchkdsp command enter the interactive mode. The -zx option guards performing of the HORCM in the interactive mode. When this option detects a HORCM shut down, interactive mode terminates.</p> <p>-I[H M][instance#] or -I[TC SI][instance#]: Specifies the instance number and the command execution environment. Refer to Instance number and option for command execution environment on page 1-4.</p> <p>-g <group>: Specifies a group name written in the configuration definition file.</p> <p>-d <pair Vol>: Specifies paired logical volume name defined in the configuration definition file. When this option is specified, the command is executed for the specified paired logical volume.</p> <p>-d[g] <raw_device> [MU#]: Searches a group on the configuration definition file (local instance) for the specified raw_device, and if the specified raw_device is contained in the group, the target volume is executed as the paired logical volume (-d) or group (-dg). This option is effective without specification of "-g <group>" option. If the specified the raw_device is contained in two or more groups, the command is executed on the first group.</p> <p>-d[g] <seq#> <LDEV#> [MU#]: Searches a group on the configuration definition file (local instance) for the specified LDEV, and if the specified LDEV is in the group, the target volume is executed as the paired logical volume (-d) or group (-dg). This option is effective without specification of "-g <group>" option. If the specified LDEV is contained in two or more groups, the command is executed on the first group. The <seq #> <LDEV #> values can be specified in hexadecimal (by addition of "0x ") or decimal notation.</p> <p>-fx: Displays the LDEV number in hexadecimal.</p> <p>-fd: Displays the relation between the Device_File and the paired Volumes, based on the Group (as defined in the local instance configuration definition file). If Device_File column shows "Unknown" to HOST (instance) (Figure 1-48), then the volume is not recognized on own HOST, and raidvchkdsp command will be rejected in protection mode. Non-permitted volume is shown without LDEV# information (LDEV# is " - ").</p> <p>-v [op]: Specifies the following operation that displays each parameter for data protection:</p> <ul style="list-style-type: none"> gflag: Displays all flags for protection regarding data block protection for target vols (see Figure 1-48). pool: This option shows the usage of the pool (see Figure 1-49). <p>-c: When this option is specified, the command checks whether the relation between the connecting path of the volume described in the configuration definition file and the LU was changed or not and displays only the configurations changed illegally.</p>
Returned values	<p>Normal termination: 0.</p> <p>Abnormal termination: Returns a common error code and a unique error code for this command. For details on error codes, see Chapter 2, Troubleshooting.</p>

```
# raidvchkdsp -g vg01 -fd -v gflag ← Example of -v gflag option.
Group  PairVol Device_File      Seq# LDEV# GI-C-R-W-S  PI-C-R-W-S  R-Time
vg01   oradb1  Unknown      85000067   3  D D D D D  E E E D D    365
vg01   oradb2  Unknown      85000067   4  E E E E E  E E E E E     -
```

Figure 1-48: Raidvchkdsp Command Examples with -fd and -v gflag Options

The output of the raidvchkdsp command with **-v gflag** option includes:

- **Group:** Shows the group name (dev_group) described in the configuration definition file.
- **Pair Vol:** Shows the paired volume name (dev_name) described in the configuration definition file.
- **Device_File:** Shows the device file registered in HORCM.
- **Seq#:** Shows the serial number of the AMS array.
- **LDEV#:** Shows the logical device number. LDEV indicates LU.
- **GI-C-R-W-S:** This displays the flags for guarding as for the target volume.
 - I=E: The volume is permitted to accept the Inquiry command.
 - I=D: The volume is not permitted to accept the Inquiry command.
 - C=E: The volume returns the formal volume size in reply.
 - C=D: The volume returns the size zero in reply.
 - R=E: It is permitted to read from or to the object volume.
 - R=D: It is prohibited to read from or to the object volume.
 - W=E: It is permitted to write from or to the object volume.
 - W=D: It is prohibited to write from or to the object volume.
 - S=E: The volume can be assigned to an S-VOL.
 - S=D: The volume cannot be assigned to an S-VOL.
- **PI-C-R-W-S:** This displays the permission flags that shows whether each mode flags can be changed to enable or not.
 - I=E: This shows that "I" flag can be changed to enable.
 - I=D: This shows that "I" flag cannot be changed to enable.
 - C=E: This shows that "C" flag can be changed to enable.
 - C=D: This shows that "C" flag cannot be changed to enable.
 - R=E: This shows that "R" flag can be changed to enable.
 - R=D: This shows that "R" flag cannot be changed to enable.
 - W=E: This shows that "W" flag can be changed to enable.
 - W=D: This shows that "W" flag cannot be changed to enable.
 - S=E: This shows that "S" flag can be changed to enable.
 - S=D: This shows that "S" flag cannot be changed to enable.
- **R-Time:** The term of protection set for the LU is displayed with a number of days. When "-" is displayed, it means that the term is indefinite. Expiration Lock status is shown as the retention time plus 1000000. "R-Time + 1000000" shows the retention time with Expiration Lock status.

```
# raidvchkdsp -g vg01 -d oradb1 -v pool ← Example of -v pool option.
Group  PairVol  Port#  TID  LU  Seq#  LDEV#  Bsize  Available  Capacity
vg01   oradb1  CL1-A  1    2   8500015  2     2048     1024     3072
```

Figure 1-49: Raidvchkdsp Command Examples with -v pool Options

The output of the raidvchkdsp command with **-v pool** option includes:

- **Group:** Shows the group name (dev_group) described in the configuration definition file.
- **Pair Vol:** Shows the paired volume name (dev_name) described in the configuration definition file.
- **Port#:** Shows the device file registered in HORCM.
- **TID:** Shows the target ID.
- **LU:** Shows the LU number in the target ID of the AMS array.
- **Seq#:** Shows the serial number of the AMS array.
- **LDEV#:** Shows the logical device number. LDEV indicates LU.
- **Bsize:** The unit of Available and Capacity is shown by block (1 block = 512 bytes). The unit of Available and Capacity becomes 1 MB (= 2,048 blocks) in the example of a display in [Figure 1-49](#).
- **Available:** Shows the available capacity for the volume data on the pool.
- **Capacity:** Shows the total capacity in the pool.

```
# raidvchkdsp -g vg01 -c
Group  PairVol  Port#  TID  LU  Seq#  LDEV#  LDEV#(conf)  -change->  LDEV#
vg01   oradb1  CL1-A  1    2   8500015  -      2(conf)  -change->  NO LDEV
```

Figure 1-50: Raidvchkdsp Command Examples with -c Options

The output of the raidvchkdsp command with **-c** option includes:

- **Group:** Shows the group name (dev_group) described in the configuration definition file.
- **Pair Vol:** Shows the paired volume name (dev_name) described in the configuration definition file.
- **Port#:** Shows the device file registered in HORCM.
- **TID:** Shows the target ID.
- **LU:** Shows the LU number in the target ID of the AMS array.
- **Seq#:** Shows the serial number of the AMS array.
- **LDEV#:** Shows the logical device number. LDEV indicates LU.
- **LDEV#(conf):** Shows the LU number that was described in the configuration definition file at the time of the instance start.

Raidvchkscan command

The raidvchkscan command displays the fibre port of the AMS array, target ID, LDEV mapped for LUN# and the parameters for data protection, regardless of the configuration definition file. [Table 1-23](#) lists and describes the raidvchkscan command parameters. [Figure 1-51](#) and [Figure 1-52](#) show examples of the raidvchkscan command.

Table 1-23: Raidvchkscan Command Parameters

Parameter	Value
Command Name	raidvchkscan
Format	raidvchkscan { -h -q -z -I[H M][instance#] -p <port> [hgrp] -pd[g] <raw_device> -s <seq#> -t <target> -l <lun> [-f[x]] [-v gflag] [-v pid]}
Options	<p>-h: Displays help, usage, and version information.</p> <p>-q: Terminates the interactive mode and exits the command.</p> <p>-z or -zx: Makes the raidvchkscan command enter the interactive mode. The -zx option guards performing of the HORCM in the interactive mode. When this option detects a HORCM shut down, interactive mode terminates.</p> <p>-I[H M][instance#] or -I[TC SI][instance#]: Specifies the instance number and the command execution environment. Refer to Instance number and option for command execution environment on page 1-4.</p> <p>-p <port> [hgrp]: Specifies the port ID of the AMS array port to be scanned. Valid ports are CL1-A to CL1-D and CL2-A to CL2-D. This option must always be specified. [hgrp] is specified to display only the LDEVs mapped to a host group on a port for AMS array.</p> <p>-pd[g] <raw_device>: Specifies the raw device name. This option finds Seq# and port_name of the AMS array that the specified device can be connected, and scans the port of the AMS array which corresponds with the unit ID that searches the unit ID from Seq#. This option must always be specified.</p> <p>-pdg option is specified to find host group and to display LUN.</p> <p>-s <Seq#>: Used to specify the Seq# of the AMS array when this option can't specify the unit ID which is contained for "-p <port>" option. This option scans the port specified by "-p <port>" option of the AMS array which corresponds with the unit ID that searches the unit ID from Seq#. If this option is specified, then the unit ID which is contained in "-p <port>" option is invalid.</p> <p>-t <targ>: Specifies a target ID (0 to 15) of the specified port. If this option is not specified, the command applies to all target IDs.</p> <p>-l <lun>: Specifies a LUN (0 to 7) of the specified target ID. If this option is not specified, the command applies to all LUNs. If this option is specified, the TID must also be specified.</p> <p>-fx: Displays the LDEV number in hexadecimal notation.</p> <p>-v [op]: Specifies the following operation that displays each parameter for data protection:</p> <ul style="list-style-type: none"> gflag: Displays all flags for protection regarding data block protection for target vols (see Figure 1-51). pid: This option shows the usage of the pool. The displayed contents are the same as the pairedisplay -v pid.
Returned values	<p>Normal termination: 0.</p> <p>Abnormal termination: Returns a common error code and a unique error code for this command. For details on error codes, see Chapter 2, Troubleshooting.</p>

PORT#	/ALPA/C	TID#	LU#	Seq#	Num	LDEV#	GI-C-R-W-S	PI-C-R-W-S	R-Time
CL1-A	/ef/	0	0	2	85002332	1	2 D D D D D	E E E D D	365
CL1-A	/ef/	0	0	3	85002332	1	3 E E E E E	E E E E E	-

Figure 1-51: Raidvchkscan Command Examples with -v gflag Options

The output of the raidvchkscan command with **-v gflag** option includes:

- **Port#:** Shows the port name of the AMS array.
- **ALPA/C:** For the fibre channel, shows the physical address of the Fibre channel in a port.
- **TID#:** Shows the target ID of the AMS array.
- **LU#:** Shows the LU number.
- **Seq#:** Shows the production (serial#) number of the AMS array.
- **Num:** Shows the number of the volumes which constitute LU# (one fixed).
- **LDEV#:** Shows the LDEV# within the AMS array. LDEV indicates LU.
- **GI-C-R-W-S:** This displays the flags for guarding as for the target volume.
 - I=E: The volume is permitted to accept the Inquiry command.
 - I=D: The volume is not permitted to accept the Inquiry command.
 - C=E: The volume returns the formal volume size in reply.
 - C=D: The volume returns the size zero in reply.
 - R=E: It is permitted to read from or to the object volume.
 - R=D: It is prohibited to read from or to the object volume.
 - W=E: It is permitted to write from or to the object volume.
 - W=D: It is prohibited to write from or to the object volume.
 - S=E: The volume can be assigned to an S-VOL.
 - S=D: The volume cannot be assigned to an S-VOL.
- **PI-C-R-W-S:** This displays the permission flags that shows whether each mode flags can be changed to enable or not.
 - I=E: This shows that "I" flag can be changed to enable.
 - I=D: This shows that "I" flag cannot be changed to enable.
 - C=E: This shows that "C" flag can be changed to enable.
 - C=D: This shows that "C" flag cannot be changed to enable.
 - R=E: This shows that "R" flag can be changed to enable.
 - R=D: This shows that "R" flag cannot be changed to enable.
 - W=E: This shows that "W" flag can be changed to enable.
 - W=D: This shows that "W" flag cannot be changed to enable.
 - S=E: This shows that "S" flag can be changed to enable.
 - S=D: This shows that "S" flag cannot be changed to enable.
- **R-Time:** The term of protection set for the LU is displayed with a number of days. When "-" is displayed, it means that the term is indefinite. Expiration Lock status is shown as the retention time plus 1000000. "R-Time + 1000000" shows the retention time with Expiration Lock status.

Figure 1-52 shows examples of the **-v pool** option of the pairdisplay command.

```
# raidvchkscan -p CL1-A -v pool
PORT# /ALPA/C TID# LU# Seq# Num LDEV# Bsize Available Capacity
CL1-A /ef/ 5 1 0 85000052 1 0 2048 0 0
CL1-A /ef/ 5 1 1 85000052 1 1 2048 0 0
CL1-A /ef/ 5 1 2 85000052 1 2 2048 0 0
CL1-A /ef/ 5 1 3 85000052 1 3 2048 5120 5120
CL1-A /ef/ 5 1 4 85000052 1 4 2048 0 0
CL1-A /ef/ 5 1 5 85000052 1 5 2048 5120 5120
```

Figure 1-52: Raidvchkscan Command Examples with -v pool Options

The output of the pairdisplay command with **-v pool** includes:

- **Bsize:** The unit of Available and Capacity is shown by block (1 block = 512 bytes). The unit of Available and Capacity becomes 1 MB (= 2,048 blocks) in the example of a display in Figure 1-52.
- **Available:** The remaining capacity of the pool that the pair configured by the volume uses is shown.
- **Capacity:** All capacity of the pool that the pair configured by the volume uses is shown.

Controlling CCI activity

Horcmstart command

The horcmstart command is a shell script that starts the HORCM application (/etc/horcmgr). This shell script also sets the environment variables for HORCM as needed (that is, HORCM_CONF, HORCM_LOG, HORCM_LOGS). Table 1-24 lists and describes the horcmstart command parameters.

Table 1-24: Horcmstart Command Parameters

Parameter	Value
Command Name	horcmstart
Format	horcmstart.sh { inst ... } horcmstart.exe { inst ... }
Options	Inst: Specifies the HORCM instance number (numerical value). When this option is specified, the horcmstart shell script sets the environment variables (HORCMINST, HORCM_CONF, HORCM_LOG, HORCM_LOGS) that correspond to the instance number, and starts the specified HORCM instance. (Environment variables set by you become invalid.) When this option is not specified, the horcmstart shell script starts 1 HORCM and uses the environment variables set by you. If you have designated full environment variables, you should use horcmstart.sh without any arguments. If you did not designate environment variables (HORCM_CONF, HORCM_LOG, HORCM_LOGS), then this shell script sets the environment variables as follows: For UNIX-based platforms:

Table 1-24: Horcmstart Command Parameters (Continued)

Parameter	Value
Options (continued)	<p>If HORCMINST is specified: HORCM_CONF = /etc/horcm*.conf (* is instance number) HORCM_LOG = /HORCM/log*/curlog HORCM_LOGS = /HORCM/log*/tmplog If no HORCMINST is specified: HORCM_CONF = /etc/horcm.conf HORCM_LOG = /HORCM/log/curlog HORCM_LOGS = /HORCM/log/tmplog For Windows 2000 platform: If HORCMINST is specified: HORCM_CONF = \WINNT\horcm*.conf (* is instance number) HORCM_LOG = \HORCM\log*\curlog HORCM_LOGS = \HORCM\log*\tmplog If no HORCMINST is specified: HORCM_CONF = \WINNT\horcm.conf HORCM_LOG = \HORCM\log\curlog HORCM_LOGS = \HORCM\log\tmplog For Windows Server platform: If HORCMINST is specified: HORCM_CONF = \WINDOWS\horcm*.conf (* is instance number) HORCM_LOG = \HORCM\log*\curlog HORCM_LOGS = \HORCM\log*\tmplog If no HORCMINST is specified: HORCM_CONF = \WINDOWS\horcm.conf HORCM_LOG = \HORCM\log\curlog HORCM_LOGS = \HORCM\log\tmplog</p> <p>Note 1: The HORCM_LOGS environment variable is used to specify the log file directory for automatic storing. When HORCM starts up, the log files created in the operation are stored automatically in the HORCM_LOGS directory. This log directory must give an equality class with HORCM_LOG.</p> <p>Note 2: The HORCMSTART_WAIT environment variable waits until HORCM becomes ready for use. However, this time may take longer than usual depending the operating system, HBA driver, or command device. As a result, a time-out may occur exceeding this waiting time and the start may fail (the process exists in the status where HORCM is starting). In such a case, start HORCM setting the wait time for the variable. The waiting time must be specified more than 5 seconds in multiples of 5 seconds.</p>



NOTE: When this command is started in the status where a file under the HORCM_LOG and HORCM_LOGS directory is opened in the case of Windows 2000 or Windows Server, the operation will terminate abnormally. In this case, take actions as shown below since a message, which informs that the file cannot be deleted or moved, is output.

- When a file under the HORCM_LOG and HORCM_LOGS directory is opened, close the file, and then start the command.
- Investigate whether the program, which traces the directories and the files in the drive, is operating in the background as a service (such as CL and DTC service). If it is possible that the program collides with the service, start the program by adjusting the time.

Horcmshutdown command

The **horcmshutdown** command is a shell script for stopping the HORCM application (/etc/horcmgr). [Table 1-25](#) describes the shutdown command parameters.

Table 1-25: Horcmshutdown Command Parameters

Parameter	Value
Command Name	horcmshutdown
Format	horcmshutdown.sh {inst...} horcmshutdown.exe {inst...}
Option	Inst: Specifies the HORCM (CCI) instance number (numerical value). When this option is specified, the command stops the specified HORCM instance. When this option is not specified, the command refers to the instance (environment variable HORCMINST) of the execution environment of this shell script and stops the following the HORCM instance. When HORCMINST is specified, this command stops the HORCM instance of the execution environment of this shell script. When HORCMINST is not specified, this command stops the HORCM having no instance setting. Note: This command instructs the HORCM instance to stop and receives a response immediately before the HORCM instance stops. Therefore, the response to this command does not mean that the HORCM instance has disappeared.

Horcctl command

The HORCM software has logs that identify the cause of software and hardware errors as well as a tracing function for investigating such errors. The location of the log files depends on you's command execution environment and the HORC Manager's execution environment. The command trace file and core file reside together under the directory specified in the HORC Manager's execution environment. See [Chapter 3, Maintenance log and tracing functions](#) for log file and log directory information.

The **horcctl** command can be used for both maintenance and [Chapter 2, Troubleshooting](#). The horcctl command allows you to change and display the internal trace control parameters (that is, level, type, buffer size) of the HORC Manager commands. If a new value for a parameter is not specified, the current trace control parameter is displayed. [Table 1-26](#) lists and describes the horcctl command parameters.



CAUTION! Do not change the trace level unless directed to do so by a Hitachi representative. Level 4 is the normal trace level setting. Levels 0-3 are for [Chapter 2, Troubleshooting](#). Setting a trace level other than 4 may impact problem resolution. If you request a change of the trace level using the horcctl -l <level> command, a warning message is displayed, and this command enters interactive mode.

Table 1-26: Horcctl Command Parameters

Parameter	Value
Command Name	horcctl
Format	horcctl { -h -q -z -I[H M][instance#] -d -c -l <level> -d <y/n> -s <size(KB)> -t <type> -S -D -C [-u <-unitid> -ND -NC -g <group>}
Options	<p>-h: Displays help, usage, and version information.</p> <p>-q: Terminates the interactive mode and exits the command.</p> <p>-z or -zx: Makes the horcctl command enter the interactive mode. The -zx option guards performing of the HORCM in the interactive mode. When this option detects a HORCM shut down, interactive mode terminates.</p> <p>-I[H M][instance#] or -I[TC SI][instance#]: Specifies the instance number and the command execution environment. Refer to Instance number and option for command execution environment on page 1-4.</p> <p>-d: Interprets the control options following this option (-l <level>, -b <y/n>, -s <size(kB)>, and -t <type>) as the parameters of the CCI commands.</p> <p>-c: Interprets the control options following this option (-l <level>, -b <y/n> and -t <type>) as the parameters of the HORC Manager (HORCM).</p> <p>-l <level>: Sets the trace level (range = 0 to 15). If a negative value is specified, the trace mode is canceled. A negative value "n" must be specified as "-n". Caution: Do not change the trace level unless directed to do so by a Hitachi representative. Level 4 is the normal trace level setting. Levels 0-3 are for Chapter 2, Troubleshooting. Setting a trace level other than 4 may impact problem resolution. If you request a change of the trace level using the horcctl -l <level> command, a warning message is displayed, and this command enters interactive mode.</p> <p>-b <y/n>: Sets the trace writing mode: Y = buffer mode, N = synchronous mode.</p> <p>-t <type>: Sets the trace type (range = 0 to 511). When this option is used, only traces of the specified type are output. One or more values can be specified.</p> <p>-s <size(KB)>: Changes the default trace buffer size, which is 1 MB, in units of 1,024 bytes.</p> <p>-S: Shuts down HORCM.</p> <p>-D: Displays the command device name currently used by HORCM. If the command device is blocked due to online maintenance (firmware replacement) of the array, you can check the command device name in advance using this option.</p> <p>-C: Changes the command device name being used by HORCM and displays the new command device name. If the command device is blocked due to online maintenance of the array, you can change the command device in advance using this option.</p> <p>-u <unitid>: Used to specify the unit ID of a command device as the target. This option is effective when the -D or -C option is specified. If this option is not specified, the unit ID is 0.</p> <p>-ND -g <group>: Displays the network address and port name being used by HORCM. The -g <group> option is used to specify the group name defined in the configuration definition file.</p> <p>-NC -g <group>: Changes the network address and port name being used by HORCM and displays the new network address name. The -g <group> option specifies the group name defined in the configuration definition file.</p>

The following is an example of changing the trace level to 15.

```
C:\HORCM\etc>horcctl -d -l 15
/***** WARNING
*****/
/*   This is an option for maintenance, and used for troubleshooting.   */
/*   When it is issued, the internal trace control parameters of the HRC  */
/*   manager and HRC commands are changed and displayed.                 */
/*   These trace control parameters should not be changed unless directed  */
/*   by a CS&S service representative.                                     */
/*   For cancel   -> Enter '-q' option                                   */
/*   For continue -> Re-enter '-c ...' or '-d ...' options              */
/***** WARNING
*****/
horcctl[HOMRCF]: -q
C:\HORCM\etc>
```

Figure 1-53: Horcctl command -d -l Option

```
C:\HORCM\etc>horcctl -d
logdir = C:\HORCM\log1\curlog
[Client]:
trace = ON
level = 4
mode = Buffer
size = 1024 KB
type = 0, 1, 2, 3, 4, 5, 6, 7, 8, 9,10,11,12,13,14,15,16,17,18,19...Full
```

Figure 1-54: Horcctl command -d Option

```
C:\HORCM\etc>horcctl -c
logdir = C:\HORCM\log1\curlog
[HORCM]:
trace = ON
level = 4
mode = Buffer
size = 1024 KB
type = 0, 1, 2, 3, 4, 5, 6, 7, 8, 9,10,11,12,13,14,15,16,17,18,19...Full
```

Figure 1-55: Horcctl command -c Option

Windows 2000 and Windows Server subcommands

The CCI software provides subcommands for the Windows 2000 and Windows Server platforms that are executed as options (-x <command> <arg>) of another command. When you specify a subcommand as the only option of a command, you do not need to start HORCM. If another option of the command and the subcommand is specified on the same command line, place the other option after the subcommand.

Findcmddev subcommand

The **findcmddev** subcommand (find command device) searches for command devices within the specified range of disk drive numbers. If it is found, the command device is displayed in the same format as in the configuration definition file. This subcommand is used when the command device name is not known. Table 1-27 lists and describes the findcmddev subcommand parameters. Figure 1-56 shows an example of the findcmddev subcommand used as an option of the raidscan command output.



CAUTION! The findcmddev subcommand must be used when HORCM is not running.



NOTE: The findcmddev subcommand searches for the physical and logical devices associated with the command device. If the command device is indicated as a logical device, you must delete the drive letter assigned to the command device to prevent utilization by general users. The physical drive number may change at every reboot. If the number changes, use \\.\CMD-Ser#-ldev#-Port# or Volume{guid} for which the same name is kept. Volume{guid} is created when you make a partition by using the Windows' Disk Management. Do not format.

Table 1-27: Findcmddev Subcommand Parameters

Parameter	Value
Command Name	findcmddev
Format	-x findcmddev drive#(0-N)
Argument	drive#(0-N): Specifies the range of disk drive numbers on the Windows 2000 or Windows Server systems.

The following searches for command devices in the range of disk drive numbers 0 to 20.

```
C:\HORCM\etc>raidscan -x findcmddev hdisk0,20
cmddev of Ser#85003001 = \\.\PhysicalDrive0
cmddev of Ser#85003001 = \\.\E:
cmddev of Ser#85003001 = \\.\Volume{b9b31c79-240a-11d5-a37f-00c00d003b1e}
```

Figure 1-56: Findcmddev Subcommand

Drivescan subcommand

The drivescan subcommand displays the relationship between the disk numbers assigned by the Windows 2000 or Windows Server system and the LDEVs on the array, and also displays attribute and status information for each LDEV. [Table 1-28](#) lists and describes the drivescan subcommand parameters. [Figure 1-57](#) shows an example of the drivescan subcommand used as an option of the raidscan command and its output.8

Table 1-28: Drivescan Subcommand Parameters

Parameter	Value
Command Name	drivescan
Format	-x drivescan drive#(0-N)
Argument	drive#(0-N) : Specifies the range of disk drive numbers on the Windows system.

The following displays the devices for the range of disk drive numbers from 0 to 20.

```
C:\HORCM\etc>raidscan -x drivescan harddisk0,20
Harddisk 0... Port[ 1] PhId[ 0] TId[ 0] Lun[ 0] [HITACHI] [DK328H-43WS ]
Harddisk 1... Port[ 2] PhId[ 4] TId[ 29] Lun[ 0] [HITACHI] [DF600F ]
                Port[CL1-A] Ser#[85003005] LDEV#[ 9(0x009)]
                HORC = SMPL HOMRCF[MU#0 = SMPL MU#1 = NONE MU#2 = NONE]
                RAID5[Group 2- 1] SSID = 0x0000
Harddisk 2... Port[ 2] PhId[ 4] TId[ 29] Lun[ 1] [HITACHI] [DF600F ]
                Port[CL1-A] Ser#[85003005] LDEV#[ 10(0x00A)]
                HORC = SMPL HOMRCF[MU#0 = SMPL MU#1 = NONE MU#2 = NONE]
                RAID5[Group 2- 1] SSID = 0x0000
Harddisk 3... Port[ 2] PhId[ 4] TId[ 29] Lun[ 6] [HITACHI] [DF600F-CM ]
                Port[CL1-A] Ser#[85003005] LDEV#[ 15(0x00F)]
```

Figure 1-57: Drivescan Subcommand Example

The output of the drivescan subcommand includes:

- **Harddisk #**: Shows the hard disk recognized by the Windows 2000 or Windows Server system.
- **Port**: Shows the port number on the device adapter recognized by the Windows 2000 or Windows Server system.
- **PhId**: Shows the bus number on the device adapter port recognized by the Windows 2000 or Windows Server 2003 system.
- **Tid**: Shows the target ID of the hard disks on the specified port and bus.
- **LUN**: Shows the LU number of the hard disk on the specified port, bus, and TID.
- **Port[CLX-Y]**: Shows the port number on the array.
- **Ser#**: Shows the production number of the array.

- **LDEV#:** Shows the LDEV ID (hexadecimal) of the specified volume on the array. LDEV indicates LU.
- **HORC:** Shows the TrueCopy or TCE attribute (P-VOL, S-VOL, SMPL).
- **HOMRCF:** Shows the ShadowImage or SnapShot attribute (P-VOL, S-VOL, SMPL) and MU number of the specified volume.
- **RAIDX[Group]:** Shows the physical location (frame number-parity group number) of the specified volume and the RAID level of this parity group.
- **SSID:** Shows the SSID of the specified volume.

Portscan subcommand

The **portscan** subcommand displays the devices on the specified ports. [Table 1-29](#) lists and describes the portscan subcommand parameters. [Figure 1-58](#) shows an example of the portscan subcommand used as an option of the raidscan command and its output.

Table 1-29: Portscan Subcommand Parameters

Parameter	Value
Command Name	portscan
Format	-x portscan port#(0-N)
Argument	port#(0-N): Specifies the range of port numbers on the Windows 2000 or Windows Server 2003 system.

The following displays the devices for the range of ports from 0 to 20.

```
C:\HORCM\etc>raidscan -x portscan port0,20
PORT[ 0] IID [ 7] SCSI Devices
      PhId[ 0] TId[ 3] Lun[ 0] [MATSHIT] [CD-ROM CR-508 ] ...Claimed
      PhId[ 0] TId[ 4] Lun[ 0] [HP      ] [C1537A      ] ...Claimed
PORT[ 1] IID [ 7] SCSI Devices
      PhId[ 0] TId[ 0] Lun[ 0] [HITACHI ] [DK328H-43WS ] ...Claimed
PORT[ 2] IID [ 7] SCSI Devices
      PhId[ 0] TId[ 5] Lun[ 0] [HITACHI ] [DF600F      ] ...Claimed
      PhId[ 0] TId[ 5] Lun[ 1] [HITACHI ] [DF600F      ] ...Claimed
      PhId[ 0] TId[ 5] Lun[ 2] [HITACHI ] [DF600F      ] ...Claimed
      PhId[ 0] TId[ 6] Lun[ 0] [HITACHI ] [DF600F      ] ...Claimed
```

Figure 1-58: Portscan Subcommand

The output of the portscan subcommand includes:

- **Port:** Shows the port number on the device adapter recognized by the Windows system.
- **IID:** Shows the initiator ID on the specified device adapter port.
- **PhId:** Shows the BUS number on the specified device adapter port.
- **Tid:** Shows the target ID of the hard disks on the specified adapter port and bus.

- **LUN:** Shows the LU number of each hard disk on the specified device adapter port or bus. This item shows LDEV# of the partner who becomes a pair in or among the array.

Sync and syncd subcommands

The **sync** (synchronization) subcommand sends unwritten data remaining on the Windows 2000 or Windows Server to the specified devices. The **syncd** (synchronization delay) subcommand waits for delayed I/O to complete before synchronizing. [Table 1-30](#) lists and describes the sync and syncd subcommand parameters.

Table 1-30: Sync and Syncd Subcommand Parameters

Parameter	Value
Command Name	sync syncd
Format	-x sync[d] A: B: C: ... -x sync[d] all -x sync[d] drive#(0-N) ... -x sync[d] Volume#(0-N) ... -x sync[d] D:\directory or \directory pattern ... (Windows 2000/Windows Server systems only)
Argument	<p>A: B: C:[\directory or \directory pattern] ... : Specifies the logical devices that you want to synchronize. The data is flushed to the specified logical device and to the physical device that corresponds to the specified logical device.</p> <p>If a directory-mounted volume exists in the specified logical device, the data will be flushed including the directory-mounted volume as follows:</p> <pre>pairsplit -x sync D: [SYNC] D: HarddiskVolume2 [SYNC] D: \hd1 HarddiskVolume8 [SYNC] D: \hd2 HarddiskVolume9</pre> <p>[\directory or \directory pattern] (Windows 2000, Windows Server systems only) Specifies the directory or the directory pattern for searching the directory mount point in the logical device.</p> <p>If directory is specified: The applicable directory-mounted volume will be flushed.</p> <pre>pairsplit -x sync D:\hd1 [SYNC] D:\hd1 HarddiskVolume8</pre> <p>If directory patter is specified: The directory-mounted volume that matches the specified pattern will be flushed.</p> <pre>pairsplit -x sync D:\h [SYNC] D:\hd1 HarddiskVolume8 [SYNC] D:\hd2 HarddiskVolume9</pre>

Table 1-30: Sync and Syncd Subcommand Parameters (Continued)

Parameter	Value
Argument (continued)	<p>all: Synchronizes all logical devices. The logical device on which the CCI software is installed and the logical device containing the Windows 2000 or Windows Server directory is excluded.</p> <p>If a directory-mounted volume exists in the specified logical device, the data will be flushed including the directory-mounted volume as follows:</p> <pre>pairsplit -x sync all [SYNC] C: HarddiskVolume1 [SYNC] D: \hd1 HarddiskVolume8 [SYNC] D: \hd2 HarddiskVolume9 [SYNC] G: HarddiskVolume10</pre> <p>drive#(O-N) ...: Specifies the range of devices on the Windows 2000 or Windows Server system.</p> <p>Volume#(O-N) ...: Synchronizes the data to the specified LDM (logical device manager) volume.</p> <p>The LDM volume specifies the following device objects: \Vol#, \Dms#, \Dmt#, \Dmr#, or Volume{GUID}.</p>
Note	<p>The sync command executes the following procedures depending on the execution condition.</p> <p>If the logical device is closed from the application, the system buffer is flushed and changes the logical device to "Dismount" status.</p> <p>If the logical device is opened from the application, the sync option flushes the system buffer only. In this case, [WARNING] will be displayed.</p> <pre>pairsplit -x sync -C: WARNING: Only flushed to [\\.\C] drive due to be opening. [SYNC] C: HarddiskVolume3</pre> <p>If the logical drives designated as the objects of the sync command will not be opened to any applications, then the syncd command flushes the system buffer to a drive and holds the delayed (paging) I/O (30 sec). This avoids the problem where NTFS on the P-VOL will be split in an inconsistent state because Windows Server delays the I/O for dismounting.</p>

The following examples show the sync subcommand used as an option of the pairsplit command.

In the example in [Figure 1-59](#), the data remaining on logical devices C: and D: is written to disk; all pairs in the specified group are split (status = PSUS); and read/write access is enabled for all S-VOLs in the specified group.

```
pairsplit -x sync C: D: -g oradb
```

Figure 1-59: Sync Subcommand Example 1

In the example in [Figure 1-60](#), the data remaining on physical devices harddisk2 and harddisk3 is written to disk, all pairs in the specified group are deleted (status = SMPL), which enables read/write access for all secondary volumes.

```
pairsplit -x sync hdisk2 hdisk3 -g oradb -S
```

Figure 1-60: Sync Subcommand Example 2

Mount subcommand

The **mount** subcommand mounts the specified drive to the specified partition on the specified hard disk drive. If the mount subcommand is executed without specifying an argument, all drives that are currently mounted are displayed. [Table 1-31 on page 1-79](#) lists and describes the mount subcommand parameters.

For the directory mount, specify the mount point in the form of F:\ or D:\hdl (with \)

[Figure 1-61 on page 1-79](#) show examples of the mount subcommand used as an option of the pairsplit command output. Do not use the mountvol command to un-mount the volume if the volume was mounted using the -x mount command.



CAUTION! The partition on the specified disk drive (hard disk) must be recognized on the Windows 2000 or Windows Server system.

Correct Example:

```
% pairsplit -x mount F:
```

Wrong Example:

```
% pairsplit -x mount F:\mnt
```

Wrong Example:

```
% pairsplit -x mount F:\
```



CAUTION! To avoid Windows Server mount problems, set USE_MOUNTVOL_P of the environment variable. To avoid mount problems associated with event ID1, set this environment variable.



CAUTION! When directory mount is not used, logging off of Windows 2000 or Windows Server system will force the unmount. When logging off from Windows 2000 or Windows Server, avoid a forced unmount by executing the mount via the system account using a task scheduler, and so on



CAUTION! When using CCI on a Windows Servers system, use the USE_MOUNTVOL_P of the environment variable to avoid mount problems due to an event ID1 occurrence.

Table 1-31: Mount Subcommand Parameters

Parameter	Value
Command Name	mounts
Format	-x mount -x mount drive: Volume#(0-N) ... -x mount drive: [\[directory]] Volume#(0-N) ... (Windows 2000 and Windows Server systems only)
Arguments	Drive: [\[directory]] Volume#: For Windows 2000 and Windows Server systems, the drive specifies the logical device to be mounted. The hdisk# specifies the following device object names of the LDM volume to be mounted: hdisk#, \Vol#, \Dms#, \Dmt#, \Dmr#, or Volume{GUID} [\[directory]] Specifies the directory for specifying the directory mount point in the logical device. The character string of the directory cannot include space letters. pairsplit -x mount D:\hd1 \Vol8 D:\hd1 <+> HarddiskVolume8 pairsplit -x mount D:\hd2 \Vol9 D:\hd2 <+> HarddiskVolume9 If this command is executed without any argument, the device that is already mounted will be displayed.



NOTE: When mounting it by using the mountvol command supplied with Windows 2000 or Windows Server, the character string of the specified directory can include space letters (however, do not use the mountvol command when mounting the volumes created in array). When the character string includes a space (example: aaa bbb), it is indicated by adding "..." to the first character string in the mount command as shown in the following example.

```
pairsplit -x mount
Drive FS_name VOL_name Device Partition ... Port PathID Targ Lun
D: NTFS Null HarddiskVolume3 ... Harddisk2
D:\aaa... NTFS Null HarddiskVolume4 ... Harddisk3
```

If the command is executed without an argument, a mounted device that contains the directory-mounted volume will be displayed. If the mounted volume is an LDM volume, the physical drive (hard disk) number that configures the LDM volume will be displayed also.

The following example executes mount from the pairsplit command option, mounting the **F:** drive to the harddiskvolume2, after the mounted devices are displayed.

```
pairsplit -x mount F:\ hdisk2
pairsplit -x mount
Drive FS_name VOL_name Device Partition ... Port PathID Targ Lun
C: NTFS Null Harddiskvolume1 ... Harddisk0
F: NTFS Null Harddiskvolume2 ... Harddisk1
D: NTFS Null Harddiskvolume3 ... Harddisk2
D:\hd1 NTFS Null Harddiskvolume4 ... Harddisk3
D:\hd2 NTFS Null Harddiskvolume5 ... Harddisk4
G: NTFS Null HarddiskDmVolumes\ ... \Volume1 ... Harddisk5[3]
```

Figure 1-61: Mount Subcommand (Windows)

The output of the mount subcommand includes:

- **Drive:** Shows the logical device recognized by the Windows 2000 or Windows Server system.
- **FS_name:** Shows the name of the file system formatted on the specified drive.
- **VOL_name:** Shows the volume label name for the specified drive.
- **Device, Partition:** Shows the device name and partition for the specified drive.
- **Port, PathID, Targ, Lun:** Shows the port number, path ID (bus), target ID, and LUN for the specified drive.



Note 1: For Windows 2000 and Windows Server systems, if you specified both `hdisk#` and `partition#` arguments for the mount subcommand, the drive letters will not be displayed when the Disk Management is activated in the Control Panel → Administrative Tools → Computer Management → Storage folder. Even if this sub command is executed, a drive letter may not be assigned. In this case, the target volume may be used. Execute the command after making the target volume to unused status. Alternatively, a drive letter can be assigned by activating the Disk Management in the Control Panel → Administrative Tools → Computer Management → Storage folder.

Note 2: When using `Volume{guid}` as an argument for mount subcommand on Windows 2000 and Windows Server, the `Volume{guid}` of secondary volumes (S-VOL or V-VOL) of ShadowImage, SnapShot, TrueCopy or TCE is set by recognizing from OS by the Control Panel → Administrative Tools → Computer Management → Storage folder → Rescan Disks, while status is PSUS after pair create. Afterwards, the set `Volume{guid}` can be confirmed by `"inqraid.exe -CLI $Vol -fv"`. However, if `Volume{guid}` is already set when partition is already created at SMPL status before pair create, then `Volume{guid}` after pair create may not be recognized even if "re-scan disk" is done at PSUS status after pair create. In case of using `Volume{guid}` with secondary volumes (S-VOL or V-VOL), be sure to create pair when partition is not created to the secondary volume (S-VOL or V-VOL) before pair create.

Note 3: When making a secondary volume (S-VOL or V-VOL) of ShadowImage, SnapShot, TrueCopy, or TCE recognized by a host on Windows 2000 and Windows Server, place it in a state in which the pair is placed in the PSUS status after the pair has been created. If the pair status is changed to PSUS after the pair has been recognized by a host while it has been in the PSUS status, the pair may not operate correctly thereafter because the pair status is changed to that of the primary volume (P-VOL). To recognizing from host by the Control Panel → Administrative Tools → Computer Management → Storage folder → Rescan Disks, or reboot a host.

Unmount subcommand

The **umount** subcommand unmounts the specified logical drive and deletes the drive letter. Before deleting the drive letter, this subcommand executes sync internally for the specified logical drive and flushes unwritten data. [Table 1-32](#) lists and describes the unmount subcommand parameters. [Figure 1-62](#) shows an example of the unmount subcommand used as an option of the pairsplit command.

For the directory mount, specify the mount point in the form of F:\ or D:\hdl (with \).



CAUTION! The logical drive to be unmounted and the corresponding physical drive must be closed to all applications. On Windows Server 2012, the command will be forcefully executed, even if the drive is not closed.



CAUTION! To avoid the Windows Server 2003 or Windows Server 2008 mount problems, set USE_MOUNTVOL_P of the environment variable. To avoid mount problems associated with event ID1, set this environment variable.



NOTE: When Disk Management is started or the Rescan Disks is executed on Windows Server 2003, the Write command may be issued by Windows Server 2003. Besides, the Write command by Disk Management start or the Rescan Disks is also issued to a logical drive unmounted by the unmount sub-command. Therefore, when Disk Management is started or the Rescan Disk is executed in the status where a logical drive is not writable in the disk array, an error indicating a failure of writing to the logical drive may remain in the event log of Windows Server 2003 even though the logical drive in the write disabled status is unmounted. For example, because an S-VOL placed in the COPY or PAIR status by the pairresync is in the write disabled status, an error may remain in the event log of Windows Server 2003 when Disk Management is started or the Rescan Disks is executed even though the S-VOL is unmounted. The data has no problem even though an error remains in the event log of Windows Server 2003. If you do not want the error remained, execute the Rescan Disks before the logical drive is placed in the write disabled status by the pairresync command after unmounting the logical drive.

Procedure for the resync operation after unmounting the S-VOL:

1. Unmount the S-VOL by the unmount sub-command.
2. Execute the Rescan (that is equivalent to the Rescan Disks of Disk Management) of the diskpart command.
3. Wait for about 30 seconds.
4. Execute the pairresync command. (The S-VOL is changed to the write disabled status).



NOTE: Windows Server may write for the un-mounted volume. If a pair is resynchronized while maintaining data in the S-VOL on the memory of the server, the compatible backup cannot be performed. Therefore, execute the CCI sync command immediately before re-synchronizing the pair for the un-mounted S-VOL.

Table 1-32: Umount Subcommand Parameters

Parameter	Value
Command Name	umount
Format	-x umount drive: -x umount drive:[\directory] ... (Windows 2000 and Windows Server systems only)
Argument	drive: Specifies the mounted logical device. Drive:[\directory] : Specify the mounted logical device for drive . [\directory] : Specifies the directory for specifying the directory mount point in the logical device. pairsplit -x umount D:\hd1 D:\hd1 <-> HarddiskVolume8 pairsplit -x umount D:\hd2 D:\hd2 <-> HarddiskVolume9
Note	When the logical drive opened to applications, displayed as following. pairsplit -x umount D:\hd1 ERROR: Couldn't unmount [\\.\D:\hd1] due to be opening.

```

pairsplit -x umount F:\ -x umount G:\ -g oradb
pairsplit -x mount

Drive  FS_name  VOL_name  Device      Partition  ...  Port PathID  Targ  Lun
C:     FAT      Null     Harddisk0   Partition1 ...  1    0       0    0
Z:     Unknown  Unknown  CdRom0      ...        ...  Unknown

```

Figure 1-62: Umount Subcommand

This example unmounts the F: and G: drives, splits all pairs in the specified group (status = PSUS), enables read/write access to all secondary volumes in the specified group, and then displays all mounted drives.

The output of the umount subcommand includes:

- **Drive:** Shows the logical drive recognized by the Windows 2000 or Windows Server system.
- **FS_name:** Shows the name of the file system formatted on the specified drive.
- **VOL_name:** Shows the volume label name for the specified drive.
- **Device, Partition:** Shows the device name and partition for the specified drive.
- **Port, PathID, Targ, Lun:** Shows the port number, path ID (bus), target ID, and LUN for the specified drive.



Note 1: For Windows 2000 or Windows Server system, Even if this sub command is executed, a drive letter may not be deleted. In this case, the target volume may be used. Execute the command after making the target volume to unused status. Alternatively, a drive letter can be deleted by activating the Disk Management in the Control Panel → Administrative Tools → Computer Management → Storage folder.

Note 2: If you use the mount command with directory mount option on the Windows 2000 or Windows Server, the umount command must be used with directory mount option.

Correct example 1:

```
pairsplit -x mount F:\ hdisk2
pairsplit -x umount F:\
```

Correct example 2:

```
pairsplit -x mount F: hdisk2
pairsplit -x umount F:
```

Incorrect example:

```
pairsplit -x mount F:\ hdisk2
pairsplit -x umount F:
```

Environment variable subcommands

If no environment variables are set in the execution environment, the environment variable subcommand sets or cancels an environment variable within the CCI command. The setenv subcommand sets the specified environment variables. The unsetenv subcommand deletes the specified environment variables. The env subcommand command displays the environment variables. The sleep subcommand causes CCI to wait for the specified time. [Table 1-33](#) lists and describes the environment variable subcommands and their parameters.



CAUTION! The environment variables must be set before connecting to HORCM, and must be specified during interactive mode (-z option). Changing an environment variable after a CCI command execution error is invalid.

Table 1-33: Environment Variable Subcommand Parameters

Parameter	Value
Command Name	setenv usetenv env sleep
Format	-x setenv varname value -x usetenv varname -x env -x sleep time
Argument	Varname: Specifies the environment variable to be set or canceled. Value: Specifies the value or character string of the environment variable to be set. Time: Specifies the sleep time in seconds.

Figure 1-63 shows an example of the setenv subcommand used as an option of the raidscan command. This example changes from “TrueCopy/TCE” to “ShadowImage/SnapShot” an execution environment of the raidscan command which makes a dialog mode, because of establishing “HORCC_MRCF” as an environment variable.

Important: Always set HORCC_MRCF 1 for the ShadowImage/SnapShot/Data Retention.

```
raidscan[HORC]: -x setenv HORCC_MRCF 1
raidscan[MRCF]:

raidscan[MRCF]: -x usetenv HORCC_MRCF
raidscan[HORC]:
```

Figure 1-63: Environment Variable Subcommand

Command tools

Inqraid command tool

The **inqraid** command tool confirms the drive connection between the array and the host system. The inqraid command displays the relation between special files on the HP-UX system and actual physical drive of the array. [Table 1-34](#) lists and describes the inqraid command and parameters. [Figure 1-64](#) to [Figure 1-79](#) show examples of using inqraid and system commands to display the connection between the STDIN special file and the actual physical drive of array.

Table 1-34: Inqraid Command Parameters

Parameter	Value
Command Name	inqraid
Format	/HORCM/usr/bin/inqraid [-h quit -inqdump -fx[<i>l</i>][<i>g</i>][<i>w</i>] -find[<i>c</i>] <special file> -CLI -CLIWP -CLIWN sort -CM] \HORCM\etc\inqraid [-h quit -inqdump -fx[<i>l</i>][<i>g</i>][<i>w</i>] -find[<i>c</i>] <special file> -CLI -CLIWP -CLIWN sort -CM -gvinf -svinf]
Options	<p>-h: This option displays help and usage.</p> <p>quit: This option terminates from waiting STDIN and exits this command.</p> <p>-inqdump: This option displays information for standard inquiry with Dump Image of hexadecimal.</p> <p>-fx: This option displays the LDEV number with hexadecimal.</p> <p>-find [c]: This option searches a group on the configuration definition file (local instance) from <special file> of STDIN by using pairdisplay command, and uses the following options of the pairdisplay command to display its state. The -find option executes the following command (see Figure 1-72). pairdisplay -d <Seq#><LDEV> 0 1 2 -l [-fx] [-CLI] 2>/dev/null The -find[c] option executes the following command and then displays the result edited to CLI format (see Figure 1-72). pairdisplay -d <Seq#><LDEV><MU#> -fd -CLI 2>/dev/null</p> <p><special file>: This option is used to specify the special file name as argument of command.</p> <p>If no argument, this command makes mode that wait for STDIN without argument.</p> <p>-CLI: Displays the CLI. This option displays the CLI using one header and divides the column with space or with "-" (see Figure 1-77).</p> <p>-CLIWP and -CLIWN: For fibre channel, these options display the WWN of the host adaptor in CLI format. PWWN or NWWN will be displayed for WWN (see Figure 1-75, "Inqraid Command -CLIWP Option Example (Windows)", on page 1-90 also). For iSCSI, "0000000000000000" will be always displayed for WWN.</p> <p>-sort [-CM]: Sorts and displays the order of the array product number and the volume management number. The [-CM] option searches for command device from the specified special file (raw device file) provided via STDIN or argument input, and then displays only the command device in the image of the configuration definition file (see Figure 1-78).</p>

Table 1-34: Inqraid Command Parameters (Continued)

Parameter	Value
Options (continued)	<p>-gvinf: For Windows 2000 and Windows Server 2003 systems only.</p> <p>-gvinfex: For Windows Server 2003 GPT disk only. This option obtains the signature and the volume layout information from the device that is given by a standard input or by an argument, and saves (shelters) the information under the system device in the following format (see Figure 1-77, “Inqraid Command –gvinf Option Example”, on page 1-91 also). File format: \WindowsDirectory\VOLssss_####.ini (ssss indicates the serial number of the array, and #### indicates the LDEV number.) Usually, you do not need to be aware of this file, since the file is used by the Windows' Disk Management at the beginning when setting the S-VOL signature and the volume information.</p> <p>-svinf: For Windows 2000 and Windows Server systems only.</p> <p>-svinfex: For Windows Server GPT disk only. This option sets the saved (sheltered) signature and the system volume layout information of the system device into the device that is given by a standard input or by an argument. When setting the signature and the volume layout information to the device, the host issues the SCSI inquiry command, obtains the serial number of the array and the LDEV number, and then reads the applicable VOLssss_####.ini file. Therefore, even if the hard disk number is changed due to changing the configuration, the signature and the volume layout information will be set correctly since it is managed by the array serial number and the LDEV number. For [=PTN], specify a pattern for selecting the character string that is given as a device by a standard input or by an argument (see Figure 1-78, “Inqraid Command -svinf Option Example”, on page 1-91 also).</p> <p>-fv: This option is used with “\$Volume specification”. Volume{guid} of the appropriate volume is displayed in the wide format. Example: # inqraid -CLI \$Vol -fv DEVICE_FILE PORT SERIAL LDEV CTG H/M/12 SSID R:Group PRODUCT_ID Volume{cec25efe-d3b8-11d4-aead-00c00d003b1e}\Vol3\Dsk0 CL1-B 85002496 56 - - - - DF600F-CM</p> <p>-fl: Shows a data protection volume with “-CLI ” option by appending an asterisk (*) to the device file name.</p> <p>-fg: This option is specified to find host group and to display LUN.</p> <p>-fw: This option extends the contents of display, and indicates the V-VOL information to the maximum of MU#. This option is used by combining with the option of -CLI (see Figure 1-79).</p>
Returned values	<p>The -svinf or -svinfex option returns the following values to distinguish the execution result from you program: Normal termination: 0. Abnormal termination: 1 (when the execution to the specified device did not end normally).</p>

Table 1-34: Inqraid Command Parameters (Continued)

Parameter	Value
Restriction	<p>The special file of STDIN or Argument must be specified following name: HP-UX: /dev/rdisk/*, /dev/rdisk/disk*, /dev/rcdisk/disk* Solaris: /dev/rdsk/*s2, c*s2 AIX: /dev/rhdisk*, /dev/hdisk*, hdisk* Linux: /dev/sd*, /dev/rd*, /dev/raw/raw* Tru64 UNIX: /dev/rdisk/dsk*c IRIX: /dev/rdsk/*vol, /dev/rdsk/node_wwn/*vol/*, /dev/dsk/*vol, /dev/dsk/node_wwn/*vol/* Windows 2000 and Windows Server 2003 systems: hd0-10, harddisk0, harddisk1... (numbers indicate the drive number) \$LETALL, \$Volume, \$Phys, D:\Vol(Dms,Dmt, Dmr)X\DskY, \Vol(Dms,Dmt, Dmr)X\DskY Example: ls /dev/sd* ./inqraid echo /dev/sda /dev/sdb /dev/sdc ./inqraid</p>

```
ioscan -fun | grep rdsk | ./inqraid
/dev/rdsk/c0t2d1 -> [ST] CL2-A Ser =85003005 LDEV = 9 [HITACHI ] [DF600F ]
                HORC = SMPL HOMRCF[MU#0 = SMPL MU#1 = NONE MU#2 = NONE]
RAID5[Group 2- 0] SSID = 0x0000
/dev/rdsk/c0t4d0 -> [ST] CL2-A Ser =85003005 LDEV = 14 [HITACHI ] [DF600F-CM ]
```

Figure 1-64: Inqraid Command (HP-UX)

```
ls /dev/rdsk/* | ./inqraid
/dev/rdsk/c0t2d1s2 -> [ST] CL2-A Ser =85003005 LDEV = 9 [HITACHI ] [DF600F ]
                HORC = SMPL HOMRCF[MU#0 = SMPL MU#1 = NONE MU#2 = NONE]
                RAID5[Group 2- 0] SSID = 0x0000
/dev/rdsk/c0t4d0s2 -> [ST] CL2-A Ser =85003005 LDEV = 14 [HITACHI ] [DF600F-CM ]
```

Figure 1-65: Inqraid Command (Solaris)

```
lsdev -C -c disk | ./inqraid
hdisk10 -> [ST] CL2-A Ser =85003005 LDEV = 9 [HITACHI ] [DF600F ]
                HORC = SMPL HOMRCF[MU#0 = SMPL MU#1 = NONE MU#2 = NONE]
                RAID5[Group 2- 0] SSID = 0x0000
hdisk11 -> [ST] CL2-A Ser =85003005 LDEV = 14 [HITACHI ] [DF600F-CM ]
```

Figure 1-66: Inqraid Command (AIX)

```
ls /dev/sd* | inqraid
/dev/sdh -> CHNO = 0 TID = 1 LUN = 7
                [ST] CL2-A Ser =85003005 LDEV = 9 [HITACHI ] [DF600F ]
                HORC = SMPL HOMRCF[MU#0 = SMPL MU#1 = NONE MU#2 = NONE]
                RAID5[Group 2- 0] SSID = 0x0000
/dev/sdi -> CHNO = 0 TID = 4 LUN = 0
                [ST] CL2-A Ser =85003005 LDEV = 14 [HITACHI ] [DF600F-CM ]
```

Figure 1-67: Inqraid Command (Linux)

```
ls /dev/rdisk/dsk* | ./inqraid
/dev/rdisk/dsk10c -> [ST] CL2-A Ser =85003005 LDEV = 9 [HITACHI ] [DF600F ]
      HORC = SMPL HOMRCF[MU#0 = SMPL MU#1 = NONE MU#2 = NONE]
      RAID5[Group 2- 0] SSID = 0x0000
/dev/rdisk/dsk11c -> [ST] CL2-A Ser =85003005 LDEV = 14 [HITACHI ] [DF600F-CM ]
```

Figure 1-68: Inqraid Command (Tru64 UNIX)

```
echo hd10-11 | .\inqraid
Harddisk10 -> [ST] CL2-A Ser =85003005 LDEV = 9 [HITACHI ] [DF600F ]
      HORC = SMPL HOMRCF[MU#0 = SMPL MU#1 = NONE MU#2 = NONE]
      RAID5[Group 2- 0] SSID = 0x0000
Harddisk11 -> [ST] CL2-A Ser =85003005 LDEV = 14 [HITACHI ] [DF600F-CM ]
```

Figure 1-69: Inqraid Command (Windows)

```
ls /dev/rdsk/*vol | ./inqraid
/dev/rdsk/dks1d6vol -> [ST] CL2-A Ser =85003005 LDEV = 9 [HITACHI ] [DF600F ]
      HORC = SMPL HOMRCF[MU#0 = SMPL MU#1 = NONE MU#2 = NONE]
      RAID5[Group 2- 0] SSID = 0x0000
/dev/rdsk/dks1d7vol -> [ST] CL2-A Ser =85003005 LDEV = 14 [HITACHI ] [DF600F-CM ]
```

Figure 1-70: Inqraid Command (IRIX FC_AL)

```
ls /dev/rdsk/**vol/* | ./inqraid
/dev/rdsk/50060e8000100262/lun3vol/c8p0 -> [ST] CL2-A Ser =85003005 LDEV =
9 [HITACHI ] [DF600F ]
      HORC = SMPL HOMRCF[MU#0 = SMPL MU#1 = NONE MU#2 = NONE]
      RAID5[Group 2- 0] SSID = 0x0000
/dev/rdsk/50060e8000100262/lun4vol/c8p0 -> [ST] CL2-A Ser =85003005 LDEV =
14 [HITACHI ] [DF600F-CM ]
```

Figure 1-71: Inqraid Command (IRIX Fabric Fibre)

The output of the inqraid command includes:

- **CLX-Y:** Shows the port number.
- **Ser:** Shows the serial number.
- **LDEV:** Shows the LDEV ID. LDEV indicates LU.
- **HORC:** Shows TrueCopy/TCE attributes (P-VOL/S-VOL/SMPL) of the volume.
- **HOMRCF:** Shows ShadowImage/SnapShot attributes (P-VOL, S-VOL, SMPL) of the volume for MU#. (**Note**)
- **Group:** Shows the array (parity) group ID (physical position of the volume in the array). LDEV indicates LU. (**Note**)
- **SSID:** Shows the array ID of the volume. LDEV indicates LU. (**Note**)
- **CHNO:** Channel number on the device adapter that recognizes the volume. Displayed only for Linux systems.
- **TID:** Target ID of the volume. Displayed only for Linux systems.

- **LUN:** Logical unit number of the volume. Displayed only for Linux systems.



NOTE: The display of HOMRCF, Group, and SSID depends on the array firmware level.

```
C:\HORCM\etc>echo hd01 hd03 | inqraid -find
Group   PairVol(L/R) (Port#,TID,LU-M) ,Seq#,LDEV#.P/S,Status, Seq#,P-LDEV# M
horcl   dev00(L)    (CL2-A , 0,  0-0)85006145      0.S-VOL SSUS, ----- 9  -
->Harddisk1
Group   PairVol(L/R) (Port#,TID,LU-M), Seq#,LDEV#, P/S, Status, Seq#, P-LDEV# M
horcl   dev10(L)    (CL2-A , 2,  3-0)85006145      3.S-VOL SSUS, ----- 6  -
->Harddisk3
```

Figure 1-72: Inqraid Command -find Option (Windows)

```
C:\HORCM\etc>echo hd01 hd03 | inqraid -findc
DEVICE_FILE      M Group   PairVol  P/S   Stat  R_DEVICE      M P/S   Stat  LK
Harddisk1        0 horcl   dev00    S-VOL SSUS  Harddisk2     0 P-VOL PSUS  OK
Harddisk1[1]    -> No such on the group
Harddisk1[2]    -> No such on the group
DEVICE_FILE      M Group   PairVol  P/S   Stat  R_DEVICE      M P/S   Stat  LK
Harddisk3        0 horcl   dev10    S-VOL SSUS  Harddisk4     0 P-VOL PSUS  OK
Harddisk3[1]    -> No such on the group
Harddisk3[2]    -> No such on the group

C:\HORCM\etc>echo hd01 hd03 | inqraid -findc -CLI
DEVICE_FILE      M Group   PairVol  P/S   Stat  R_DEVICE      M P/S   Stat  LK
Harddisk1        0 horcl   dev00    S-VOL SSUS  Harddisk2     0 P-VOL PSUS  OK
Harddisk3        0 horcl   dev10    S-VOL SSUS  Harddisk4     0 P-VOL PSUS  OK
```

Figure 1-73: Inqraid Command -findc Option (Windows)

The output of the inqraid command with `-find` (and `-findc`) includes:

- **DEVICE_FILE:** Shows only the device file name.
- **M:** Shows the MU#.
- **Group:** Shows the group name (dev_group) described in the configuration definition file.
- **PairVol:** Shows the paired volume name (dev_name) of the group described in the configuration definition file.
- **P/S:** Shows the volume attribute (P-VOL, S-VOL, SMPL).
- **Stat:** Shows the status of the paired volume.
- **R_DEVICE:** Shows the device file name of the remote site.
- **LK:** Shows the configuration check result for the paired volume connection path (physical link of the paired volumes between the hosts).

```
# ls /dev/sd* | ./inraid -CLI
DEVICE_FILE      PORT      SERIAL  LDEV  H/M/12  SSID R:Group  PRODUCT_ID
sdh              CL2-B    85003005  23   -/P/--  0004 5:02-00  DF600F
sdi              CL2-B    85003005  14   -      -      -      DF600F-CM
sdj              -        -        -    -      -      -      -
```

Figure 1-74: Inraid Command -CLI Option (Linux)

The output of the inraid command with -CLI includes:

- **DEVICE_FILE:** Shows only the device file name.
- **PORT:** Shows the port name of the array.
- **SERIAL:** Shows the product number of the array.
- **LDEV:** Shows the volume management number in the array. LDEV indicates LU.
- **H/M/12:** Shows the volume attribute (P-VOL is indicated as P, S-VOL is indicated as S, and SMPL is indicated as s).
- **SSID:** Shows the array ID where LDEV is allocated. LDEV indicates LU.
- **R:Group:** Shows the position of the physical CCI group mapped in LDEV. LDEV indicates LU.
- **PRODUCT_ID:** Shows the product ID in the standard inquiry page.

```
1018 - CL2-A - 85006145 12 DF600F
```

```
C:\HORCM\etc>echo hd01 hd03 | inraid -CLIWP
DEVICE_FILE      PWWN          AL PORT      LUN  SERIAL  LDEV  PRODUCT_ID
Harddisk1        500060e802f01018 - CL2-A    -    85006145  11  DF600F
Harddisk3        500060e802f0
```

Figure 1-75: Inraid Command -CLIWP Option Example (Windows)

The output of the inraid command with -CLIWP includes:

- **DEVICE_FILE:** Shows only the device file name.
- **WWN (PWWN or NWWN):** For fibre channel, if -CLIWP option is specified, this option shows the Port_WWN of the host adaptor for the specified device. If -CLIWN option is specified, this option shows the Node_WWN of the host adaptor. For iSCSI, "0000000000000000" will be always displayed.
- **AL and LUN:** Shows a hyphen (-) all the time.
- **PORT:** Shows the port name of the array.
- **SERIAL:** Shows the product number of the array.
- **LDEV:** Shows the volume management number in the array. LDEV indicates LU.
- **PRODUCT_ID:** Shows the product ID in the standard inquiry page.

```
C:\HORCM\etc>echo hd0-10 | inqraid -sort -CM -CLI
HORCM_CMD
# dev_name          dev_name          dev_name
#UnitID 0 (Serial# 85003001)
\\.\PhysicalDrive6
```

Figure 1-76: Inqraid Command -sort[-CM] Option (Windows)



NOTE: The unit ID is added in the order of the array's product number. If multiple command devices exist within the array, the device file that is used to share between the array port would be chosen in prior, and is used as alternate command device.

The following is an example of using the **-gvinf** option of the inqraid command. The information in all physical drives will be saved (sheltered) by giving \$Phy.

```
D:\HORCM\etc>inqraid $Phys -gvinf -CLI
\\.\PhysicalDrive0:
\ Harddisk0 -> [VOL85006145_448_DA7C0D91] [DF600F ]
\\.\PhysicalDrive1:
\ Harddisk1 -> [VOL85006145_449_DA7C0D92] [DF600F ]
\\.\PhysicalDrive2:
\ Harddisk2 -> [VOL85006145_450_DA7C0D93] [DF600F ]
```

Signature
LDEV number
Array serial number

Figure 1-77: Inqraid Command -gvinf Option Example

The following is an example of using the **-svinf** option of the inqraid command. The information is set to the hard disk number indicated by the pairdisplay command that is issued from S-VOL instance.

```
D:\HORCM\etc>pairdisplay -l -fd -g URA
Group PairVol(L/R) Device_File M ,Seq#,LDEV#.P/S, Status, Seq#,P-LDEV# M
URA URA_000(L) Harddisk3 0 85006145 51.S-VOL SSUS,----- 48 -
URA URA_001(L) Harddisk4 0 85006145 52.S-VOL SSUS,----- 49 -
URA URA_002(L) Harddisk5 0 85006145 53.S-VOL SSUS,----- 50 -

D:\HORCM\etc>pairdisplay -l -fd -g URA | inqraid -svinf=Harddisk
[VOL85006145_51_5296A763] -> Harddisk3 [DF600F ]
[VOL85006145_52_5296A760] -> Harddisk4 [DF600F ]
[VOL85006145_53_5296A761] -> Harddisk5 [DF600F ]
```

Figure 1-78: Inqraid Command -svinf Option Example

Important: If you have created a pair using a noread option, the device object (\Device\HarddiskVolume#) and the Volume{guid} of the S-VOL will not be generated at the time when the Windows is booted in Noread status. However, executing the pairsplit command, and then executing the inqraid **-svinf** command results in generation of the device object (\Device\HarddiskVolume#) and the Volume{guid}.

The hard disk volume number of the device object is generated in the order of the command that the Windows issued. Therefore, the same number will be maintained unless the configuration is changed. However, if you want the hard disk volume number to be absolute, add the `-sort` option, as shown in the example below, so that the serial number of the array and the LDEV number will be sorted in numbers.

Example:

```
D:\HORCM\etc>echo hd5 hd4 hd3 | inqraid -svinf -sort
[VOL85006145_51_5296A763] -> Harddisk3      [DF600F      ]
[VOL85006145_52_5296A760] -> Harddisk4      [DF600F      ]
[VOL85006145_53_5296A761] -> Harddisk5      [DF600F      ]
```

The following is an example of using the `-fw` option of the `inqraid` command.

```
C:\horcm\etc>inqraid $Phy -CLI -fw
DEVICE_FILE      PORT      SERIAL  LDEV CTG  H../M/..      SSID R:Group
PRODUCT_ID
Harddisk0        -         -       -   -   -         -         - FIREBALL CR6
Harddisk1        -         -       -   -   -         -         - PSEUDO LUN
Harddisk2        CL1-A    85000008  1   -   -         -         - DF600F-CM
Harddisk3        CL1-A    85000008  2   -   s/P/PPssssssssSP 0000 5:00-00 DF600F
```

Figure 1-79: Inqraid Command -fw Option Example (Windows)

Mkconf command tool

The **mkconf** command executes the following operation and creates a configuration definition file automatically from the special file via STDIN. The user must edit the created configuration definition file as needed.

1. The mkconf command executes **inqraid –sort –CM –CLI** and then creates a configuration definition file only for HORCM_CMD.
2. The mkconf command starts the HORCM instance using the created definition file.
3. The mkconf command executes **raidscan –find conf** by using the special file via STDIN, and then creates the definition file that contains HORCM_DEV and HORCM_INST.
4. The mkconf command starts the HORCM instance again to verify the created definition file.
5. The mkconf command executes **raidscan –find verify** and displays the correspondence between the special files via STDIN with the definition file.

Table 1-35: Mkconf Command Parameters

Parameter	Value
Command Name	mkconf
Format	/HORCM/usr/bin/mkconf.sh [-g[g] <group> [-m <mu#>] [-l <inst#>] [-s <service>] [-a]] \HORCM\etc\ mkconf.exe [-g[g] <group> [-m <mu#>] [-l <inst#>] [-s <service>] [-a] [-c <drive>]]
Options	<p>If no argument, this command creates a mode that waits for STDIN without argument.</p> <p>-g[g] <group>: This option specifies the group described in the configuration definition file. If omitted, "VG" is used for the group name. -gg option is specified to find host group and to display LUN.</p> <p>-m <MU#>: This option specifies the mirror descriptor MU#.</p> <p>-l <inst>: This option shows the instance number.</p> <p>-s <service>: This option specifies the service name (port number) described in the configuration definition file. If omitted, "52323" is used for the port number.</p> <p>-a: This option adds a group to an already created configuration definition file.</p> <p>-c <drive>: This option specifies the range of the command device to be searched. If omitted, "\$PhysicalDrive" is used for <drive>.</p>
Note	The configuration definition file and the log file are created in the current directory as horcm*.conf or log* (* as an instance number). The user must edit the created configuration definition file as necessary (such as ip_addresses, and services).



WARNING! If you create the configuration definition file using the mkconf command tool, remember to change poll('0ms) manually. Setting the value incorrectly may cause a conflict between the CCI and the array, which causes the internal process of the array to suspend temporary.

```

C:\HORCM>type C:\HORCM\usr\bin\horcm.conf | C:\HORCM\Tool\mkconf.exe -g ORA -i
9 -m 0
starting HORCM inst 9
HORCM inst 9 starts successfully.
HORCM Shutdown inst 9 !!!
A CONFIG file was successfully completed.
starting HORCM inst 9
HORCM inst 9 starts successfully.
DEVICE_FILE          Group   PairVol   PORT   TARG  LUN M   SERIAL  LDEV
Harddisk1            ORA    ORA_000   CL2-A   0    0 0    85006145  0
Harddisk2            ORA    ORA_001   CL2-A   0    1 0    85006145  1
Harddisk3            ORA    ORA_002   CL2-A   0    2 0    85006145  2
Harddisk4            ORA    ORA_003   CL2-A   0    3 0    85006145  3
Harddisk5            ORA    ORA_004   CL2-A   0    4 0    85006145  4
Harddisk6            ORA    ORA_005   CL2-A   0    5 0    85006145  5
Harddisk6            -      -         -       -    - 0    85006145  -
HORCM Shutdown inst 9 !!!
Please check 'C:\HORCM\horcm9.conf', 'C:\HORCM\log9\curlog\horcm*_log.txt', and
modify
ip_address & service'.

C:\HORCM>dir /b
horcm9.conf
log9
Tool
usr

C:\HORCM>type horcm9.conf
# Created by mkconf on Tue Sep 11 17:11:41

HORCM_MON
#ip_address          service          poll(10ms)      timeout(10ms)
localhost           52323           1000 [Note]        3000

HORCM_CMD
#dev_name            dev_name          dev_name
#UnitID 0 (Serial# 85006145)
\\.\PhysicalDrive6

HORCM_DEV
#dev_group          dev_name          port#           TargetID        LU#           MU#
# Harddisk1         SER = 85006145   LDEV =          0 [ FIBRE FCTBL = 4 ]
ORA                 ORA_000          CL2-A           0               0             0
# Harddisk2         SER = 85006145   LDEV =          1 [ FIBRE FCTBL = 4 ]
ORA                 ORA_001          CL2-A           0               1             0
# Harddisk3         SER = 85006145   LDEV =          2 [ FIBRE FCTBL = 4 ]
ORA                 ORA_002          CL2-A           0               2             0
# Harddisk4         SER = 85006145   LDEV =          3 [ FIBRE FCTBL = 4 ]
ORA                 ORA_006          CL2-A           0               6             0
# ERROR [CMDDEV] Harddisk5
SER = 85006145   LDEV =          7 [ DF600F-CM
]

HORCM_INST
#dev_group          ip_address        service
ORA                 localhost         52323

```

Figure 1-80: Mkconf Command Example (Windows)



NOTE: Remember to change the value of poll('0ms) parameter using the equation.

Unit Ids are added in the order of the array product number. If multiple command devices exist in the array, the device file that was shared between the ports of the array will be selected, and will be handled as an alternative command device.

If the standard input device includes a command device, the target device will be displayed as the comment shown below and will be omitted.

Example:

```
# ERROR [CMDDEV] Harddisk5          SER =85006145  LDEV = 7 [DF600F-CM  ]
```

If the standard input device is shared between several command devices and is already displayed as a target device, the target device will be displayed as the comment shown below and will be omitted.

Example:

```
# ERROR [LDEV LINK] Harddisk5      SER =85006145  LDEV = 3 [FIBRE FCTBL = 4]
```

If the standard input device does not have an appropriate mirror descriptor (MU#), the target device will be displayed as the comment shown below and will be omitted.

Example:

```
# ERROR [LDEV MUN (2<1)] Harddisk5  SER =85006145  LDEV = 3 [DF600F  ]
```

If the device from the standard input co-reside between arrays with different mirror control, the target device will be displayed as the comment shown below and will be omitted.

Example:

```
# ERROR [MIXING RAID TYPE] Harddisk5  SER =85006145  LDEV = 3 [DF600F  ]
```

Host group control

The array has the defined host group in the port and is able to allocate host LU every this host group. CCI does not use this host LU, and specifies by using absolute LUN in the port. Therefore, a user can become confused because LUN of the CCI notation does not correspond to LUN on the host view. Thus, CCI supports a way of specifying a host group and LUN on the host view.

Specifying a host group

1. Define the formats.

The way what CCI has addition of argument for the host group to the raidscan command and the configuration file will not be able to maintain the compatibility with conventional CLI. Therefore, CCI adopts a way that supports in the form which specifies a host group in the port strings as follows.

- CL1-A-**GRP#** (GRP# are up to 127)
 - * Specifying the host group for the raidscan command as follows:

```
raidscan -p CL1-A-5
```

- * Specifying the host group for the configuration file

#dev_group	dev_name	port#	TargetID	LU#	MU#
ORA	ORA_000	CL1-A-1	4	1	0
ORA	ORA_001	CL1-A-1	4	2	0

If the port including a host group is specified to the port name, then maximum of specifiable LUNs are up to 255.

2. Specify the port strings. CCI supports four formats:

- Specifying the Port name without a host group
CL1-A
CL1-A**n** where **n**: unit ID for multiple RAID
- Specifying the Port name with a host group
CL1-A-**g** where **g**: host group
CL1-A**n-g** where **n-g**: host group=**g** on CL1-A in unit ID=**n**

Commands and options including a host group

1. Specifiable command for host group. The following commands are able to specify a host group with the port strings:

- raidscan -p <port>, raidar -p <port>, raidvchkscan -p <port>

```
# raidscan -p CL2-D-1
PORT# /ALPA/C,TID#,LU#.Num(LDEV#....)...P/S, Status,Fence,LDEV#,P-Seq#,P-LDEV#
CL1-A-1 /da/ 0, 4, 0.1(256).....SMPL ---- - - - - - - - - , - - - - - - - -
CL1-A-1 /da/ 0, 4, 1.1(257).....SMPL ---- - - - - - - - - , - - - - - - - -
CL1-A-1 /da/ 0, 4, 2.1(258).....SMPL ---- - - - - - - - - , - - - - - - - -
```

2. New option including a host group. CCI supports new option for the following commands in order to show a LUN on the host view by finding a host group via the specified device.

- **raidscan -pdg <device>, raidar -pdg <device>, raidvchkscan -pdg <device>**

```
# raidscan -pdg /dev/rdisk/c57t4d1
PORT# /ALPA/C,TID#,LU#.Num(LDEV#....)...P/S, Status,Fence,LDEV#,P-Seq#,P-
LDEV#
CL1-A-1 /da/ 0, 4, 0.1(256).....SMPL ---- - - - - - , - - - - -
CL1-A-1 /da/ 0, 4, 1.1(257).....SMPL ---- - - - - - , - - - - -
CL1-A-1 /da/ 0, 4, 2.1(258).....SMPL ---- - - - - - , - - - - -
Specified device(hgrp=1) is LDEV# 0257
```

- **raidscan -findg**

```
# ls /dev/rdisk/c57* | raidscan -findg
DEVICE_FILE      UID  S/F PORT  TARG  LUN   SERIAL  LDEV  PRODUCT_ID
/dev/rdisk/c57t4d0  0    F  CL1-A-1  4     0    85001000  256  DF600F-CM
/dev/rdisk/c57t4d1  0    F  CL1-A-1  4     1    85001000  257  DF600F
/dev/rdisk/c57t4d2  0    F  CL1-A-1  4     2    85001000  258  DF600F
```

- **raidscan -findg conf, mkconf -gg**

```
# ls /dev/rdisk/c57* | raidscan -findg conf 0 -g ORA
HORCM_DEV
#dev_group      dev_name      port#      TargetID     LU#      MU#
# /dev/rdisk/c57t4d1  SER = 85001000  LDEV = 257 [ FIBRE FCTBL = 4 ]
ORA             ORA_000      CL1-A-1    4            1        0
# /dev/rdisk/c57t4d2  SER = 85001000  LDEV = 258 [ FIBRE FCTBL = 4 ]
ORA             ORA_001      CL1-A-1    4            2        0
```

- **inqraid -fg**

```
# ls /dev/rdisk/c57* | ./inqraid -CLI -fg
DEVICE_FILE      PORT      SERIAL  LDEV CTG  H/M/12  SSID R:Group  PRODUCT_ID
c57t4d0          CL1-A-1  85001000  256  -    -      -      -      DF600F-CM
c57t4d1          CL1-A-1  85001000  257  -    s/P/ss  0000 1:01-02  DF600F
c57t4d2          CL1-A-1  85001000  258  -    s/P/ss  0000 1:01-02  DF600F
```

Volume migration

Overview

Volume Migration is a function to migrate a logical volume to the other RAID group in the AMS array. CCI operates in cooperation with software on the host and Volume Migration of the AMS array and provides a function to control Volume Migration by CLI commands.

Specifications

To make CCI execute the migration by operating Volume Migration, it is required to map the migration destination volume to a port or a host group that is not connected to a host beforehand. [Figure 1-81](#) is the execution example of the volume migration executed for LDEV#18.

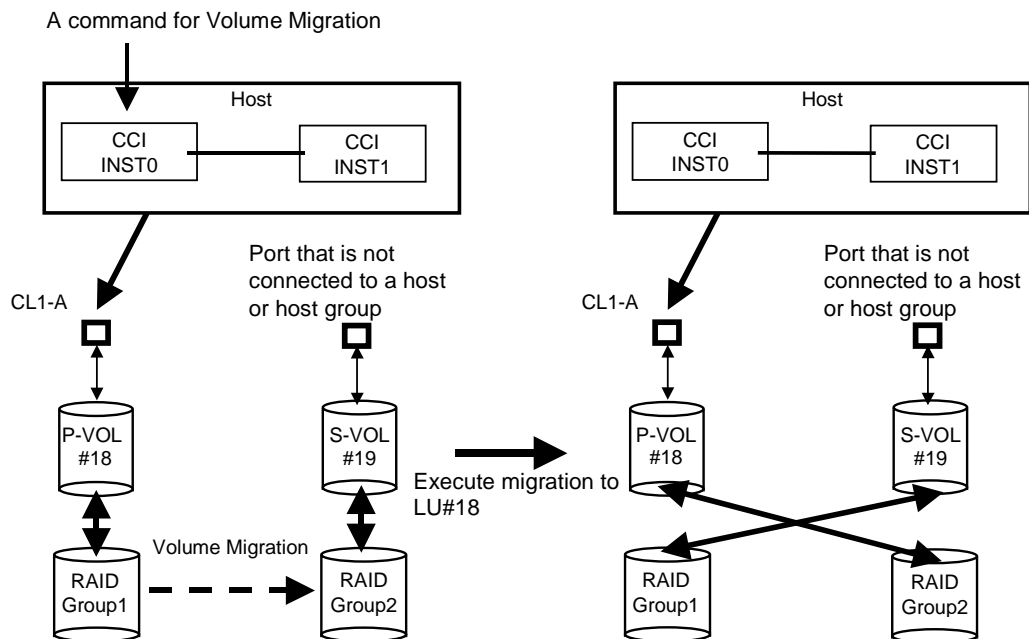

Figure 1-81: Volume Migration Configurations

- **Command specification**
To operate Volume Migration using CCI, it is required to define the mapping of the migration source volume and the migration destination volume. The volumes are registered in the horcm*.conf file of CCI in the same way as ShadowImage to define the mapping. When the remote instance is instructed to execute the migration by Volume Migration, the volume of the remote instance is interpreted as the migration source volume and a volume of the local instance is made to be the migration destination volume.
- **Group operation**
It is possible to perform an operation of Volume Migration for a group through a description in the horcm*.conf file of CCI, but the data consistency of a group for which the command has been executed is not maintained. When a host crashes while the command is executed

for the group, the command execution is interrupted halfway and LUs in statuses different from each other may exist.

- HORCM instance
It is possible to describe a volume to be operated by Volume Migration in the horcm*.conf file, in which a volume to be operated by the other function such as ShadowImage is described, as the other group in duplicate. It is also possible to define a volume to be operated by Volume Migration in the other horcm*.conf file than that for a volume to be operated by the other function such as ShadowImage and to operate it from the independent HORCM instance.

Commands to control the Volume Migration

Table 1-36 lists and describes the Volume Migration command parameters.

- Command for volume migration
CCI supports the volume migration by adding an option (**-m cc**) to the paircreate command.

Table 1-36: Command for Volume Migration

Parameter	Value
Command Name	paircreate
Format	paircreate -g <group> -d <pair Vol> -m cc -vl[r] -c <size>
Options	<p>-m cc: This option instructs the copying of the volume migration to be made. Note: This option cannot be specified with “-split” option in the same command.</p> <p>-vl (-pvol) or -vr (-svol): Specifies the data flow direction and must always be specified. The -vl (-pvol) specifies the local instruction, that is, an instruction to copy a local instance LU (P-VOL) to a remote instance LU (S-VOL) and to maps a copying destination volume (a volume of the remote instance) to the local instance LU (P-VOL). The -vr (-svol) specifies the remote instruction, and copies data from a remote instance LU (P-VOL) to a local instance LU (S-VOL) and maps a copy destination volume (a volume of the local instance) to the remote instance LU (P-VOL).</p> <p>-c <size>: You can use this option to specify the copying pace (1 - 15) to be used for the initial data copy. You can shorten the copy time by specifying a large number. Do not use the default value 3. (1 to 5: slow, 6 to 10: normal, 11 to 15: prior) If a copying is made at the “normal” pace when the host I/O load is heavy, the host I/O performance may be deteriorated remarkably. When you want to prevent the host I/O performance being deteriorated, select the “slow” pace. Select the “prior” pace only when you want to give much priority to the time for the completion of the copy than the host I/O performance in a period of time when the P-VOL is rarely accessed.</p>

- Confirming the migration pair status
You can check that the RAID group to which the LU that executed the migration belongs has been changed by referring to the RAID group to which the LU concerned belongs using the inqraid command.

```

C:\HORCM\etc>echo hd0 | inqraid
Harddisk0 -> [ST] CL1-A Ser =85000067 LDEV = 1 [HITACHI ] [DF600F ]
          HORC = SMPL HOMRCF[MU#0 = S-VOL MU#1 = SMPL MU#2 = SMPL]
          RAID5[Group 1- 0] SSID = 0x0000

C:\HORCM\etc>paircreate -g vg01 -m cc -v1

C:\HORCM\etc>echo hd0 | inqraid
Harddisk0 -> [ST] CL1-A Ser =85000067 LDEV = 1 [HITACHI ] [DF600F ]
          HORC = SMPL HOMRCF[MU#0 = S-VOL MU#1 = SMPL MU#2 = SMPL]
          RAID5[Group 2- 0] SSID = 0x0000

```

The LU has been migrated to the other RAID group.

Figure 1-82: Inqraid Command Example

Relations between “cc” command issues and status

The migration volumes can be handled by issuing the CCI commands (pair creation and pair splitting commands). The validity of the specified operation is checked according to the status of the paired volume (primary volume). [Table 1-37](#) shows the relations between the migration volume statuses and command acceptances.

Table 1-37: Command Issues and Pairing Status Transition

Command Command option	paircreate	
	-m cc	-S
① SMPL	Accepted ②→③ ②→④	Acceptable
② COPY	Acceptable	Accepted ①
③ PSUS		Accepted ①
④ PSUE		Accepted ①

- **Accepted:** A command is accepted and executed. When the command execution succeeds, the status changes to that of the shown number.
- **Acceptable:** No operation is executed, though a command is accepted.
- **Shaded portions:** Command execution is rejected and the operation terminates abnormally.



Note 1: Other commands and option (that is, pairresync...) for operating a paired-volume are rejected.

Note 2: The “-m cc” option cannot be specified with “-split” option in the same command.

Synchronous waiting command (pairsyncwait)

Table 1-38 lists and describes the pair synchronization waiting command parameters and returned values. The pairsyncwait is a command exclusive for TCE. It is a command to check whether or not the data written immediately after the issue of the command is reflected on the S-VOL of the remote site. This command gets the latest sequence # of local array (P-VOL latest sequence # within the CT group) and the sequence # of remote array within the CT group which correspond to the <group> or <raw_device> that is specified by pairsyncwait, and compares local array with remote array sequence # at that time and at regular interval. Because the sequence number is updated for each group, you can check whether the S-VOL data has been updated or not by executing the command specifying a group when all the pairs in the target group are in the PAIR status.

If remote array sequence # is over the value of local array sequence # within the term that was specified by pairsyncwait, this command reports the return code 0 with the meaning of completion of synchronization. The -nowait option shows the latest sequence # (Q-marker) of local array P-VOL and CTGID. The marker is shown in hexadecimal of ten characters.

Table 1-38: Pairsyncwait Command Parameters

Parameter	Value
Command Name	pairsyncwait
Format	pairsyncwait { -h -q -z -I[H M][instance#] -g <group> -d <pair Vol> -d[g] <raw_device> [MU#] -d[g] <seq#> <LDEV#> [MU#] -t <timeout> -nowait [-m <marker> -nomsg] }
Options	<p>-h: Displays help, usage, and version information.</p> <p>-q: Terminates the interactive mode and exits the command.</p> <p>-z or -zx: Makes the raidvchksan command enter the interactive mode. The -zx option guards performing of the HORCM in the interactive mode. When this option detects a HORCM shut down, interactive mode terminates.</p> <p>-I[H M][instance#] or -I[TC SI][instance#]: Specifies the instance number and the command execution environment. Refer to Instance number and option for command execution environment on page 1-4.</p> <p>-g <group>: Specifies a group name defined in the configuration definition file. The command is executed for each CTG unless the -d <pair Vol> option is specified. The execution result of the pairsyncwait command for each option, see Table 1-39 and Table 1-40.</p> <p>-d <pair Vol>: Specifies a paired logical volume name defined in the configuration definition file. When this option is specified, the command is executed for the specified paired logical volumes.</p> <p>-d[g] <raw_device> [MU#]: Searches a group on the configuration definition file (local instance) for the specified raw_device, and if the specified raw_device is contained in the group, the target volume is executed as the paired logical volume (-d) or group (-dg). This option is effective without specifying the "-g <group>" option. If the specified the raw_device is contained in two or more groups, the command is executed on the first group.</p>

Table 1-38: Pairsyncwait Command Parameters (Continued)

Parameter	Value
Options (continued)	<p>-d[g] <seq#> <LDEV#> [MU#]: Searches a group on the configuration definition file (local instance) for the specified LDEV, and if the specified LDEV is contained in the group, the target volume is executed as the paired logical volume (-d) or group (-dg). This option is effective without specifying the "-g <group>" option. If the specified LDEV is contained in two or more groups, the command is executed on the first group. The <seq #> <LDEV #> values can be specified in hexadecimal (by addition of "0x") or decimal notation.</p> <p>-t <timeout>: Specifies the timeout value to wait for the completion. The unit is 100 ms. Local array gets the latest sequence # from remote array at regular interval.</p> <p>-nowait: Gets the latest sequence # of local array P-VOL and CTGID without waiting. When this option is specified, the latest sequence # of local array P-VOL is reported immediately, and -t <timeout> option is ignored.</p> <p>-nomsg: Suppresses messages to be displayed when this command is executed. It is used to execute a command from a user program. This option must be specified at the beginning of a command argument. The command execution log is not affected by this option.</p> <p>-m <marker>: Specifies the sequence # of local array P-VOL, called the Q-marker. If the application gets Q-marker as the result of execution of pairsyncwait because of timeout or "-nowait", the application can reconfirm the completion of asynchronous transfer by using pairsyncwait with Q-marker. If the application does not specify Q-marker, CCI uses the latest sequence # when CCI receives pairsyncwait. It is also possible to wait for the completion from S-VOL side with this option.</p> <p>Q-Marker format: = iisssssss, where ii = incarnation # of pair volume, and sssssss = P-VOL serial #.</p>
Returned values	<p>When the -nowait option is specified:</p> <p>Normal termination: 0: The status is NOWAIT.</p> <p>Abnormal termination: other than 0 to 127, refer to the execution logs for error details.</p> <p>When the -nowait option is not specified:</p> <p>Normal termination: 0: The status is DONE (completion of synchronization).</p> <p>1: The status is TIMEOUT (timeout).</p> <p>2: The status is BROKEN (Q-marker synchronized process is rejected).</p> <p>3: The status is CHANGED (Q-marker is invalid due to resynchronize).</p> <p>Abnormal termination: other than 0 to 127, refer to the execution logs for error details.</p>

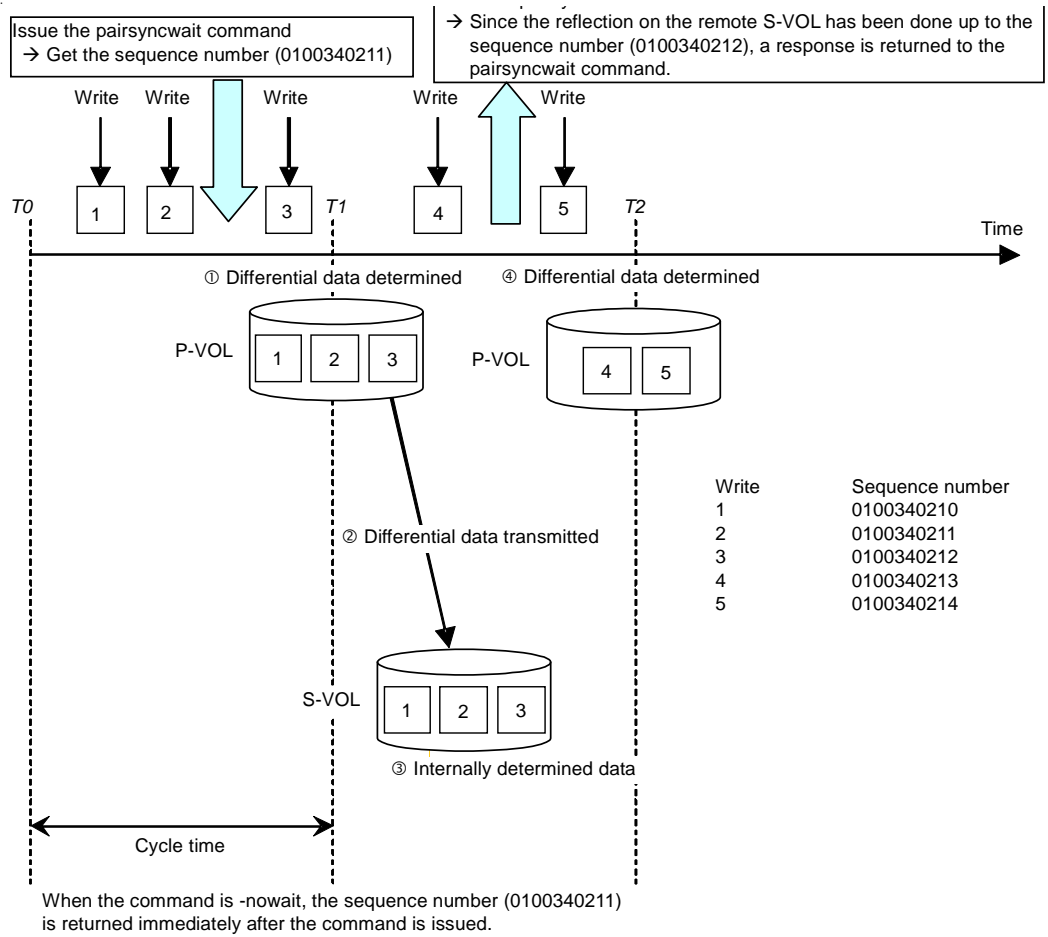

```
# pairsyncwait -g oradb -nowait ← -nowait is specified.
UnitID  CTGID    Q-Marker  Status   Q-Num
      0      3    01003408ef  NOWAIT    2

# pairsyncwait -g oradb -t 100 ← -nowait is not specified.
UnitID  CTGID    Q-Marker  Status   Q-Num
      0      3    01003408ef  DONE      2

# pairsyncwait -g oradb -t 1
UnitID  CTGID    Q-Marker  Status   Q-Num
      0      3    01003408ef  TIMEOUT   3

# pairsyncwait -g oradb -t 100 -m 01003408ef
UnitID  CTGID    Q-Marker  Status   Q-Num
      0      3    01003408ef  DONE      0

# pairsyncwait -g oradb -t 100
UnitID  CTGID    Q-Marker  Status   Q-Num
      0      3    01003408ef  BROKEN    0

# pairsyncwait -g oradb -t 100 -m 01003408ef
UnitID  CTGID    Q-Marker  Status   Q-Num
      0      3    01003408ef  CHANGED   0

⚠ Q Marker(01003408ef) is invalid when P-VOL was
resynchronized while this command is executed.
```

Figure 1-83: Pairsyncwait Command Examples

The output of the pairsyncwait command is:

- **UnitID:** Unit ID in case of multiple array connection
- **CTGID:** CTGID within Unit ID
- **Q-Marker:** The latest sequence # of local array P-VOL (marker) when the command is received.
- **Status:** The status after the execution of command.
- **Q-Num:** The number of process queue to wait for synchronization within the CTGID.

Execute the pairsyncwait command only when the target pair statuses are all PAIR. It can also be executed when the target pair status is other than PAIR, but the output result becomes as it is shown in the table below.

Table 1-39: Command is Issued to the Primary Array in which a TCE Pair has been Created

Options	Result
-g or -g -nowait	The command can be executed when a status of a pair, which is defined as the lead pair of the specified group in the configuration definition file, is PAIR.
-d or -d -nowait	The command can be executed when the status of the specified pair is PAIR.
-g, -m, or -d -m	The command can be executed even when a single pair in the PAIR status exists in the specified group.

Table 1-40: Command is Issued to the Secondary Array in which a TCE Pair has been Created

Options	Result
-g, -d, -g -nowait, or -d -nowait	Cannot executed
-g -m, or -d -m	The command can be executed even when a single pair in the PAIR status exists in the specified group.

Troubleshooting

This chapter includes the following troubleshooting information:

- ❑ [ShadowImage troubleshooting](#)
- ❑ [SnapShot troubleshooting](#)
- ❑ [TrueCopy troubleshooting](#)
- ❑ [TCE troubleshooting](#)
- ❑ [General troubleshooting](#)
- ❑ [Error reporting](#)
- ❑ [Data recovery for PSUE using ShadowImage](#)
- ❑ [Data recovery for PSUE using SnapShot](#)
- ❑ [Data recovery for PSUE using TrueCopy and TCE](#)

ShadowImage troubleshooting

A hardware failure can cause a ShadowImage pair failure, in which case you will have to restore the pair status.

If you perform a forced pair release, the pair status changes to PSUE (as it does for a pair failure) and you must restore the pair status.

If DP-VOLs are used for the LUs configuring a pair, a pair failure can occur, depending on the consumed capacity of the DP pool, and the pair status may become PSUE.

If the DP-VOL created in the DP pool is used for a ShadowImage pair, a pair failure may occur since the required area cannot be allocated. If a failure occurs during the DP pool formatting, wait for the formatting of the DP pool for total capacity of the DP-VOLs created in the DP pool to complete. If a failure occurs due to DP pool capacity depletion, you can return the DP pool status to normal by performing the DP pool capacity growing and DP pool optimization operations and increasing the DP pool free capacity.

If a hardware error occurs while you are operating ShadowImage, both of the following are necessary:

- A CCI user intervention
- Assistance from a Hitachi Customer Service representative

For example, when formatting is needed to resolve an LU error and that LU is used for ShadowImage, the pair must be released by you (CCI operation by you) before the LU can be formatted. Therefore, please contact Hitachi personnel because maintenance requires you to issue CCI commands. Hitachi personnel can only remove errors which result from hardware. An operation such as recovering a ShadowImage pair status (for example, resynchronizing) must be done by you.

[Figure 2-1 on page 2-3](#) shows the flow of action when the PSUE error occurs.

[Table 2-1 on page 2-3](#) shows the share of action to be taken by you.

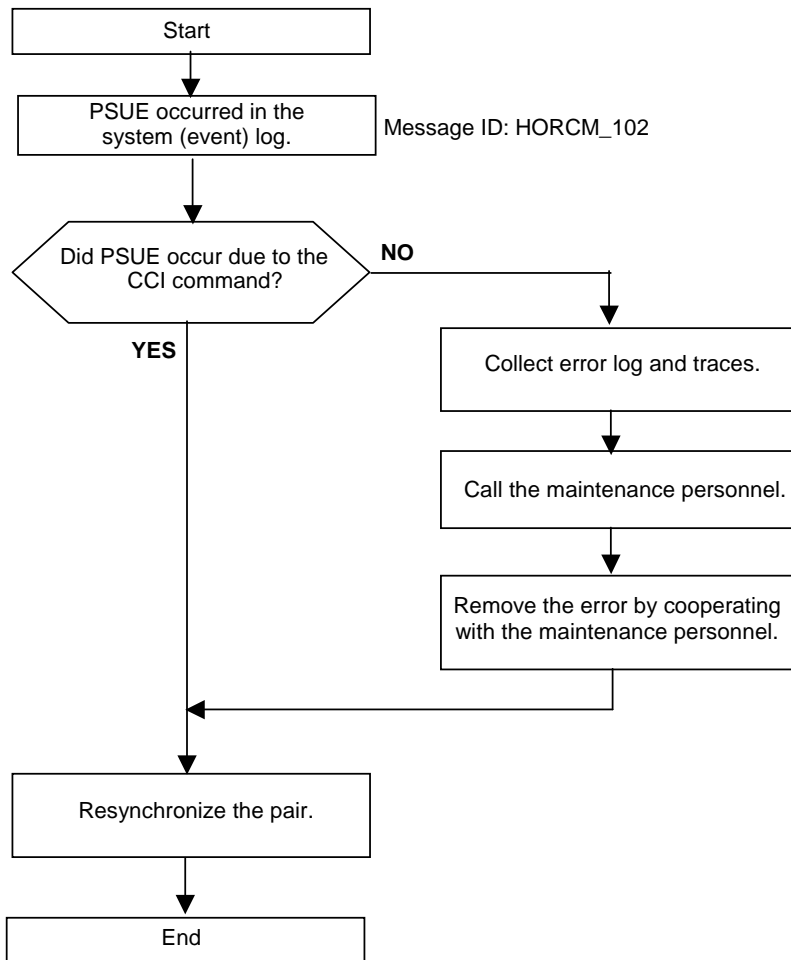

Figure 2-1: Pair Status Information Example Using ShadowImage

Table 2-1: ShadowImage Operational Notes

Action	Action taken by whom
Confirm the message (syslog).	User
Verify that PSUE is caused by you operation.	User
Verify the status of the array.	User
Call maintenance personnel when the array malfunctions.	User
For other reasons, call the Hitachi support center.	User (only for users that are registered in order to receive a support)
Hardware maintenance.	Hitachi Customer Service
Reconfigure and recover the pair.	User

SnapShot troubleshooting

If a hardware error occurs while you are operating SnapShot, both of the following are necessary:

- A CCI user intervention
- Assistance from a Hitachi Customer Service representative

There are three causes of PSUE status induced during an operation of SnapShot: an insufficient data pool capacity (full of the data pool), DP pool capacity is depleted, and an occurrence of a logically abnormal status caused by a hardware failure. When the data pool capacity is insufficient, split all pairs that have been placed in the PSUE status. After that, check if the configuration including the data pool capacity and number of V-VOLs is appropriate because it is judged that the system configuration has a problem. After the check is finished, carry out an operation of SnapShot for recovering a pair status (such as paircreate). All those operations are to be done by a user. For example, when formatting is needed to resolve an LU error and that LU is used for SnapShot, the pair must be released by you (CCI operation by you) before the LU can be formatted. Therefore, please contact Hitachi personnel because maintenance requires you to issue CCI commands. Note that the Hitachi personnel can only remove errors which result from hardware. An operation such as recovering a SnapShot pair status (for example, paircreate) must be done by you.

When the DP-VOL created in the DP pool is used for a SnapShot pair, a pair failure can occur since the required area cannot be allocated. If a failure occurs during the DP pool formatting, wait for the formatting of the DP pool for total capacity of the DP-VOLs created in the DP pool to complete. If a failure occurs due to the DP pool capacity depletion, for making the DP pool status normal, perform the DP pool capacity growing and DP pool optimization, and increase the DP pool free capacity.

For example, when formatting is needed to resolve an LU error and that LU is used for SnapShot, the pair must be released by you (CCI operation by you) before the LU can be formatted. Therefore, please contact Hitachi personnel because maintenance requires you to issue CCI commands. Note that the Hitachi personnel can only remove errors which result from hardware. An operation such as recovering a SnapShot pair status (for example, paircreate) must be done by you. Figure 2.2 shows the flow of action when the PSUE error occurs. Table 2.2 shows the share of action to be taken by you

[Figure 2-2 on page 2-5](#) shows the flow of action when the PSUE error occurs.

[Table 2-2 on page 2-5](#) shows the share of action to be taken by you.

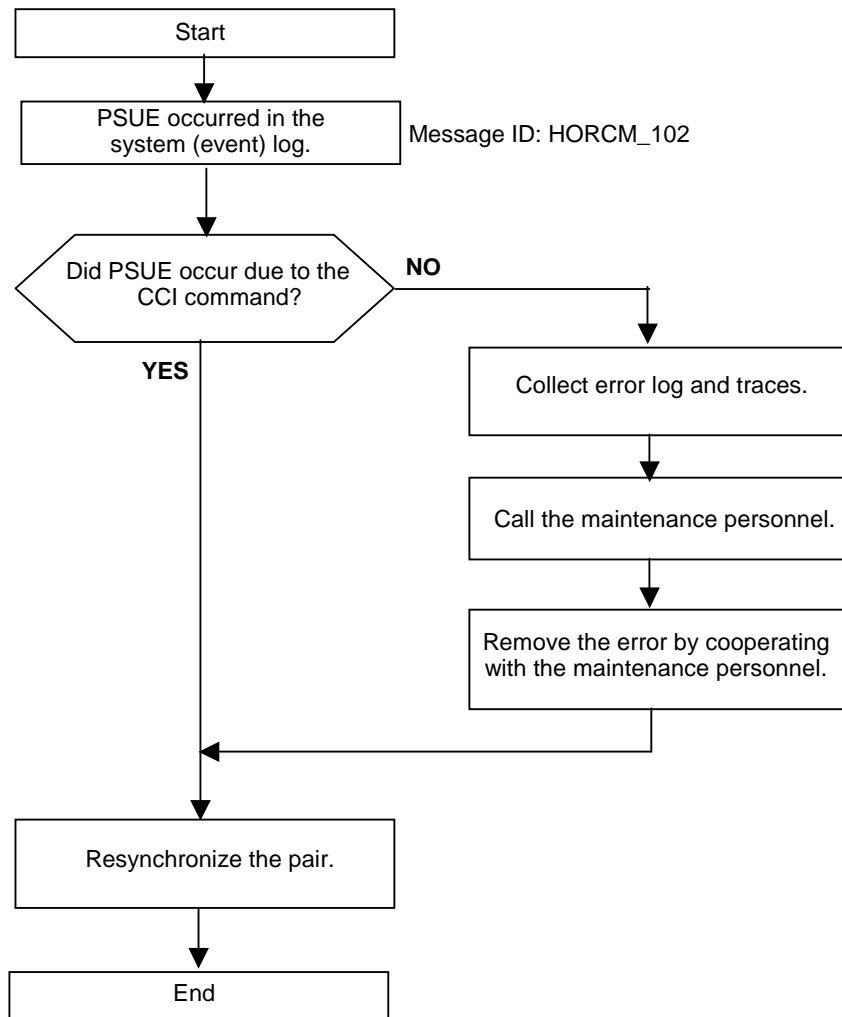

Figure 2-2: Pair Status Information Example Using SnapShot

Table 2-2: SnapShot Operational Notes

Action	Action taken by whom
Confirm the message (syslog).	User
Refer to the information message issued by the array built in Web Server (a shortage of a POOL capacity).	User
Verify the status of the array.	User
Call maintenance personnel when the array malfunctions.	User
For other reasons, call the Hitachi support center.	User (only for users that are registered in order to receive a support)
Split the pair.	User
Hardware maintenance.	Hitachi Customer Service
Reconfigure and recover the pair.	User

TrueCopy troubleshooting

If the following problem occurs, the pair status is changed to PSUE:

- The path is detached
- A logical abnormal state occurs due to problems with the storage system
- An abnormal state occurs from causes unrelated to the storage system

If a hardware or Fibre path error occurs while you are operating the TrueCopy, both of the following are necessary:

- A CCI user intervention
- Assistance from a Hitachi Customer Service representative

For example, when formatting is needed to resolve an LU error and that LU is used for TrueCopy, the pair must be released by you (CCI operation by you) before the LU can be formatted. Therefore, please contact Hitachi personnel because maintenance requires you to issue CCI commands. Note that the Hitachi personnel can only remove errors which result from hardware. An operation such as recovering the TrueCopy pair status (for example, resynchronizing) must be done by you.

[Figure 2-3 on page 2-7](#) shows the flow of action when the PSUE error occurs.

[Table 2-3 on page 2-10](#) shows the share of action to be taken by you.

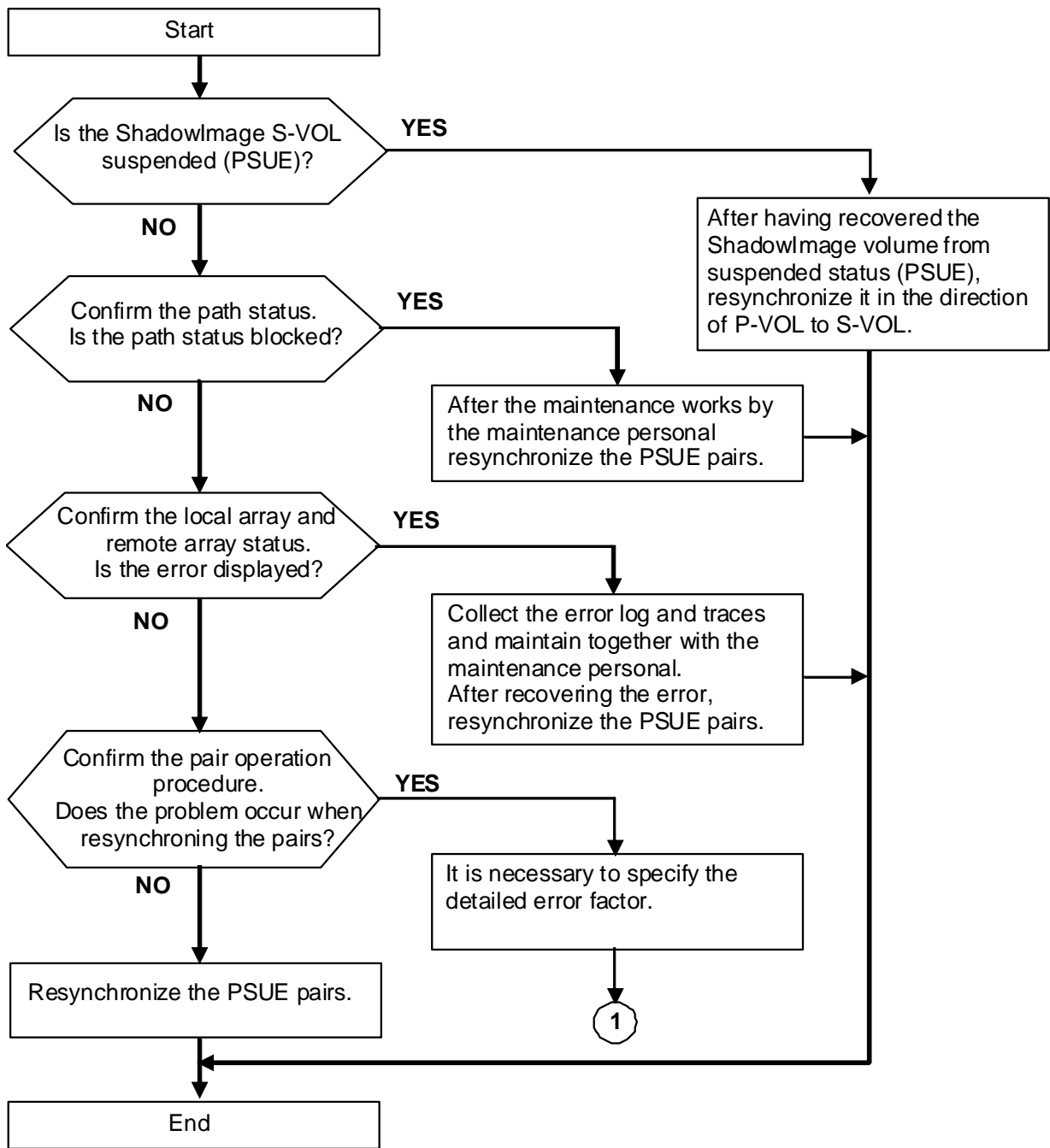

Figure 2-3: Pair Status Information Example Using TrueCopy

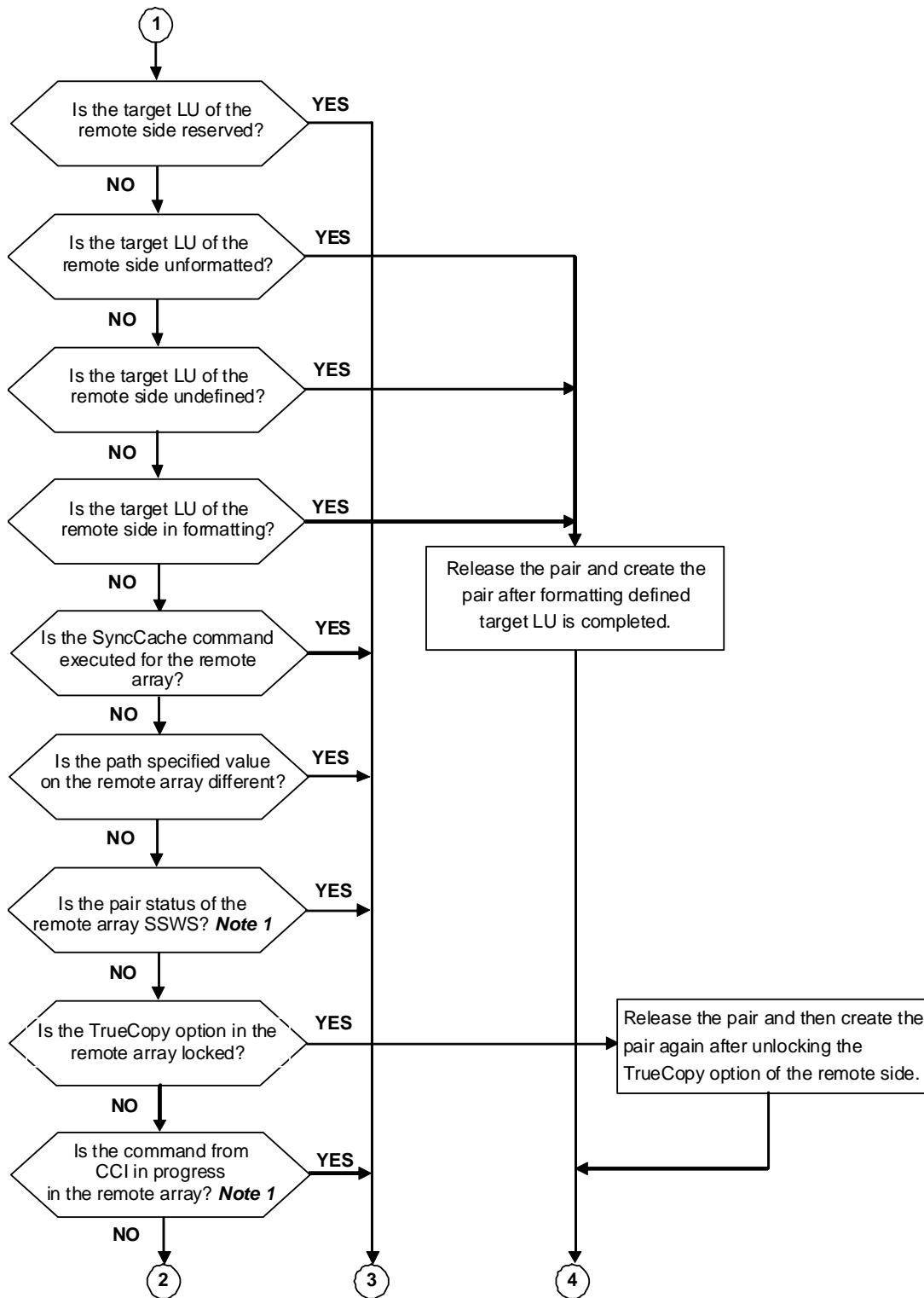

Figure 2-3: Pair Status Information Example Using TrueCopy (continued)



NOTE: If a swap from S-VOL to P-VOL is in progress, the pairs cannot be resynchronized from P-VOL to S-VOL.

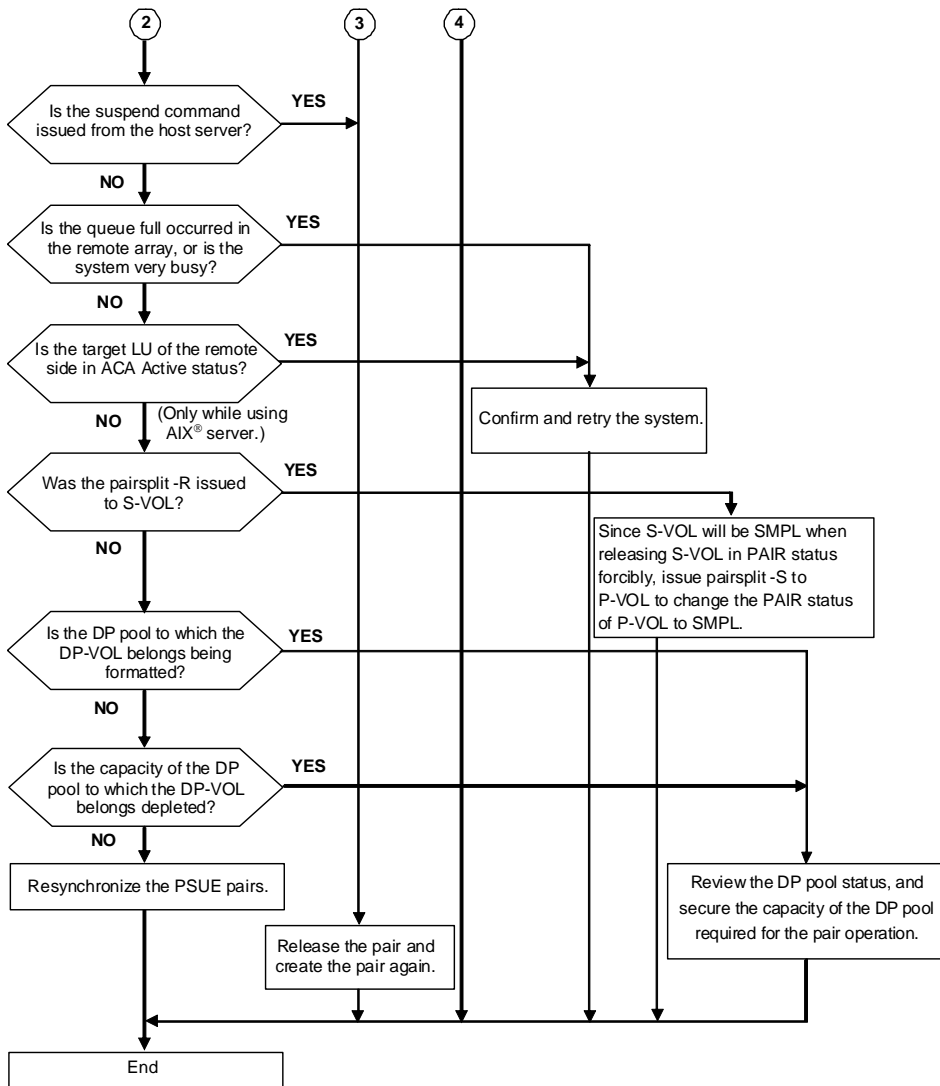

Figure 2-3: Pair Status Information Example Using TrueCopy (continued)

When an error occurs in the Fibre route between arrays while operating TrueCopy, the path is blocked. The system maintenance by the Hitachi personnel is necessary. Figure 2-4 shows the flow of the failure isolation while the path blockage occurred.

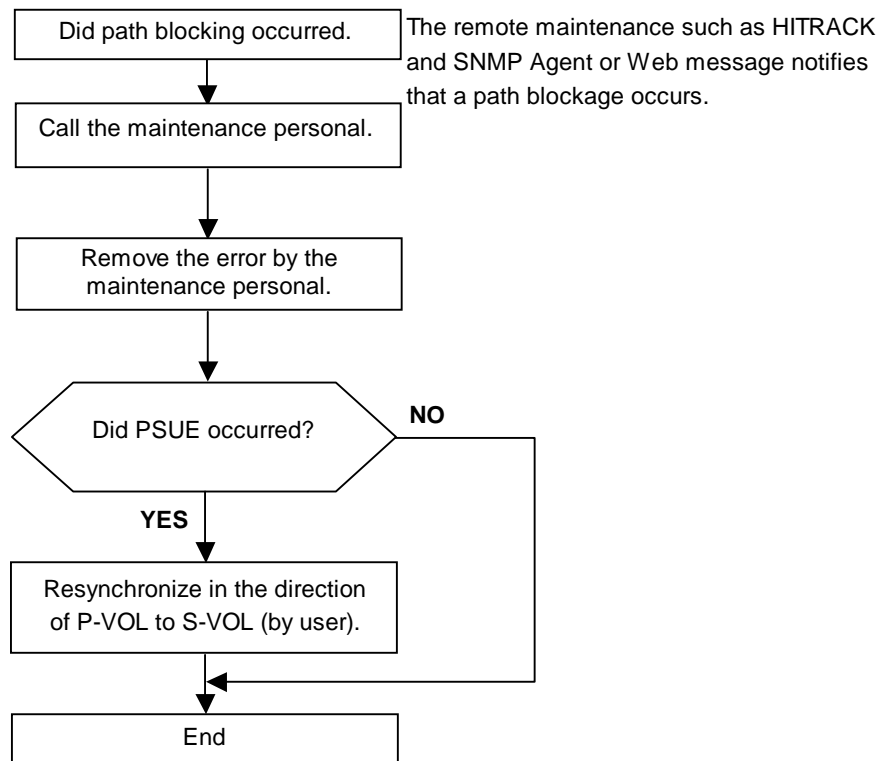

Figure 2-4: Path Status Information Example Using TrueCopy

Table 2-3: TrueCopy Operational Notes

Action	Action taken by whom
Confirm the message (syslog).	User
Confirm whether PSUE is caused by you operation.	User
Confirm the status of the array.	User
Call the maintenance personnel when the array malfunctions.	User
For other reasons, call the Hitachi support center.	User (only for users that are registered in order to receive a support)
Hardware maintenance (including path blockage).	Hitachi Customer Service
Reconfigure and recover the pair.	User

TCE troubleshooting

If the following problem occurs, the pair status changes to PSUE:

- The amount of the data in the data pool exceeds the capacity allowed for use
- A path detach operation occurs
- A logical abnormal state occurs due to problems with the storage system
- An abnormal state occurs from causes unrelated to the storage system

If a hardware or Fibre path error occurs while you are operating the TCE, both of the following are necessary:

- A CCI user intervention
- Assistance from a Hitachi Customer Service representative

When the amount of the data in the data pool exceeds the capacity allowed to be used, you should:

1. Resynchronize all pairs whose data pools have a PSUE or PFUS status.
2. Check whether the configuration, including the data pool capacity and number of V-VOLs (when concurrent use of SnapShot), is appropriate.
3. Perform a TCE operation to recover a pair status (such as paircreate).

For example, when formatting is needed to resolve an LU error and that LU is used for TCE, the pair must be released by you (CCI operation by you) before the LU can be formatted. Therefore, please contact Hitachi personnel because maintenance requires you to issue CCI commands. Note that the Hitachi personnel can only remove errors which result from hardware. An operation such as recovering the TCE pair status (for example, resynchronizing) must be done by you.

[Figure 2-5 on page 2-12](#) shows the flow of action when the PSUE error occurs.

[Table 2-4 on page 2-15](#) shows the share of action to be taken by you.



Note 1: In the case of TCE, even when one of the pairs belonging to the same CTG is placed in the PSUE status, all the pairs in the CTG are placed in the PSUE status because the change to the PSUE status is made in units of CTG. However, concerning the pair in the PSUS status, the status is not changed to PSUE but left as it is.

Note 2: In the case where the data pool-over occurs in the secondary data pool, it is reported to the P-VOL after the S-VOL status is changed to PFUS and the P-VOL status is changed to PSUE. On the other hand, when the data pool-over occurs in the primary data pool, only the P-VOL status is changed to PFUS and the change of the S-VOL status does not occur.

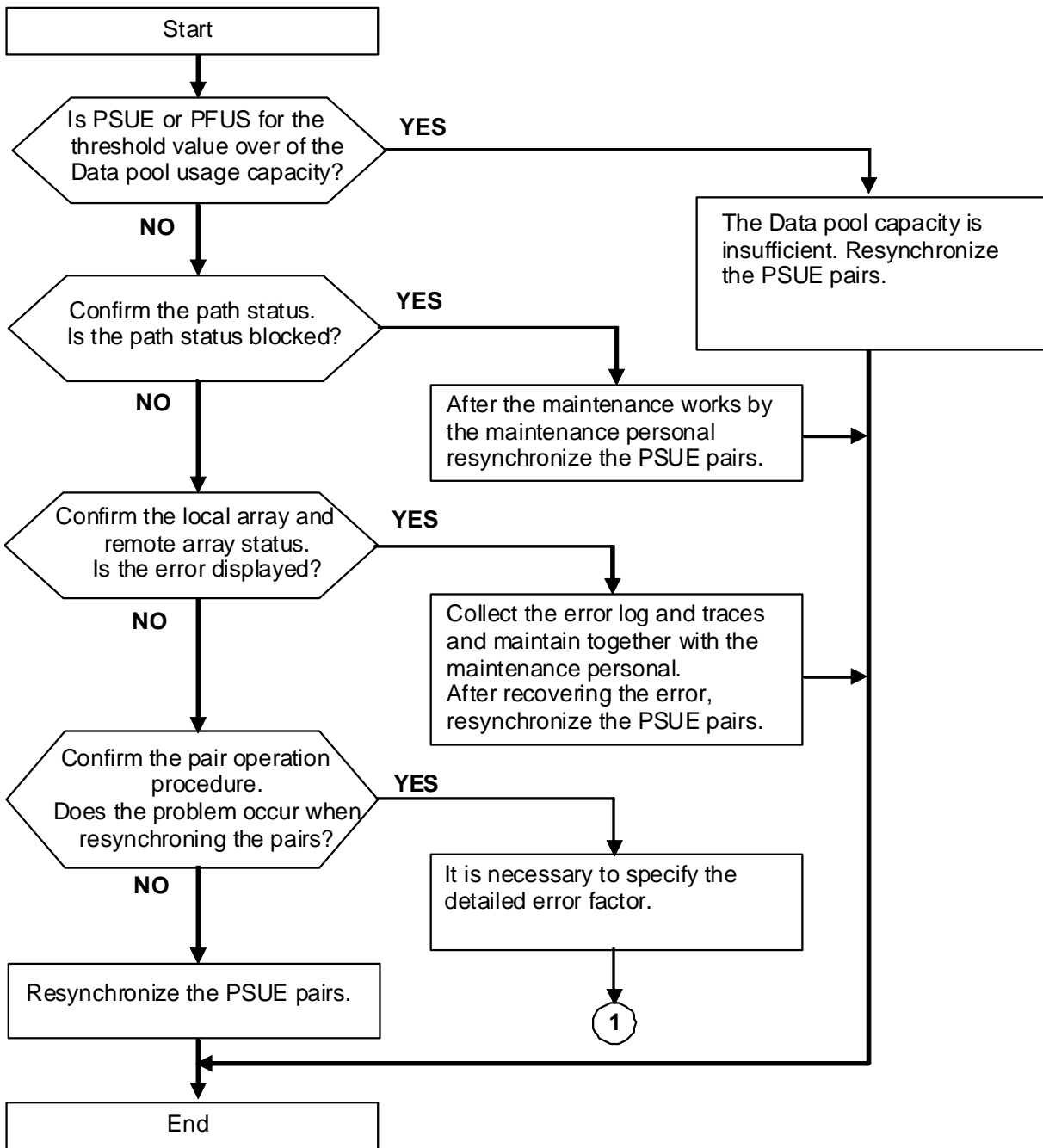

Figure 2-5: Pair Status Information Example Using TCE

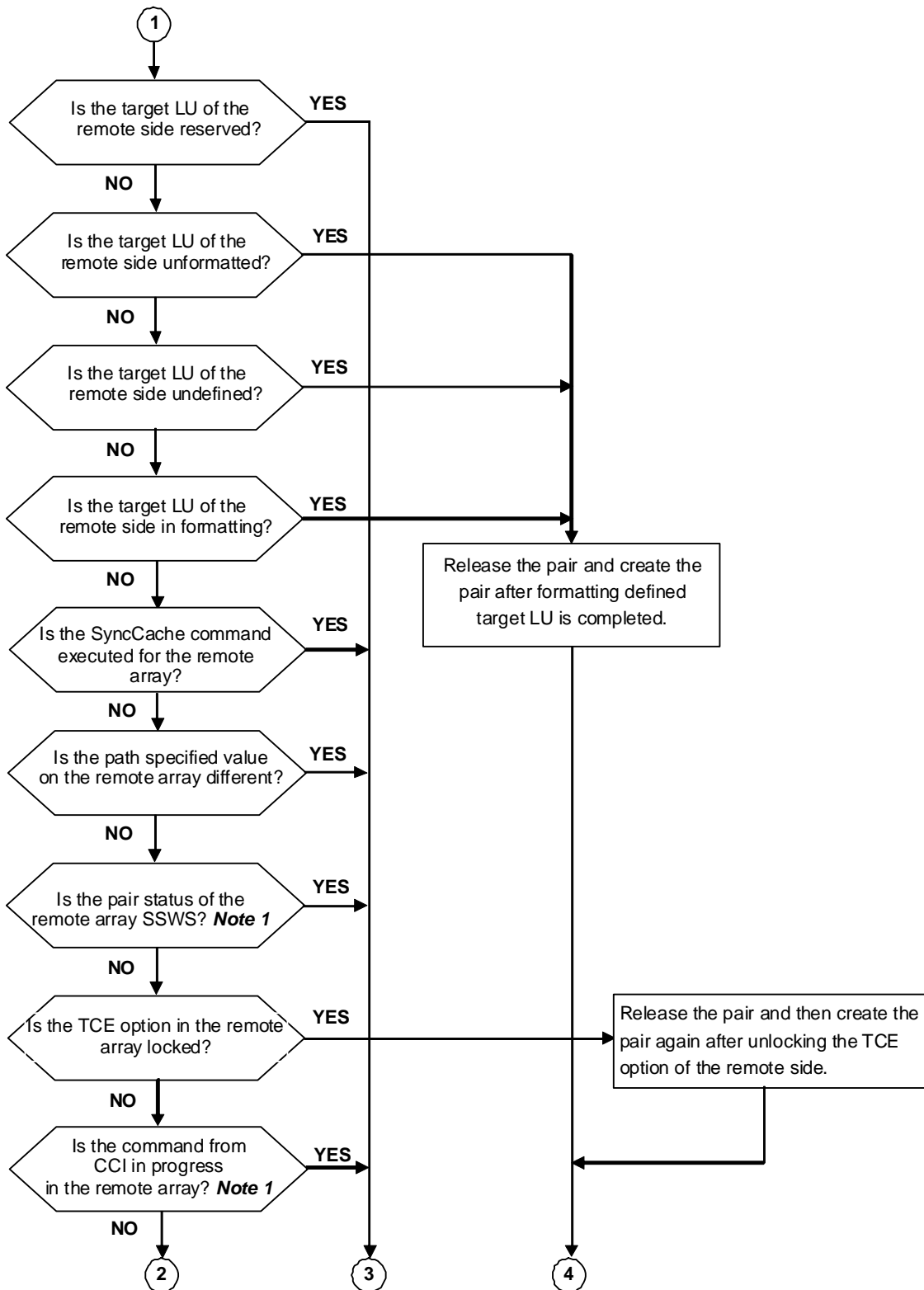

Figure 2-5: Pair Status Information Example Using TCE (continued)



NOTE: If a swap from S-VOL to P-VOL is in progress, the pairs cannot be resynchronized from P-VOL to S-VOL.

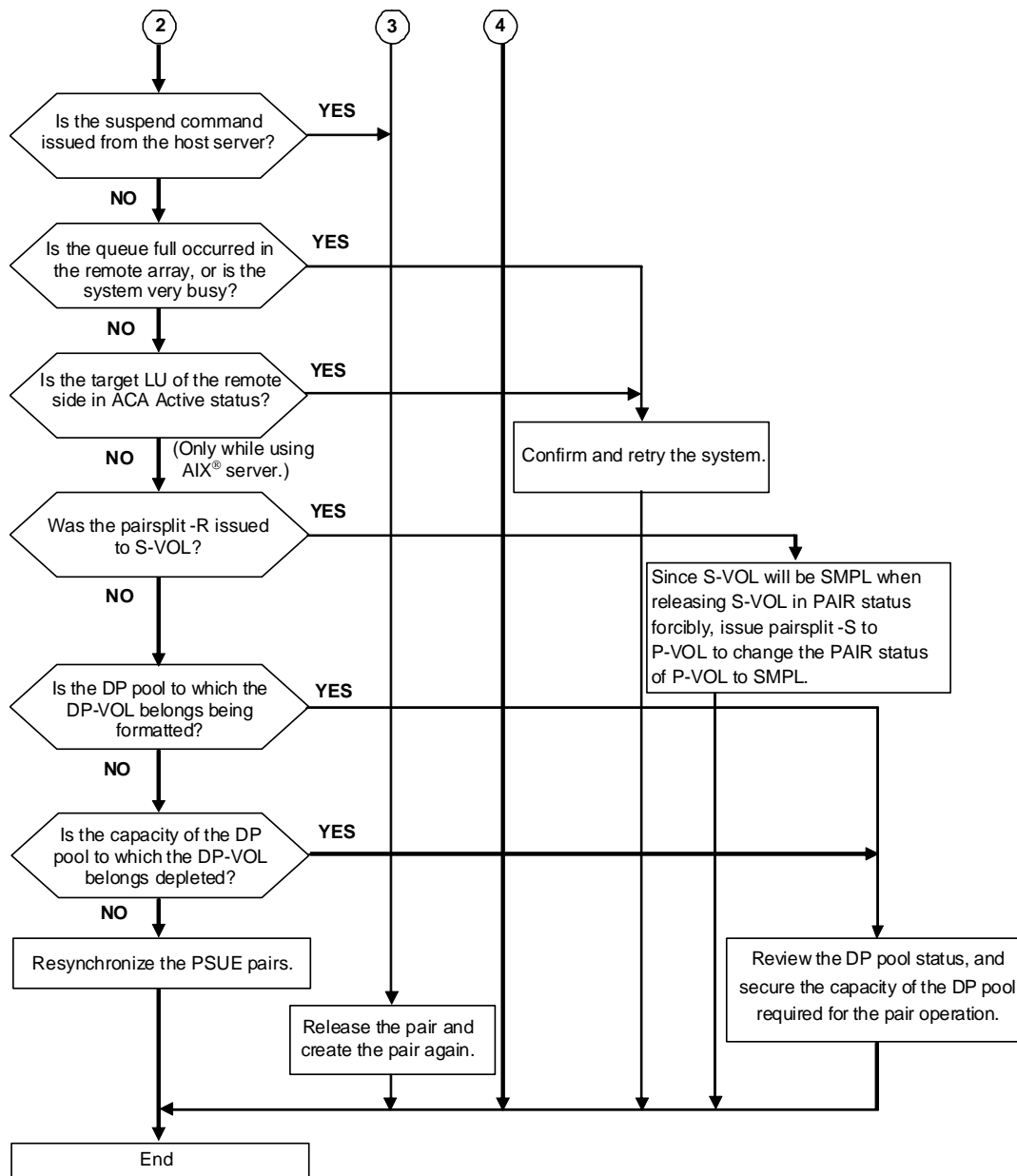

Figure 2-5: Pair Status Information Example Using TCE (continued)

When an error occurs in the Fibre route between arrays while operating TCE, the path is blocked. The system maintenance by the Hitachi personnel is necessary. [Figure 2-6 on page 2-15](#) shows the flow of the failure isolation while the path blockage occurred.

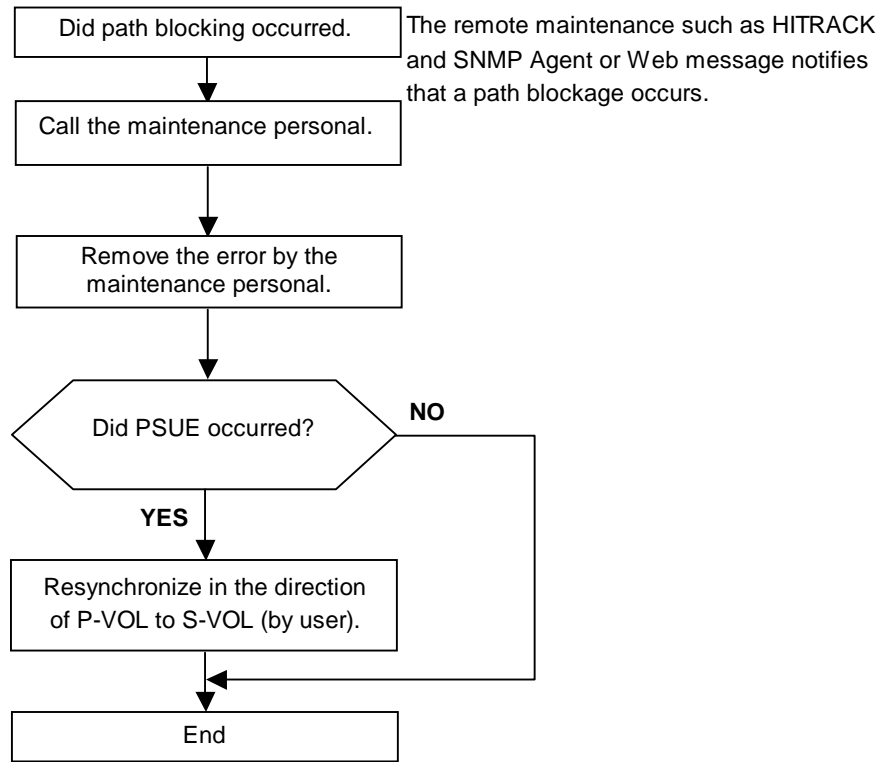

Figure 2-6: Path Status Information Example Using TCE

Table 2-4: TCE Operational Notes

Action	Action taken by whom
Confirm the message (syslog).	User
Checking the Information message sent from the Web built-in array (making sure of insufficiency of the data pool capacity)	User
Confirm whether PSUE is caused by you operation	User
Confirm the status of the array.	User
Call the maintenance personnel when the array malfunctions.	User
For other reasons, call the Hitachi support center.	User (only for users that are registered in order to receive a support)
Hardware maintenance (including path blockage).	Hitachi Customer Service
Reconfigure and recover the pair.	User

General troubleshooting

If you have a problem with the CCI software, first verify that the problem is not being caused by the UNIX or PC host hardware or software, and try restarting the host. [Table 2-5](#) provides operational notes and restrictions for CCI operations.

For maintenance of ShadowImage, SnapShot, TrueCopy, and TCE volumes, if a failure occurs, it is important to find the failure in the paired volumes, recover the volumes, and continue operation in the original system.

Table 2-5: CCI Operational Notes

Condition	Recommended Action
Startup or shutdown restrictions	<p>When the host starts, the primary volume host may update the secondary volume. The secondary volume must not be mounted automatically in the startup sequence. If the secondary volume is used by the LVM, the volume group of the LVM must be deactivated. The secondary volume must be mounted in the split state or in the simplex mode.</p> <p>When the host starts, the secondary volume can be activated without confirmation, once it can be guaranteed that the secondary volume has been PSUS (Read/Write enable) or it is in the SMPL state during the host shutdown sequence.</p>
Hot standby operations	<p>CCI commands cannot execute hot standby operations between the primary and secondary volumes. Use the takeover command intended for the HA configuration to execute the hot standby operation. In hot standby operation, two hosts are used, and the active (primary) and standby (secondary) host programs are run alternately in each host in case one host fails. Follow these precautions:</p> <p>Operation across volumes. Since each CCI command causes the host software to handle the volume by volume, a single volume should not be partitioned to prevent it from being used by selected hosts.</p> <p>Using LVM and paired volume together. When constructing the LVM on the paired volume in the mutual hot standby configuration, the LVM logical volumes must be constructed in units of volume to prevent the volumes from being mounted by the LVM.</p>
Coexistence of LVM mirror and TrueCopy	<p>When the LVM mirror and TrueCopy volumes are used together, the LVM mirror handles write errors and changes the volumes. Thus, the fence level of the volumes used by the LVM mirror must be set to data.</p>
Using paired volume in a single host	<p>When constructing a paired volume in a single host, it is necessary to activate two or more CCI instances. To activate two or more CCI instances, instance numbers must be assigned using the environmental variable HORCMINST. The HORCM and CCI commands must possess this environmental variable. A configuration definition file and a log directory must be set for each instance.</p>

Table 2-5: CCI Operational Notes (Continued)

Condition	Recommended Action
<p>Sharing volumes in a hot standby configuration</p>	<p>When a paired volume is used for the disk shared by the hosts in a hot standby configuration using HA software, use the primary volume as the shared disk and describe the corresponding hosts using the paired volume in the configuration definition file as shown below. In the HA configuration, if a CCI command issued by host C fails in host B (because host B has gone down, a command device IO_ERROR occurred, or both), host A is connected and command execution is retried.</p>  <p>The diagram illustrates a hot standby configuration. Three hosts, Host A, Host B, and Host C, are shown at the top. Host A and Host B are connected to a Primary volume, while Host C is connected to a Secondary volume. The Primary and Secondary volumes are connected as a Paired volume. The Primary volume is highlighted with a dashed box. The text 'HA configuration' is placed between Host A and Host B. Arrows indicate the connections from the hosts to the volumes.</p>
<p>Linkage with HA software</p>	<p>The HORCM must not be an object of the process monitored by the HA software (cluster manager), because HORCM should run at the same level as the cluster manager. Note: Do not use the pair volume for the cluster lock disk that HA software uses for election.</p>
<p>Maintenance</p>	<p>A HORCM restart is required if the array configuration is changed (for example, firmware exchange, cache memory install or uninstall).</p>
<p>Command device</p>	<p>Each CCI command is executed by issuing a command to the command device. This command is read or written from or into the specific block area of the command device. Therefore, you cannot use the command device. In addition, this device must not belong to an LVM volume group. For Windows systems, do not assign a drive letter to the command device to prevent utilization by general users.</p>
<p>Alternate path restrictions</p>	<p>If the P-VOL and S-VOL are on the same host, an alternate path from P-VOL to S-VOL cannot be used. Use of alternate path to a volume pair is limited to primary (secondary) volumes.</p>
<p>HORCM failure to activate</p>	<p>After a new system has been constructed, failure to activate HORCM may occur due to an improper environmental setting, configuration definition by you, or both. Refer to the HORCM activation log, and correct the settings.</p>

Table 2-5: CCI Operational Notes (Continued)

Condition	Recommended Action
Changing IO way of the command device for AIX	<p>CCI tries to use ioctl(DK_PASSTHRU) or SCSI_Path_thru as much as possible, if it fails, changes to RAW_IO follows conventional ways. Even so, CCI may encounter to AIX FCP driver which does not support the ioctl(DK_PASSTHRU) fully in the customer site. After this consideration, CCI also supports by defining either following environment variable or /HORCM/etc/USE_IOCTL file (size=0) that uses the RAW_IO forcibly.</p> <p>Example:</p> <pre>export USE_OLD_IOCTL=1 horcmstart.sh 10 HORCM/etc: -rw-r--r-- 1 root root 0 Nov 11 11:12 USE_OLD_IOCTL -r--r--r-- 1 root sys 32651 Nov 10 20:02 horcm.conf -r-xr--r-- 1 root sys 282713 Nov 10 20:02 horcmgr</pre>
Abnormal termination of command	<p>Refer to the command log file and HORCM log file to identify the cause of the error. If a command terminates abnormally because of a remote host failure, recover the host from the failure, then re-execute the command. If HORCM has shut down, restart HORCM. If an unrecoverable error occurs, obtain the log files and contact the Hitachi Support Center.</p>
Restriction for formatting the volumes	<p>Do not execute ShadowImage, SnapShot, TrueCopy, and TCE operations while formatting the volume. Formatting takes priority and ShadowImage, SnapShot, TrueCopy, and TCE operations will be suspended.</p>
The poll(10ms) parameter in the configuration definition file	<p>Always set the poll(10ms) parameter with a value more than or equal to 6,000. If you have created the configuration definition file using the mkconf command tool, set this value manually. If the value is set incorrectly, it may cause a conflict between the CCI and the array, which causes the internal process of the array to suspend temporary. The process may not proceed.</p>
Internal process conflict between the CCI and the array.	<p>When an internal process conflict occurs between the CCI and the array, the process of the array suspends temporarily. If the conflict continues, the internal process may not proceed. Therefore, when monitoring (polling) the status of the array (by creating a script using the CCI commands), set the information-display-based commands (for example, pairedisplay, raidscan, raidar, and raidqry) to be issued to more than or equal to a minute.</p>
Maximum supported capacity value of ShadowImage	<p>A maximum supported capacity value is changed with an equipment type and the mounted cache memory capacity. Please refer to each user's guide for details.</p>
Maximum supported capacity value of SnapShot	
Maximum supported capacity value of TrueCopy	
Maximum supported capacity value of TCE	
Restriction for TrueCopy and TCE	<p>Since S-VOL is reserved while using S-VOL of TrueCopy, the resources of MSCS, P-VOL cannot be copied to S-VOL. Therefore, S-VOL of TrueCopy must not be used as the resources of MSCS.</p>
	<p>Commands that change the status of pairs (paircreate, pairsplit, pairresync) of TrueCopy and TCE cannot be executed while the host restarting in TrueCopy and TCE environment. The command may end abnormally when executing a command while the host restarting.</p>

Error reporting

Table 2-6 shows HORCM system log messages and provides guidelines for resolving the error conditions.

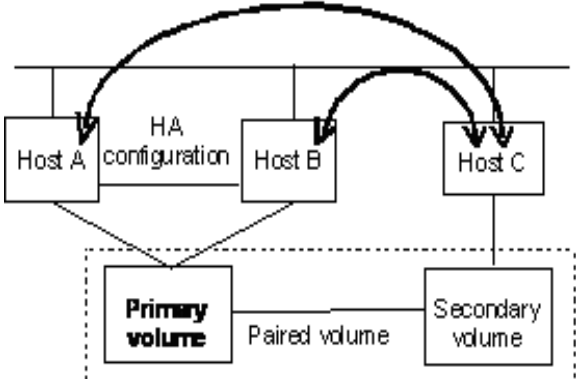
Table 2-7 on page 2-21 shows command error messages, their return values, and guidelines for resolving the error conditions.

Table 2-8 on page 2-27 and Table 2-9 on page 2-29 show the common error messages for each command.

Table 2-10 on page 2-30 shows lists the unique error messages.

Table 2-6: System Log Messages

Message ID	Condition	Cause	Recommended Action
HORCM_001	The HORCM log file cannot be opened.	The file cannot be created in the HORCM directory.	Create space on the disk where the root directory resides.
HORCM_002	The HORCM trace file cannot be opened.	The file cannot be created in the HORCM directory.	Create space on the disk where the root directory resides.
HORCM_003	The HORCM daemon process cannot create a child process due to an error.	HORCM daemon attempted to create more processes than the maximum allowable number.	Terminate unnecessary programs or daemon processes running simultaneously.
HORCM_004	HORCM assertion failed, resulting in a fatal internal error in the HORCM.	An internal error occurred which could not be identified by the HORCM.	Restart the system, collect all HORCM log and trace information, and call the Hitachi support center.
HORCM_005	The CCI software failed to create the end point for remote communication.	HORCM failed to create a socket, or an error exists in the HORCM configuration file (\$HORCM_CONF).	Refer to the HORCM startup log to identify the cause of the error and reset the parameters.
HORCM_006	HORCM memory allocation failed.	HORCM memory could not be secured.	Increase the system virtual memory, or close any unnecessary programs.
HORCM_007	An error exists in the HORCM setup file.	An error exists in the HORCM setup file.	Refer to the startup log and reset the parameters.
HORCM_008	HORCM configuration file parameters could not be read.	An error exists in the format or parameters of the HORCM configuration file (\$HORCM_CONF).	Refer to the HORCM startup log to identify the cause of the error.
HORCM_009	ShadowImage connection to the CCI software failed.	System devices are improperly connected, or an error exists in the HORCM configuration file.	Refer to the HORCM startup log to identify the cause of the error.

Table 2-6: System Log Messages (Continued)

Message ID	Condition	Cause	Recommended Action
HORCM_101	ShadowImage and the CCI software communication fails.	A system I/O error occurred or an error exists in the HORCM configuration file (\$HORCM_CONF).	Refer to the HORCM startup log to identify the cause of the error.
HORCM_102	The volume is suspended in code 0006.	The pair status was suspended due to code 0006.	<p>(For ShadowImage) Determine how the pair was suspended. If the pair was forcibly suspended, resynchronize the pair. If the pair was not suspended forcibly, the pair was suspended due to an error in the array. Collect all HORCM log and trace information, and call the Hitachi support center. After maintenance personnel have recovered the array, refer to Data recovery for PSUE using ShadowImage on page 2-31, Data recovery for PSUE using SnapShot on page 2-33, or Data recovery for PSUE using TrueCopy and TCE on page 2-34.</p> <p>Note: Unrecoverable indicates errors that cannot be recovered by executing the command again. Recoverable indicates errors that can be recovered by executing the command again. However, EX_EWSTOT of the horctakeover command is excluded. When the command completed with an error, the error is recorded in the CCI command log (\$HORCC_LOG) (see Chapter 3, Maintenance log and tracing functions).</p>

Table 2-7 shows command error messages, their return values, and guidelines for resolving the error conditions.

Table 2-7: Command Error Messages

Message ID	Error Message	Condition	Recommended Action	Return Value
EX_COMERR	Can't be communicated with HORC Manager	This command failed to communicate with the CCI software.	Verify that HORCM is running by using UNIX commands [ps – ef grep horcm].	255
EX_REQARG	Required Arg list	An option or arguments of an option are not sufficient.	Choose the correct option using the –h option.	254
EX_INVARG	Invalid argument	An option or arguments of an option are incorrect.	Choose the correct option using the –h option.	253
EX_UNWOPT	Unknown option	Designated an unknown option.	Choose the correct option using the –h option.	252
EX_ATTGOR	Can't be attached to HORC Manager	Could not connect with HORCM.	Verify that HORCM is running and that HORCMINST is set correctly. Note 1: For Windows Server, when a path detachment, which is caused by a controller detachment or interface failure, continues for longer than one minute, the command device may be unable to be recognized at the time when recovery from the path detachment is made. To make the recovery, execute the “re-scanning of the disks” of Windows. When Windows cannot access the command device although HORCM becomes able to recognize the command device, restart HORCM.	251
EX_ATTDBG	Can't be attached to a Debug layer	Failed to communicate with HORCM, or cannot make a log directory file.	Verify that HORCM is running by using UNIX commands [ps – ef grep horcm].	250
EX_INVNAM	Invalid name of option	The name specified in an argument of an option is not appropriate.	Choose the correct option using the –h option.	249
EX_OPTINV	A specified option is invalid	Detected contradiction in information that RAID reported.	Call the Hitachi Support Center.	248
EX_ENOENT	No such device or group	The designated device or group name does not exist in the configuration file.	Verify the device or group name and add it to the configuration file of the remote and local hosts.	247

Table 2-7: Command Error Messages (Continued)

Message ID	Error Message	Condition	Recommended Action	Return Value
EX_ENODEV	No such device	The designated device name does not exist in the configuration file.	Verify the device name and add it to the configuration file of the remote and local hosts.	246
EX_ENOUNT	No such RAID unit	The designated RAID unit ID does not exist in the configuration file.	Verify the RAID unit ID and add it to the configuration file of the remote and local hosts.	219
EX_ENQSER	Unmatched Serial# vs RAID unitID	The group designated by ShadowImage/ SnapShot paircreate does not have the same RAID unit, or the unitID is not identical to the unit ID in the same RAID serial#.	Verify the serial# (serial number) using the pairdisplay command, or confirm serial# of the RAID using the raidqry -r command	218
EX_ENOMEM	Not enough core	Insufficient memory exists.	Increase the virtual memory capacity of the system, or close any unnecessary programs and daemon processes.	245
EX_ERANGE	Result too large	Tried to use arguments for an option beyond the maximum allowed, or a result beyond the maximum was created.	Refer to the error message, and designate an appropriate value.	244
EX_ENAMLG	File name too long	Undefined error.	-	243
EX_ENORMT	No remote host alive for remote commands or Remote Raid Manager might be blocked(sleeping) on an existing I/O	A timeout occurred on remote communication, and HORC Manager failed to re-execute.	Confirm that the HORC Manager in the remote host is running, and then increase the value of the timeout in the configuration file. If you want to execute within the local host, execute the command that supports the local option (-l).	242
EX_INVMOD	Invalid RAID command mode	Detected a contradiction for a command.	Collect all HORCM log information, and call the Hitachi Support Center.	241
EX_INVCMD	Invalid RAID command	Detected a command error.	Collect all HORCM log information, and call the Hitachi Support Center.	240

Table 2-7: Command Error Messages (Continued)

Message ID	Error Message	Condition	Recommended Action	Return Value
EX_ENOGRP	No such group	The designated device or group name does not exist in the configuration file, or the network address for remote communication does not exist.	Verify the device or group name and add it to the configuration file of the remote and local hosts.	239
EX_UNWCOD	Unknown function code	Detected a command error.	Collect all HORCM log information, and call the Hitachi Support Center.	238
EX_CMDIOE	Control command I/O error	A read/write to the command device failed with an I/O error.	Refer to the host syslog file, and investigate the cause of the error. If the problem persists, collect all HORCM log information, and call the Hitachi Support Center.	237
EX_CMDRJE	An order to the control/command device was rejected	The request to the command device failed or was rejected. Note: This error code is sometimes caused by the operating system and reported as EX_CMDIOE instead of EX_CMDRJE (see next row).	Investigate the detailed factor of the error referring to the information on the syslog of the host or the HORCM log (refer to How to read detailed error log codes on page 3-5). Confirm the following items, and if the problem persists, collect all HORCM log information, and call the Hitachi Support Center. Verify ShadowImage, SnapShot, TrueCopy, and TCE functions are installed. Verify that the target volume is available.	221
EX_CMDIOE	Control command I/O error, or rejected	A read/write to the command device failed with an I/O error or was rejected.	Investigate the detailed factor of the error referring to the information on the syslog of the host or the HORCM log (refer to section How to read detailed error log codes on page 3-5). If the cause is "Illegal Request (0x05)" Sense Key, please confirm the following items. If the problem persists, collect all HORCM log information, and call the Hitachi Support Center. Verify ShadowImage and SnapShot functions are installed. Verify that the target volume is available.	237
EX_ENQVOL	Unmatched volume status within the group	The volume attribute or the fence level within a group is not identical.	Verify status using the pairedisplay command. Make sure all volumes in the group have the same fence level and volume attributes.	236

Table 2-7: Command Error Messages (Continued)

Message ID	Error Message	Condition	Recommended Action	Return Value
EX_EVOLCE	Pair Volume combination error	Combination of a volume is unsuitable between the remote and local host.	Verify volume status using the pairdisplay command, and change the combination of volumes properly.	235
EX_EWSUSE	Pair suspended at WAIT state	Detected a suspended status (PSUE) for the paired volume, before it achieves the designated status.	Determine how the pair was suspended. If the pair was forcibly suspended, resynchronize the pair. If the pair was not suspended forcibly, the pair was suspended due to an error in the array. Collect all HORCM log and trace information, and call the Hitachi support center. After maintenance personnel have recovered the array, refer to section Data recovery for PSUE using ShadowImage on page 2-31 . Note: Unrecoverable indicates errors that cannot be recovered by executing the command again. Recoverable indicates errors that can be recovered by executing the command again. However, EX_EWSTOT of the horctakeover command is excluded. When the command completed with an error, the error is recorded in the CCI command log (\$HORCC_LOG) (see Chapter 3, Maintenance log and tracing functions).	234
EX_EWSTOT	Timeout waiting for specified status	Detected a timeout before it achieved the designated status.	Increase the value of the timeout using the -t option.	233
EX_EWSLTO	Timeout waiting for specified status on the local host	Timeout error because the remote did not note expected status.	Verify that HORC Manager on the remote host is running.	232
EX_ESTMON	HORCM Monitor stopped	HORC Manager monitoring was refused.	Verify the value of "poll" in the configuration file.	231
EX_UNWCMD	Unknown command	An unknown command was attempted.	Verify the command name.	230
EX_INCSTG	Inconsistent status in group	The pair status of a volume within a group is not identical to the status of the other volumes in the group.	Verify the pair status using the pairdisplay command.	229

Table 2-7: Command Error Messages (Continued)

Message ID	Error Message	Condition	Recommended Action	Return Value
EX_INVSTP	Invalid pair status	The pair status of the target volume is not appropriate.	Verify the pair status using the pairdisplay command.	228
EX_INVVOL	Invalid volume status	The volume status of the target volume is not appropriate.	Verify the pair status using the pairdisplay -I command.	222
EX_INVMUN	Invalid mu# with HORC or HOMRCF	The MU# of the volume to be operated is not appropriate.	Verify the MU# for the specified group using the pairdisplay command. Also verify whether the command execution environment is set as HORCC_MRCF 1.	220
EX_ENLDEV	No such LDEV within the RAID	A device defined in the configuration file does not have a mapping to a real LUN and Target ID within the RAID.	Please confirm that the Port, Target ID, LUN is defined correctly under HORCM_DEV in the configuration file.	227
EX_INVRCD	Invalid return code	Wrong return code.	Collect all HORCM log information, and call the Hitachi Support Center.	226
EX_VOLCUR	S-Vol currency error	Currency check error for S-VOL. Cannot guarantee identical data on S-VOL.	Check the volume list to see if an operation was directed to the wrong S-VOL.	225
EX_VOLCUE	Local Volumecurrency error	The volume specified with the SVOL-takeover command is not the same as the P-VOL.	Verify the pair status of the local volume.	224
EX_VOLCRE	Local and Remote Volumecurrency error	The combination of the volumes specified with Swap-takeover is unsuitable.	Verify the pair status of remote and local volumes using the pairdisplay command.	223
EX_UNWERR	Unknown Error code	Wrong error code.	Collect all HORCM log information, and call the Hitachi Support Center.	--
EX_ENOCTG	Not enough CTgroups in RAID	CTGID could not be registered due to being beyond the max number of CT groups (0-127) for a volume. Or the cycle time that has been set for the array is less than the minimum value to be set.	Choose an existing CTGID (use pairvolchk to display CTGIDs). Use the '-f <CTGID>' option of the paircreate command to force the pair into a pre-existing CTGID. Or set an appropriate value to the cycle time.	217

Table 2-7: Command Error Messages (Continued)

Message ID	Error Message	Condition	Recommended Action	Return Value
EX_EXTCTG	Extended CT group across RAIDs	A volume is defined in the configuration file (HORCM_CONF) as a group that extends across arrays.	Please confirm the serial # of the volumes by using the pairdisplay command to verify that the CT group is contained completely within one RAID array.	216
EX_ENXCTG	No CTgroups left for OPEN Vol use	An available CT group for volume does not exist.	-	215
EX_ENQCTG	Unmatched CTGID within the group	The CT group references within a group do not have an identical CTGID.	Please confirm the CTGID using the pairvolchk command and confirm that group references within the configuration file (HORCM_CONF) refer to the same CT group.	214
EX_ENPERM	Permission denied with the LDEV	The device described in the configuration definition file is not permitted for pair operation.	Execute the pairdisplay command or the raidscan – use the verify command to verify that the device is permitted for the pair operation.	213
EX_ENQSIZ	Unmatched volume size for pairing	1. The number or the size of the volume between the local and remote volume is not appropriate. 2. The product ID on the local array does not correspond with the product ID on the remote array.	1. Check the volume size of the target pair using raidscan –f option, and then set the same size for local and remote volumes for the target pair. 2. Set the identical product ID in the local and remote array.	212
EX_ERPERM	Permission denied with the RAID	The volume on the configuration file is a volume that is not permitted to operate a pair in the array.	Set HITACHI for the vendor ID.	211
EX_ESVOLD	SVOL denied due to be disabling	It is inhibited to assign the specified volume to be paired to an S-VOL.	Check whether the volume to be paired is not inhibited to be assigned to an S-VOL using the inquired –fl or raidvchkdsp –v gflag command.	209
EX_ENOSUP	Micro code not supported	The specified command option is not supported by the firmware of the array.	Make sure of a version of the firmware of the array using the raidgry –l command.	210

Table 2-7: Command Error Messages (Continued)

Message ID	Error Message	Condition	Recommended Action	Return Value
EX_EPRORT	Mode changes denied due to retention time	It is inhibited to change a mode of the specified volume during the term of protection.	Make sure of the term of protection for the object volume using the raidvchkdsp -v gflag command.	208

Table 2-8 shows common error messages for the horctakeover, paircurchk, paircreate, pairsplit, pairresync, pairevtwait, pairvolchk, pairsyncwait, and pairdisplay commands.

Table 2-9 on page 2-29 shows common error messages for the raidscan, raidar, raidqry, and horcctl commands.

Table 2-8: Common Error Messages for Horctakeover, Paircurchk, Paircreate, Pairsplit, Pairresync, Pairevtwait, Pairvolchk, Pairsyncwait, and Pairdisplay Commands

Type	Message ID	Error Message	Return Value
Syntax for Argument Unrecoverable	EX_REQARG	Required Arg list	254
	EX_INVARG	Invalid argument	253
	EX_INVNAM	Invalid name of option	249
	EX_UNWOPT	Unknown option	252
	EX_UNWCOD	Unknown function code	238
	EX_UNWCMD	Unknown command	230
	EX_ERANGE	Result too large	244
	EX_ENAMLG	File name too long	243
	EX_INVRCD	Invalid return code	226
Configuration Unrecoverable	EX_ENOGRP	No such group	239
	EX_ENOENT	No such device or group	247
	EX_ENODEV	No such device	246
	EX_ENLDEV	No such LDEV within the RAID	227
	EX_ENOUNT	No such RAID unit	219
	EX_INVMUN	Invalid mu# with HORC or HOMRCF	220
	EX_ENQSER	Unmatched Serial# vs RAID unitID	218
	EX_EXTCTG	Extended CTgroup across RAIDs	216
	EX_ENOCTG	Unmatched CTGID within the group	214
	EX_ENPERM	Permission denied with the LDEV	213
EX_ERPERM	Permission denied with the RAID	211	

Table 2-8: Common Error Messages for Horctakeover, Paircurchk, Paircreate, Pairsplit, Pairresync, Pairevtwait, Pairvolchk, Pairsyncwait, and Pairedisplay Commands (Continued)

Type	Message ID	Error Message	Return Value
Command I/O to RAID Recoverable	EX_CMDRJE	An order to the control/command device was rejected	221
	EX_CMDIOE	Control command I/O error Control command I/O error, or rejected	237
	EX_OPTINV	A specified option is invalid	248
	EX_INVMOD	Invalid RAID command mode	241
	EX_INVCMD	Invalid RAID command	240
Communication for HORCM Recoverable	EX_ATTHOR	Can't be attached to HORC Manager	251
	EX_ATTDBG	Can't be attached to a Debug layer	250
	EX_COMERR	Can't be communicated with HORC Manager	255
	EX_ENORMT	No remote host alive for remote commands or Remote Raid Manager might be blocked (sleeping) on an existing I/O.	242
Resource Unrecoverable	EX_ENOMEM	Not enough core	245



NOTE: Unrecoverable indicates errors that cannot be recovered by executing the command again. Recoverable indicates errors that can be recovered by executing the command again.

Table 2-9: Common Error Messages for Raidsan, Raidar, Raidqry, and Horcctl Commands

Type	Message ID	Error Message	Return Value
Syntax for Argument Unrecoverable	EX_REQARG	Required Arg list	254
	EX_INVARG	Invalid argument	253
	EX_INVNAM	Invalid name of option	249
	EX_UNWOPT	Unknown option	252
	EX_UNWCOD	Unknown function code	238
	EX_UNWCMD	Unknown command	230
	EX_ERANGE	Result too large	244
	EX_ENAMLG	File name too long	243
	EX_INVRCD	Invalid return code	226
Configuration Unrecoverable	EX_ENLDEV	No such LDEV within the RAID	227
	EX_ENOUNT	No such RAID unit	219
	EX_INVNUM	Invalid mu# with HORC or HOMRCF	220
	EX_ERPERM	Permission denied with the RAID	211
	EX_ENOSUP	Micro code not supported	210
Command I/O to RAID Recoverable*	EX_CMDIOE	Control command I/O error Control command I/O error, or rejected	237
	EX_OPTINV	A specified option is invalid	248
	EX_INVMOD	Invalid RAID command mode	241
	EX_INVCMD	Invalid RAID command	240
Communication for HORCM Recoverable	EX_ATTHOR	Can't be attached to HORC Manager	251
	EX_ATTDBG	Can't be attached to a Debug layer	250
	EX_COMERR	Can't be communicated with HORC Manager	255
Resource Unrecoverable	EX_ENOMEM	Not enough core	245



NOTE: Unrecoverable indicates errors that cannot be recovered by executing the command again. Recoverable indicates errors that can be recovered by executing the command again.

The following list includes unique error messages for the horctakeover, paircurchk, paircreate, pairsplit, pairresync, pairevtwait, pairvolchk, pairsyncwait, and raidvchkset commands.

Table 2-10: Unique Error Message for Horctakeover, Paircurchk, Paircreate, Pairsplit, Pairresync, Pairevtwait, Pairvolchk, Pairsyncwait, and Raidvchkset Commands

Command	Type	Message ID	Error Message	Return Value	
paircreate, pairsplit, pairresync, pairevtwait, pairvolchk, horctakeover	Volume status Unrecoverable	EX_ENQVOL	Unmatched volume status within the group	236	
paircreate, pairsplit, pairresync, pairevtwait, horctakeover		EX_INCSTG	Inconsistent status in group	229	
paircreate, pairsplit, pairresync, pairevtwait, pairsyncwait		EX_INVVOL	Invalid volume status	222	
pairsplit, pairevtwait, pairvolchk, horctakeover		EX_EVOLCE	Pair Volume combination error	235	
paircreate, pairsplit, pairresync		EX_INVSTP	Invalid pair status	228	
paircurchk, horctakeover		EX_VOLCUR	S-VOL currency error	225	
horctakeover		EX_VOLCUE	Local Volume currency error	224	
horctakeover		EX_VOLCRE	Local and Remote Volume currency error	223	
pairsplit, pairevtwait		EX_EWSUSE	Pair suspended at WAIT state	234	
paircreate		EX_ENQSIZ	Unmatched volume size for pairing	212	
		EX_EWSTOT	SVOL denied due to be disabling	209	
raidvchkset		EX_EWSLTO	Mode changes denied due to retention time	208	
pairevtwait, horctakeover		Timer Recoverable	EX_EWSTOT	Timeout waiting for specified status	233
pairevtwait			EX_EWSLTO	Timeout waiting for specified status on the local host	232
paircreate	Resource Unrecoverable	EX_ENOCTG	Not enough CTgroups in RAID	217	
paircreate		EX_ENXCTG	No CTgroups left for OPEN Vol use.	215	



NOTE: Unrecoverable indicates errors that cannot be recovered by executing the command again. Recoverable indicates errors that can be recovered by executing the command again. However, EX_EWSTOT of the horctakeover command is excluded. When the command completed with an error, the error is recorded in the CCI command log (\$HORCC_LOG) (see [Maintenance Logs and Tracing Functions](#)).

Data recovery for PSUE using ShadowImage

When a pair was suspended (PSUE) due to a failure in the array, collect the CCI system log files and call the Hitachi maintenance personnel (see [Pair-splitting guidelines, on page 2-32](#)).

Maintenance personnel will remove the source of error in the array. After the source of the error has been removed, the system administrator must recover the pair using the CCI commands.

Recovering the pair

Make sure that the system administrator has verified that the PSUE occurred while resynchronizing from S-VOL to P-VOL (`pairresync -restore`). [Table 2-11](#) shows data assurance and the method for recovering the pair.

Table 2-11: Data Assurance and Recovery Methods

State before PSUE	Data Assurance	Action to be taken after PSUE
Other than RCPY	P-VOL: Assured S-VOL: Not assured	Resynchronize (<code>pairresync</code>) in the direction of P-VOL to S-VOL. Note that the pair may have been split due to the drive's double-malfunction in either or both volumes. In such case, confirm that the data exists in the P-VOL, and then create a pair (<code>paircreate</code>).
RCPY	P-VOL: Not assured S-VOL: Not assured	Split the pair (<code>pairsplit -S</code>), restore the backup data to P-VOL, and then create a pair (<code>paircreate</code>). Note that the pair may have been split due to the drive's double-malfunction in either or both volumes. In such case, confirm that the backup data restoration has been completed to the P-VOL, and then create a pair.

Internal LUN, device recognized by the host

To verify the correspondence of the internal LU number in the array and the device name recognized by the host, use the `inqraid` command tool or the `raidsan` command. The following example illustrates using the `inqraid` command tool in the HP-UX system.

```
# ls /dev/rdisk/* | ./inqraid -find
Group PairVol (L/R) (Port#,TID,LU-M), Seq#,LDEV#, P/S, Status, Seq#, P-LDEV# M
horcl dev00(L) (CL2-A, 0, 0-0) 85006145 0 S-VOL SSUS, ----- 9 -
->/dev/rdisk/c23t0d0
Group PairVol (L/R) (Port#,TID,LU-M), Seq#,LDEV#, P/S, Status, Seq#, P-LDEV# M
horcl dev10(L) (CL2-A, 2, 3-0) 85006145 3 S-VOL SSUS, ----- 6 -
> Hraddisk3
```

Figure 2-7: Correspondence between Internal LU and Device Recognized by Host

For details on the `inqraid` command tool, refer to [Inqraid command tool, on page 1-85](#). For details on `raidsan` command, refer to [Raidsan command, on page 1-51](#).

Pair-splitting guidelines

When the host cannot recognize an LU while the protection function is ON, the following message is displayed and operations to the pair of the unrecognized LU cannot be performed.

```
[EX_ENPERM] Permission denied with the LDEV
```

Figure 2-8: Message Displayed when Host Cannot Recognize an LU

Issue the `pairdisplay` command and verify the pair status. An example is shown below.

```
C:\horcm\etc>pairdisplay -g vg01 -fc
Group PairVol (L/R) (Port#,TID, LU-M) ,Seq#,LDEV#.P/S,Status, % ,P-LDEV# M
vg01 oradb1(L) (CL1-A , 1, 1-0) 85009876 1. P-VOL PSUE, 0 2 -
vg01 oradb1(R) (CL1-A , 1, 2-0) 85009876 ****. -----,----- -
vg01 oradb2(L) (CL1-A , 1, 3-0) 85009876 3. P-VOL PSUE, 0 2 -
vg01 oradb2(R) (CL1-A , 1, 4-0) 85009876 ****. -----,----- -
vg01 oradb3(L) (CL1-A , 1, 5-0) 85009876 5. P-VOL PSUE, 0 2 -
vg01 oradb3(R) (CL1-A , 1, 6-0) 85009876 ****. -----,----- -
```

LUs not recognized by the host.

Figure 2-9: Pair Status Verification

After the pair status is verified, turn the protection function OFF, restart HORCM, and then split the pair (to turn the protection function OFF, delete the environment variable `$HORCMPROMOD`). For details on the environment variable, see [Environment variables, on page 1-3](#).

After splitting the pair and when the drive maintenance is done by the maintenance personnel, restore the backup data, make the host recognize the LU, and create the pair. And then turn the protection function ON and start HORCM.

Data recovery for PSUE using SnapShot

When a pair was suspended (PSUE) due to a failure in the array, collect the CCI system log files and then call the Hitachi maintenance personnel. The maintenance personnel will remove the error cause of the array. After the error cause has been removed, the system administrator must recover the pair using the CCI commands.

Recovering the pair

The concrete pair recovery using SnapShot is that pair is split (with `pairsplit -S`) once and then create again (with `paircreate`). Recover the pair following the detailed recovery procedure shown in [Figure 2-2](#) on [page 2-5](#).

Make sure that the system administrator has verified that the PSUE occurred while restoring from V-VOL to P-VOL (`pairresync -restore`). [Table 2-12](#) shows data assurance and the method for recovering the pair.

Table 2-12: Data Assurance and Recovery Methods

State before PSUE	Data Assurance	Action to be taken after PSUE
Other than COPY(RS-R)	P-VOL: Assured V-VOL: Not assured	Split the pair (<code>pairsplit -S</code>), and then create a pair (<code>paircreate</code>) again. Note that the pair may have been split due to the drive's double-malfunction in either or both volumes. In such case, confirm that the data exists in the P-VOL, and then create a pair (<code>paircreate</code>). Incidentally, the V-VOL data generated is not the one invalidated previously but the P-VOL data at the time when the pair was newly formed.
COPY(RS-R)	P-VOL: Not assured V-VOL: Not assured	Split the pair (<code>pairsplit -S</code>), restore the backup data to P-VOL, and then create a pair (<code>paircreate</code>). Note that the pair may have been split due to the drive's double-malfunction in either or both volumes. In such case, confirm that the backup data restoration has been completed to the P-VOL, and then create a pair. Incidentally, the V-VOL data generated is not the one invalidated previously but the P-VOL data at the time when the pair was newly formed.

Data recovery for PSUE using TrueCopy and TCE

When a pair was suspended (PSUE) due to a failure in the array, collect the CCI system log files and then call the Hitachi maintenance personnel. The maintenance personnel will remove the error cause of the array. After the error cause has been removed, the system administrator must recover the pair using the CCI commands.

Recovering the pair

Resynchronization in the direction of P-VOL to S-VOL enables to recover a TrueCopy or TCE pair. (The resynchronization cannot be performed in the direction of S-VOL to P-VOL.) However, when a pair was suspended (status = PSUE) without a failure in the system, once release the pair and create the pair again. Please recover the pair following the procedure in [Figure 2-3 on page 2-7](#) for TrueCopy or [Figure 2-5 on page 2-12](#) for TCE.



NOTE: In the case of TCE, the resynchronization of the S-VOL with the P-VOL is required when the P-VOL status is changed to PFUS because the amount of the data in the primary data pool exceeds the capacity allowed to be used or the S-VOL status is changed to PSUS(N) as well as the P-VOL status is changed to PSUE. The PSUS(N) means the Read/Write operation cannot be performed; and it is a status in which the S-VOL data is not restored even when the SVOL-Takeover operation is performed.

Maintenance log and tracing functions

This chapter contains the following sections:

- ❑ [Log files](#)
- ❑ [Trace files](#)
- ❑ [How to read detailed error log codes](#)
- ❑ [Logging of a command](#)

Log files

The CCI software (HORCM) and ShadowImage, SnapShot, TrueCopy or TCE commands maintain internal logs and traces which can be used to identify the source of errors and keep records of the status transition history of paired volumes. [Figure 3-1](#) displays the CCI logs and traces.

HORCM logs are classified into start-up logs and execution logs. The start-up logs contain data on errors that occur before the HORCM is ready to provide services. Thus, if the HORCM fails to start up due to improper environment settings, refer to the start-up logs to resolve the problem. The HORCM execution logs (error log, trace, and core files) contain data on errors that are caused by software or hardware problems. These logs contain internal error data, which does not apply to any user settings; therefore, users do not need to refer to the HORCM execution logs. When an error occurs during the execution of a command, data on the error is collected in the command log file. Users may refer to the command log file if a command execution error occurs.

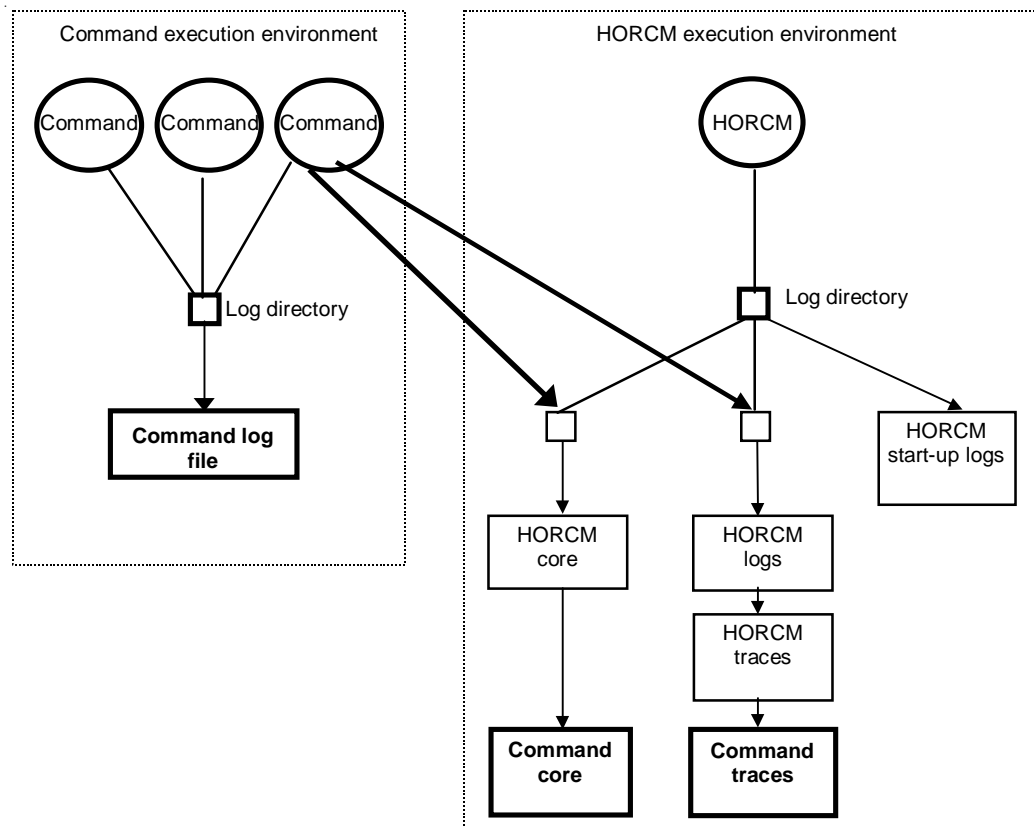

Figure 3-1: Logs and Traces

The start-up log, error log, trace, and core files are stored as shown in [Table 3-1](#). Specify the directories for the HORCM and command log files using the HORCM_LOG and HORCC_LOG environmental variables as shown in [Table 3-2](#). If it is not possible to create the log files, or if an error occurs before the log files are created, the error logs are output in the system log file. If the HORCM activation fails, the system administrator should check the system log file, identify the error cause, and take the proper action. For details on message output to the system log file and the recommended

actions for resolving the error conditions, see [Chapter 2, Troubleshooting](#). The system log file for UNIX-based systems is the syslog file. The system log file for Windows-based systems is the event log file.

Table 3-1: Log Files

File	UNIX-based Systems	Windows-based Systems
Start-up log	HORCM start-up log: \$HORCM_LOG/horcm_HOST.log Command log: \$HORCC_LOG/horcc_HOST.log	HORCM start-up log: \$HORCM_LOG\horcm_HOST_log.txt Command log: \$HORCC_LOG\horcc_HOST_log.txt
Error log	HORCM error log: \$HORCM_LOG/horcmlog_HOST/horcm.log	HORCM error log: \$HORCM_LOG\horcmlog_HOST\horcm_log.txt
Trace	HORCM trace: \$HORCM_LOG/horcmlog_HOST/horcm_PID.trc Command trace: \$HORCM_LOG/horcmlog_HOST/horcc_PID.trc	HORCM trace: \$HORCM_LOG\horcmlog_HOST\horcm_PID_trc.txt Command trace: \$HORCM_LOG\horcmlog_HOST\horcc_PID_trc.txt
Core	HORCM core: \$HORCM_LOG/core_HOST_PID/core Command core: \$HORCM_LOG/core_HOST_PID/core	HORCM core: \$HORCM_LOG\core_HOST_PID\core Command core: \$HORCM_LOG\core_HOST_PID\core



NOTE: Host denotes the host name of the corresponding machine. PID denotes the process ID of that machine. The location of the directory that contains the log file depends on you's command execution environment and the HORCM execution environment. The command trace file and core file reside together under the directory specified in the HORCM execution environment. A directory specified using the environmental variable HORCM_LOG is used as the log directory in the HORCM execution environment. If no directory is specified, directory **/tmp** is used. A directory specified using the environmental variable HORCC_LOG is used as the log directory in the command execution environment. If no directory is specified, the directory **/HORCM/log*** is used (* = instance number). A nonexistent directory may be specified as a log directory using the environmental variable.

Table 3-2: Log Directories

Directory Name	Definition
\$HORCM LOG	A directory specified using the environmental variable HORCM_LOG . The HORCM log file, trace file, and core file as well as the command trace file and core file are stored in this directory. If no environmental variable is specified, /HORCM/log/curlog is used.
\$HORCC LOG	A directory specified using the environmental variable HORCC_LOG . The command log file is stored in this directory. If no environmental variable is specified, the directory /HORCM/log* is used (* is the instance number). While the HORCM is running, the log files are stored in the \$HORCM_LOG directory shown in (a). When the HORCM starts up, the log files created in the operation are stored automatically in the \$HORCM_LOGS directory shown in (b). a. HORCM log file directory in operation \$HORCM_LOG = /HORCM/log*/curlog (* is instance number) b. HORCM log file directory for automatic storing \$HORCM_LOGS = /HORCM/log*/tmplog (* is instance number)

Trace files

The command trace file is used for maintenance [Chapter 2, Troubleshooting](#) maintenance. It is not created normally. If the source of an error cannot be identified by means of the log file, the environmental variables or trace control commands with trace control parameters are issued to start tracing and the trace file is created. The trace control parameters consist of the trace level, file size, mode, and so on. Increasing the trace level enables more detailed tracing. Tracing is made in wraparound within the range of the file size. The HORCM creates the trace file according to the trace level specified in the HORCM start-up shell script set to activate the HORCM.

Trace control command

The trace control command (one of the HORCM control commands) sets or changes the trace control parameters. This command is used for [Chapter 2, Troubleshooting](#) and maintenance. If no trace control parameters can be specified using the environmental variables in your command execution environment, it is possible to change the trace control parameters into the global parameters using this command. [Table 3-3](#) lists and describes the parameters of the trace control command.

Table 3-3: Trace Command Parameters

Parameter	Function
Trace level parameter	Specifies the trace level, range = 0 to 15.
Trace size parameter	Specifies the trace file size in kB.
Trace mode parameter	Specifies the buffer mode or non-buffer mode for writing data in the trace file.
Trace type parameter	Specifies the trace type defined internally.
Trace change instruction	Specifies either the command or the HORCM (CCI instance) for which the trace control parameters are changed.

How to read detailed error log codes

You can obtain detailed information on the error from an error message (EX_CMDIOE and/or EX_CMDRJE) collected in a command log by referring to a detailed code, sense code, and sub-code. Each code can be collected from an error message or error log displayed at the time of command execution. Figure 3-2 shows an example of each code displayed in the error message. See Refer to [Figure 3-4 on page 3-6](#), [Figure 3-6 on page 3-7](#), or [Figure 3-8 on page 3-8](#) for each code displayed in the error log.

```
C:\HORCM\etc>paircreate -g si -d si-3 -vl -c 8
paircreate: [EX_CMDRJE] An order to the control/command device was rejected
Refer to the command log(C:\HORCM\log0\horcc_ylog6quetvf70ri_log.txt) for details.
It was rejected due to SKEY=0x05, ASC=0x96, ASCO=0x1C, SSB=0x8400, 0x00D0 on
Serial#(87000018)
```

Sense code(961C)
Sub-code(84)
Detailed code(00D0)

Figure 3-2: Error Message Example

See [Table 3-4](#) for detailed information about the error indicated by the collected detailed code, sense code and sub-code

A command log is output to the side of an instance that has executed a command. An error log is output to an instance on the primary volume side or the secondary volume side depending on the type of the command irrespective of whether the instance that has executed the command is on the primary volume side or the secondary volume side. When an error occurs during the execution of the command, examine the error cause by looking at the error logs of both local instance (an instance that has executed the command) and the remote instance. Examples of the decisions, to which of the local instance and the remote instance the error log corresponding to the command log is output, are shown in [Table 3-4](#).

Table 3-4: Command Log and Error Log Destination

Command	Command Log	Error Log
paircreate -vr	Local instance	Remote instance
pairresync (Issuing the command from an instance on the primary volume side)	Local instance	Local instance
pairresync (Issuing the command from an instance on the secondary volume side)	Local instance	Remote instance

The error log corresponding to the command log can be found out using a time when an error occurs as a key.

Solaris

The command log is stored in the command log file in the start log directory, shown in [Figure 3-1](#). The error log is stored in the HORCM error log file in the error log directory, also shown in [Figure 3-1](#). The following are locations for storing the command log and error log in the case where the directories are not specified using the environmental variable, HORCC_LOG.

Command log: /HORCM/logINS/horcc_HOST.log

Error log: /HORCM/logINS/curlog/horcmlog_HOST/horcm.log

- INS is an instance number.
- HOST is a host name of the computer concerned.

```
COMMAND ERROR : EUserId for HOMRCF : root (0) Tue Dec 2 18:18:07 2003
CMDLINE : paircreate -g SI -d SI_000 -v1 -c 15
18:18:08-95274-03005- ERROR:cm_sndrcv[rc < 0 from HORCM]
18:18:08-9fe17-03005- [paircreate] L_CMD(CREATEPAIR) ERROR :rc = -35
18:18:08-aleaa-03005- [paircreate][exit(221)]
[EX_CMDRJE] An order to the control/command device was rejected
[Cause ]: An order to the command(control) device failed,or was rejected.
[Action]:Please confirm the following items.If this trouble doesn't resolve,then collect HORCM
error logs(HORCM_LOG=/HORCM/log0/curlog) and trace data,and send them to service personnel.
(1) Check if the 'HORC or HOMRCF function' is installed in the RAID.
(2) Check if the RCP and LCP are installed in the RAID.
(3) Check if the path between the RAID CUs is established by using the SVP.
(4) Check if the pair target volume is an appropriate status.
```

Error occurs time

Figure 3-3: Command Log Output Example (Solaris)

```
18:18:07-d9ble-02746- SCSI : Check Condition.
18:18:07-dedfd-02746-          ***** SCSI SENSE DATA *****
---ADDR--- -OFF-  0-1-2-3- 4-5-6-7- 8-9-A-B- C-D-E-F-  -----CHAR-----
[0xffbeef14]0000:  70000500 00000038 84000039 95760000  p.....8...9.v..
[0xffbeef24]0010:  00001000          ....
18:18:07-ef183-02746- SKEY = 0x05
18:18:07-f326b-02746- ASC = 0x95
[System Call Error]
SysCall: write
Errorno: 22 (Invalid argument)
ErrInfo: Internal Error
ErrTime: Tue Dec 2 18:18:08 2003
SrcFile: horcprc.c
SrcLine: 1178
```

Sense code
Detail code
Sub code
Error occurs time

Figure 3-4: Error Log Output Example (Solaris)

Linux

In the same way as Solaris, the command log is stored in the command log file in the start log directory, shown in Figure 3-1. The error log is stored in the HORCM error log file in the error log directory, also shown in Figure 3-1. The following are locations for storing the command log and error log in the case where the directories are not specified using the environmental variable, HORCC_LOG.

Command log: /HORCM/logINS/horcc_HOST.log

Error log: /HORCM/logINS/curlog/horcmlog_HOST/horcm.log

- INS is an instance number.
- HOST is a host name of the computer concerned.

```
COMMAND ERROR : EUserId for HORC : root (0) Mon Dec 8 10:28:12 2003
CMDLINE : pairsplit -g vgl -d vg120 -S
10:28:13-3201d-05247- ERROR:cm_sndrcv[rc < 0 from HORCM]
10:28:13-3f438-05247- [pairsplit] L_CMD(ERASEPAIR) ERROR :rc = -35
10:28:13-43af5-05247- [pairsplit][exit(221)]
[EX_CMDRJE] An order to the control/command device was rejected
[Cause ]: An order to the command(control) device failed,or was rejected.
[Action]:Please confirm the following items.If this trouble doesn't resolve,then collect HORCM
error logs(HORCM_LOG=/HORCM/log2/curlog) and trace data,and send them to service personnel.
(1) Check if the 'HORC or HOMRCF function' is installed in the RAID.
(2) Check if the RCP and LCP are installed in the RAID.
(3) Check if the path between the RAID CUs is established by using the SVP.
(4) Check if the pair target volume is an appropriate status.
```

Figure 3-5: Command Log Output Example (Linux)

```
10:28:12-600f8-01422- SCSI : Check Condition.
10:28:12-6c792-01422-          ***** SCSI SENSE DATA *****
---ADDR--- -OFF-  0-1-2-3- 4-5-6-7- 8-9-A-B- C-D-E-F-  -----CHAR-----
[0xbffec628]0000:  70000500 00000038 84000039 95760000  p.....8...9.v..
10:28:12-79b71-01422- SKEY = 0x05
10:28:12-7e218-01422- ASC = 0x95
[System Call Error]
SysCall: write
Errorno: 22 (Invalid argument)
ErrInfo: Internal Error
ErrTime: Mon Dec 8 10:28:12 2003
SrcFile: horcprc.c
SrcLine: 1178
```

Figure 3-6: Error Log Output Example (Linux)

Windows

In the same way as Solaris, the command log is stored in the command log file in the start log directory, shown in Figure 3-1. The error log is stored in the HORCM error log file in the error log directory, also shown in Figure 3-1. The following are locations for storing the command log and error log in case the directories are not specified using the environmental variable, HORCC_LOG.

Command log: \HORCM\logINS\horcc_HOST_log.txt

Error log: \HORCM\logINS\curlog\horcmlog_HOST\horcm_log.txt

- INS is an instance number.
- HOST is a host name of the computer concerned.

```
COMMAND ERROR : EUserId for HOMRCF : Administrator (0) Thu Feb 19 05:11:14 2004
CMDLINE : pairresync -g vg01 -d oradb1
05:11:14-81a38-01860- ERROR:cm_sndrcv[rc < 0 from HORCM]
05:11:14-854d0-01860- [pairresync] L_CMD(CREATEPAIR) ERROR :rc = -35 Error occurs time
05:11:14-854d0-01860- [pairresync][exit(221)]
[EX_CMDRJE] An order to the control/command device was rejected
[Cause ]: An order to the command(control) device failed,or was rejected.
[Action]:Please confirm the following items.If this trouble doesn't resolve,then collect HORCM
error logs(HORCM_LOG=C:\HORCM\log137\curlog) and trace data ,and send them to service personnel.
(1) Check if the 'HORC or HOMRCF function' is installed in the RAID.
(2) Check if the RCP and LCP are installed in the RAID.
(3) Check if the path between the RAID CUs is established by using the SVP.
(4) Check if the pair target volume is an appropriate status.
```

Figure 3-7: Command Log Output Example (Windows)

```
05:11:14-81a38-01928- SCSI : Check Condition.
05:11:14-81a38-01928- ***** SCSI SENSE DATA *****
---ADDR--- -OFF- 0-1-2-3- 4-5-6-7- 8-9-A-B- C-D-E-F- -----CHAR-----
[0x0012f318]0000: 70000500 00000038 84000039 96080000 p.....8...9.v..
[0x0012f328]0010: 00001000 84000039 00000000 1fd00000 .....9.....
[0x0012f338]0020: 00000000 00000000 00000000 00000000 .....
[0x0012f348]0030: 00000000 00000000 00000000 00000000 .....
[0x0012f358]0040: 00000000 00000000 00000000 00000000 .....
[0x0012f368]0050: 00000000 00000000 00000000 00000000 .....
05:11:14-81a38-01928- SKEY = 0x05
05:11:14-81a38-01928- ASC = 0x96
05:11:14-81a38-01928- SSB = 0x8400,0039
[System Call Error]
SysCall: write
Errorno: 22 (Invalid argument)
ErrInfo: Internal Error
ErrTime: Thu Feb 19 05:11:14 2004
SrcFile: horcprc.c
SrcLine: 1182
```

Figure 3-8: Error Log Output Example (Windows)

Sense code and detail code

Table 3-5 shows sense codes and detailed codes. 0~A will be set in the x of detailed codes.

Table 3-5: Sense Codes

Sense code	Detailed code	Sub code	Error contents	Recommended Action
2602			The primary sequence number is beyond the limits of supported.	Check the serial number.
2602			The secondary sequence number is beyond the limits of supported.	Check the serial number.
2602			The LUN of the P-VOL is beyond the limits of supported.	Check the specified LUN.
2602			The LUN of the S-VOL is beyond the limits of supported.	Check the specified LUN.
2602			The primary port number is beyond the limits of supported.	Check the specified port number.
2602			The secondary port number is beyond the limits of supported.	Check the specified port number.
2602			The object LU is beyond the limits of supported.	Check the status of the LU.
2602			The object LU is undefined.	Check the status of the LU.
2602			The environment has a problem.	Check the environment of CCI.
2602			The retention term is beyond the limits of validity.	Check that the specified value that has been set is 0 to 21900.
3180			The object LU is unformatted.	Check the status of the LU.
9501			A command was received during execution of the pseudo deliberate shutdown.	Retry after the pseudo deliberate shutdown is completed.
9510			A command was received during a performance of hot replacement of the firmware.	Retry after waiting for a while.
9531			The password protection is being logged in.	Retry after waiting for a while.
9536			The optional feature is invalid.	Install the optional feature.
9552			The object LU is defined as a command device.	Check the attribute of the LU.
9557			LU capacities of the P-VOL and S-VOL are not the same.	Check the capacity of the LU.
956B			The capacity is beyond the limits of supported.	Split the unnecessary pairs.
9576	0000	84	The pair status of the P-VOL is other than SMPL.	Check the pair status of the LU.
9576	0001	84	The status of the P-VOL is other than normal or regressive.	Check the status of the LU.
9576	0002	84	The P-VOL is a Cache Residency LU.	Check the status of the LU.

Table 3-5: Sense Codes (Continued)

Sense code	Detailed code	Sub code	Error contents	Recommended Action
9576	0003	84	The P-VOL is reserved as a Cache Residency LU.	Check the status of the LU.
9576	0004	84	The P-VOL is a command device.	Check the status of the LU.
9576	0005	84	The primary sequence number is different from the own Array ID.	Check the Array ID.
9576	0006	84	Both of the two paths are abnormal.	Check the status of the path.
9576	0007	84	The P-VOL has been defined as a SubLU of a unified LU.	Check the status of the LU.
9576	0009	84	There exist maximum number of pairs already.	Delete the unnecessary pairs.
9576	000D	84	The P-VOL is in a status other than PSUS or PSUE.	Check the pair status of the LU.
9576	000E	84	The status of the P-VOL is other than normal or regressive.	Check the pair attribute of the LU.
9576	000F	84	The number of the LU to be paired is different.	Check the specified LUN.
9576	0010	84	The primary sequence number is different from the own Array ID.	Check the Array ID.
9576	0011	84	Both of the two paths are abnormal.	Check the status of the path.
9576	0012	84	The specified P-VOL is in a status other than COPY or PAIR.	Check the pair status of the LU.
9576	0014	84	The current Array ID differs from the number that was set initially.	Check the Array ID.
9576	0016	84	The number of the LU to be paired is different.	Check the specified LUN.
9576	0017	84	The primary sequence number is different from the own Array ID.	Check the Array ID.
9576	0018	84	The pairsplit -R command to a P-VOL or the pairsplit -S command to an S-VOL was received.	Check the pair status of the LU.
9576	0020	84	The Asynchronous mode is turned on.	The Asynchronous mode is not supported.
9576	0021	84	The fence level is STATUS.	Make sure of the specified fence level.
9576	0023	84	The P-VOL is a volume of ShadowImage. It is in the PSUE status and cannot accept Read/Write instructions.	Check the pair status of the LU.
9576	0024	84	The P-VOL is undergoing the restoration of ShadowImage pair.	Check the pair status of the LU.
9576	0025	84	The P-VOL received an instruction to swap pair.	Check the pair status of the LU.
9576	0026	84	The pair status is not SSWS.	Check the pair status of the LU.

Table 3-5: Sense Codes (Continued)

Sense code	Detailed code	Sub code	Error contents	Recommended Action
9576	0027	84	The S-VOL received an instruction to resynchronize pair.	Check the pair status of the LU.
9576	0028	84	The volume is a P-VOL of ShadowImage. It is in the PSUE status and cannot accept Read/Write instructions.	Place the P-VOL concerned in the SMPL status and create the pair again.
9576	0029	84	The volume is a P-VOL of ShadowImage and undergoing a reverse copy.	Check the pair status of the LU.
9576	002A	84	The P-VOL received an instruction to be taken over.	Check the pair status of the LU.
9576	002B	84	It is in the SMPL or COPY status.	Check the pair status of the LU.
9576	002C	84	The secondary sequence number is different from the Array ID.	Check the Array ID.
9576	002D	84	The S-VOL received an instruction to be taken over.	Check the pair status of the LU.
9576	002E	84	The pair status of the P-VOL is SMPL or COPY.	Check the pair status of the LU.
9576	002F	84	The primary sequence number is different from the Array ID.	Check the Array ID.
9576	0030	84	The S-VOL received the pairsplit - E (pair suspend) command.	Check the pair status of the LU.
9576	0031	84	The capacity is beyond the limits of support.	Split the unnecessary pairs.
9576	0032	84	The P-VOL is configured as RAID 0.	Check the RAID level of the specified LU.
9576	0033	84	The specified LU is an S-VOL of ShadowImage and it is in a pair status other than PSUS.	Check the pair status of the LU.
9576	0035	84	The volume is an S-VOL of ShadowImage and it is in a pair status other than PSUS.	Check the pair status of the LU.
9576	0036	84	The volume is a P-VOL of SnapShot and being restored.	Check the pair status of the LU.
9576	0037	84	The volume is a P-VOL of SnapShot. It is in the PSUE status and cannot accept Read/Write instructions.	Change the statuses of all V-VOLs of the P-VOL concerned to SMPL, and create the pair again.
9576	0038	84	The volume is a P-VOL of SnapShot and the mate to it has already been paired by TrueCopy.	Check the pair status of the LU.
9576	0039	84	The volume is a V-VOL of SnapShot and it is in a status other than PSUS of SnapShot.	Check the pair status of the LU.

Table 3-5: Sense Codes (Continued)

Sense code	Detailed code	Sub code	Error contents	Recommended Action
9576	003A	84	The volume is a V-VOL of SnapShot. The related P-VOL of SnapShot is being restored or has been placed in the PSUE status during a restoration.	Check the pair status of the LU.
9576	003B	84	The specified LU is comprised in a SnapShot pair and it has already been cascaded with a TrueCopy pair.	Check the pair status of the LU.
9576	003C	84	The specified LU is comprised in a SnapShot pair and it has already been cascaded with a TrueCopy pair.	Check the pair status of the LU.
9576	003D	84	The volume is a P-VOL of SnapShot and being restored.	Check the pair status of the LU.
9576	003E	84	The volume is a P-VOL of SnapShot. It is in the PSUE status and cannot accept Read/Write instructions.	Change the statuses of all V-VOLs of the P-VOL concerned to SMPL, and create the pair again.
9576	003F	84	The volume is a V-VOL of SnapShot and it is in a status other than PSUS of SnapShot.	Check the pair status of the LU.
9576	0040	84	The volume is a P-VOL of SnapShot. It is being restored or in the PSUE status and cannot accept Read/Write instructions.	Check the pair status of the LU.
9576	0041	84	The number of unified LUs is 17 or more.	Check the number of unified LUs of the volume corresponding to the specified LU.
9576	0042	84	The RAID level differs between the MainLU and SubLU.	Check that the RAID level of the specified LU is the same as that expected.
9576	0043	84	The number of data disks differs between the MainLU and SubLU.	Check that the number of data disks of the specified LU is the same as that expected.
9576	0044	84	The specified LU is a V-VOL of SnapShot. The P-VOL of the related SnapShot pair is a unified LU and the number of unified LUs is 17 or more.	Check the number of unified LUs of the SnapShot P-VOL corresponding to the specified LU.
9576	0045	84	The specified LU is a V-VOL of SnapShot. The P-VOL of the related SnapShot pair is a unified LU, whose MainLU and SubLU are different in RAID level.	Check that the RAID level of the SnapShot P-VOL corresponding to the specified LU is the same as that expected.

Table 3-5: Sense Codes (Continued)

Sense code	Detailed code	Sub code	Error contents	Recommended Action
9576	0046	84	The specified LU is a V-VOL of SnapShot. The P-VOL of the related SnapShot pair is a unified LU, whose MainLU and SubLU are different in number of data disks.	Check that the number of data disks of the SnapShot P-VOL corresponding to the specified LU is the same as that expected.
9576	0047	84	Data of the TrueCopy P-VOL is partially destroyed.	Issue the Snapshot instruction (to change the status from PAIR to PSUS) to the SnapShot pair again, and then create the pair again.
9576	0048	84	Data of the TrueCopy P-VOL is partially destroyed.	Format the specified LU after getting backup data of it. Then restore the backup data.
9576	0049	84	A problem occurred in the pair.	After splitting the pair, create a pair again.
9576	004A	84	A problem occurred in the pair.	After splitting the pair, create a pair again.
9576	004B	84	The specified P-VOL is in the PSUE (S-VOL Switch) status of ShadowImage.	Request the service personnel to replace drives that compose the P-VOL. Format them after the replacement, and then resynchronize them.
9576	004D	84	The DM-LU is not set.	Retry after setting the DM-LU.
9576	004E	84	The DM-LU cannot be specified as P-VOL.	Check the status of the LU.
9576	004F	84	Validity of the license expired.	Purchase the license.
9576	0052	84	The pairsplit -mscas was issued in the TrueCopy environment.	The pairsplit -mscas is not supported in the TrueCopy environment.
9576	0053	84	The specified P-VOL is the reserved LU.	Check the status of the LU.
9576	0054	84	The specified P-VOL is undergoing the migration.	Check the pair status of the LU.
9576	0055	84	The disk drives that configure a RAID group, to which the specified P-VOL belongs have been spun down.	Check the status of the RAID group.
9576	0056	84	The disk drives that configure a RAID group, to which the specified P-VOL belongs have been spun down.	Check the status of the RAID group.
9576	0057	84	The specified function is not supported in a remote array.	Check the remote array.
9576	0058	84	When creating pairs with CTG is specified, the specified CTG ID is beyond the limits of supported.	Check the specified CTG ID.

Table 3-5: Sense Codes (Continued)

Sense code	Detailed code	Sub code	Error contents	Recommended Action
9576	0059	84	A pair was created with an S-VOL that was placed in the SMPL status by the pair cancellation instructions for only S-VOL and its pair status became PSUS(N).	Check the pair status of the specified S-VOL.
9576	005A	84	The command was received in unit of CTG at the time of resynchronization (including swap).	Check the specified value.
9576	005B	84	When the unit of CTG is specified, the specified S-VOL is not created pair with CTG.	Check the status of the LU.
9576	005C	84	When the unit of CTG is specified, there is a P-VOL in the same CTG.	Check the CTG ID.
9576	005D	84	When the unit of CTG is specified, there is no pair, which is in the PAIR, PSUS, or PSUE status, in the same CTG.	Check the pair status of LU in the CTG.
9576	005E	84	When the unit of CTG is specified, the specified P-VOL is not created pair with CTG.	Check the status of the LU.
9576	005F	84	When the unit of CTG is specified, there is an S-VOL in the same CTG.	Check the CTG ID.
9576	0060	84	When the unit of CTG is specified, there is no pair, which is in the PAIR, PSUS, or PSUE status, in the same CTG.	Check the pair status of LU in the CTG.
9576	0061	84	When the unit of CTG is specified, the specified P-VOL is not created pair with CTG.	Check the status of the LU.
9576	0062	84	When the unit of CTG is specified, there is an S-VOL in the same CTG.	Check the CTG ID.
9576	0063	84	When the unit of CTG is specified, there is no pair, which is in the COPY or PAIR status, in the same CTG.	Check the pair status of LU in the CTG.
9576	0064	84	The pair cancellation instruction was executed for the range that was not supported.	Check the specified value.
9576	0065	84	When the unit of CTG is specified, the specified P-VOL is not created pair with CTG.	Check the status of the LU.
9576	0066	84	When the unit of CTG is specified, there is an S-VOL in the same CTG.	Check the CTG ID.

Table 3-5: Sense Codes (Continued)

Sense code	Detailed code	Sub code	Error contents	Recommended Action
9576	0067	84	When the unit of CTG is specified, the specified S-VOL is not created pair with CTG.	Check the status of the LU.
9576	0068	84	When the unit of CTG is specified, there is a P-VOL in the same CTG.	Check the CTG ID.
9576	0069	84	The specified secondary sequence number does not match with the array serial number.	Check the specified command device number.
9576	006A	84	The command cannot execute because the Auto Migration is undergoing.	Check the Migration status.
9576	006B	84	The command cannot execute because the Auto Migration is undergoing.	Check the Migration status.
9576	006C	84	The command cannot execute because the Auto Migration is undergoing.	Check the Migration status.
9576	006D	84	There are other pairs in the group, whose fence level is not the same as the one specified.	Confirm the fence level of the pair you are creating.
9576	006E	84	There are other pairs in the group, whose P-VOL and S-VOL are swapped.	Confirm the array on which you are executing the command.
9576	0072	84	The RAID group to which the specified LU belongs indicates a status other than Normal.	Retry after the status becomes Normal.
9576	0073	84	An LU that belongs to the RAID group that indicates a status other than Normal is included in the data pool that is used by pairs in the specified group.	Retry after the RAID group status becomes Normal.
9576	0077	84	The LU created in DP pool was specified as P-VOL.	Specify an LU other than the LU created in DP pool.
9576	0078	84	The LU that was specified as P-VOL does not exist.	Check the specified LUN.
9576	0079	84	The specified P-VOL is a volume of ShadowImage pair that includes the LU created in DP pool.	Confirm the ShadowImage pair that includes the specified P-VOL.
9576	007A	84	The specified P-VOL is a volume of ShadowImage pair that includes the LU created in DP pool.	Confirm the ShadowImage pair that includes the specified P-VOL.
9576	007B	84	The P-VOL is also an S-VOL in a ShadowImage pair. The P-VOL in this ShadowImage pair is in another ShadowImage pair, in which the S-VOL is a volume created with a DP pool LU.	Confirm the ShadowImage S-VOLs having the same P-VOL

Table 3-5: Sense Codes (Continued)

Sense code	Detailed code	Sub code	Error contents	Recommended Action
9576	007C	84	Management information of Dynamic Provisioning is being updated.	Retry after waiting for a while.
9576	007D	84	The operation cannot be performed due to insufficient capacity of the DP pool for the specified P-VOL.	Check the capacity of the DP pool.
9576	007E	84	The operation cannot be performed due to insufficient capacity of the DP pool for the specified S-VOL.	Check the capacity of the DP pool.
9576	007F	84	The memory reconfiguration process is in progress.	Retry after the memory reconfiguration process completes.
9576	0080	84	The memory reconfiguration process is in progress.	Retry after the memory reconfiguration process completes.
9576	0081	84	The status of the specified S-VOL is SMPL, COPY, or PAIR.	Check the pair status.
9576	0082	84	There are no pairs in the specified group whose status is SSWS.	Check the pair status.
9576	905E	94	There is a SnapShot pair, which has an MU number specified for a SnapShot P-VOL, has not been placed in the PAIR or PSUS status, and whose S-VOL is one of the S-VOLs with the specified CTG numbers. Otherwise, the process of reconfigure memory is in progress on the remote array.	Check the pair status of the SnapShot. Otherwise, retry after the process of reconfigure memory is completed.
9576	905F	94	There is no pair, which is in the PAIR status, in the target CTG.	Check the pair status of the LU.
9576	x005	94	The LU of the remote array is being formatted.	Retry after waiting for a while.
9576	x006	94	The remote array is undergoing the pseudo deliberate shutdown.	Retry after the pseudo deliberate shutdown is completed.
9576	x007	94	The remote array has undergone the pseudo deliberate shutdown.	Retry after waiting for a while.
9576	x008	94	The S-VOL is undefined.	Check the status of the LU.
9576	x009	94	The WWN of the remote array is illegal.	Check the array WWN.
9576	x00B	94	The remote array is undergoing hot replacement of the firmware.	Retry after waiting for a while.
9576	x00C	94	A command error occurred.	Retry after waiting for a while.
9576	x00D	94	The optional feature of TrueCopy of the remote array is invalid.	Unlock and validate the optional feature.

Table 3-5: Sense Codes (Continued)

Sense code	Detailed code	Sub code	Error contents	Recommended Action
9576	x00E	94	The status of the S-VOL cannot be changed.	Retry after waiting for a while.
9576	x011	94	The object LU has already been organized into a TrueCopy or TCE pair. Besides, the serial number differs between the local and remote arrays.	Check the pair status of the LU and serial number.
9576	x012	94	The number of TrueCopy or TCE pairs exceeded the maximum value that can be supported.	Check the number of TrueCopy or TCE pairs.
9576	x014	94	The current serial number differs from the number that was set initially.	Check the serial number.
9576	x015	94	The status of the object P-VOL or S-VOL is other than normal and regression or the specified S-VOL is an LU created in DP pool or a volume of ShadowImage pair that includes the LU created in DP pool.	Make the status of the P-VOL or S-VOL normal or regression and confirm the S-VOL and the ShadowImage pair that the specified S-VOL is part of.
9576	x017	94	The S-VOL is configured as RAID 0.	Check the RAID level of the specified LU.
9576	x019	94	The capacity differs between the P-VOL and S-VOL.	Equalize the capacities of the P-VOL and S-VOL.
9576	x01A	94	The S-VOL is a Cache Residency LU or has been set to the reserved Cache Residency LU.	Check the status of the LU.
9576	x01C	94	The object LU is a command device.	Specify an LU other than a command device.
9576	x01D	94	The change of the default owner controller is reserved for the object LU.	Cancel the reservation for changing the default owner controller or specify the LU for which the change of the default owner controller is not reserved.
9576	x01E	94	The object LU is in a TrueCopy pair, or the RAID group to which the object LU belongs indicates a status other than Normal.	Check the pair status of the LU and the RAID group status. If RAID group status is other than Normal, retry when it becomes Normal.
9576	x020	94	The object LU of the remote array is being restored as a volume of ShadowImage or cannot accept Read/Write instructions.	Check the pair status of the LU.
9576	x021	94	The object LU has already been cascaded with a ShadowImage pair.	Check the pair status of the LU and check that its pair attribute is P-VOL.
9576	x02A	94	The optional feature of TrueCopy of the remote array is invalid.	Unlock and validate the optional feature.

Table 3-5: Sense Codes (Continued)

Sense code	Detailed code	Sub code	Error contents	Recommended Action
9576	x02B	94	Both of the two paths of the remote array were detached.	Check the status of the path.
9576	x030	94	The S-VOL is undefined.	Check the attribute of the LU.
9576	x031	94	The WWN of the remote array is illegal.	Check the remote array WWN.
9576	x032	94	The remote array is receiving a command.	Retry after waiting for a while.
9576	x035	94	The optional feature of TrueCopy or TCE of the remote array is invalid.	Unlock and validate the optional feature.
9576	x038	94	Both of the two paths of the remote array were detached.	Check the status of the path.
9576	x03D	94	Pair status of corresponding LU does not match.	Confirm the pair status of LU and the other side's LUN.
9576	x03F	94	The LU assigned to a TrueCopy pair has already been paired by ShadowImage.	Check the pair status of the LU.
9576	x040	94	The object LU of the remote array is being paired as a volume of ShadowImage whose status is RCPY or cannot accept Read/Write instructions.	Check the pair status of the LU.
9576	x041	94	The process is in progress.	Retry after waiting for a while.
9576	x045	94	The stripe size of the object LU of the remote array is other than 64 kB.	Make the stripe size of the LU of the remote array 64 kB.
9576	x046	94	The object LU of the remote array is being restored as a volume of SnapShot or cannot accept Read/Write instructions.	Place the SnapShot pair, which comprises the LU of the remote array, in the SMPL status once and then operate the pair.
9576	x047	94	The specified LU is an S-VOL of ShadowImage.	Specify an LU other than a ShadowImage S-VOL that comprises the LU of the remote array (at the time of a swap).
9576	x048	94	The specified LU is an S-VOL of ShadowImage.	Split the ShadowImage pair that comprises an LU of the remote array.
9576	x049	94	The object LU of the remote array is being quick formatted. Management information of Dynamic Provisioning for the LU specified as S-VOL in the remote array is being updated.	Create the pair again after the quick formatting is completed. Retry after waiting a while.

Table 3-5: Sense Codes (Continued)

Sense code	Detailed code	Sub code	Error contents	Recommended Action
9576	x04A	94	The S-VOL is in the S-VOL Disable mode.	Cancel the S-VOL Disable specified for the LU of the remote array.
9576	x04B	94	The P-VOL is in the S-VOL Disable mode.	Cancel the S-VOL Disable specified for the LU of the remote array (at the time of a swap).
9576	x050	94	The object LU of the remote array has not undergone the forced restoration by means of parity or it is undergoing the restoration above.	Make the status, which concerns the forced restoration by means of parity, of the LU of the remote array to Restored or Skip.
9576	x053	94	The number of unified LUs of the remote array is 17 or more.	Make the number of unified LUs of the remote array 16 or less.
9576	x054	94	The V-VOL, which is paired with a SnapShot P-VOL of the remote array has already been organized into a TrueCopy pair.	Split the TrueCopy pair comprising a SnapShot V-VOL that is an LU of the remote array.
9576	x055	94	The object LU of the remote array is a V-VOL of SnapShot (at the time of a pair formation).	Specify the LU of the remote array to a volume other than a V-VOL of SnapShot.
9576	x056	94	The object LU of the remote array is a V-VOL of SnapShot (at the time of a resynchronizing swap).	Specify the LU of the remote array to a volume other than a V-VOL of SnapShot.
9576	x059	94	The license validity of the remote array is expired. Otherwise, the memory reconfiguration process is in progress on the remote array.	Purchase the license or retry after the memory reconfiguration process completes.
9576	x05A	94	The DM-LU is not set of the remote array or the DM-LU was specified as S-VOL.	Retry after setting the DM-LU or check the status of the LU.
9576	x05B	94	The specified S-VOL is the pool LU.	Check the status of the LU.
9576	x05D	94	The process is in progress.	Retry after waiting for a while.
9576	x089	94	The S-VOL of the remote array is in the status of S-VOL Disable.	Check the status of the remote array and cancel the access attribute.
9576	x08B	94	This operation cannot be executed due to lack of resources within the remote array. Try the operation again after deleting unnecessary pairs.	Check the pool LU status of the remote array.
9576	x08C	94	This operation cannot be executed due to lack of resources within the remote array. Try the operation again after waiting for a while.	Check the pool LU status of the remote array and retry after waiting for a while.

Table 3-5: Sense Codes (Continued)

Sense code	Detailed code	Sub code	Error contents	Recommended Action
9576	x08D	94	The S-VOL of the remote array does not meet the conditions of cascading with a SnapShot pair.	Check the LU status of the LU in the remote array.
9576	x090	94	The S-VOL of the remote array does not meet the conditions of cascading with a SnapShot pair.	Check the LU status of the LU in the remote array.
9576	x091	94	The indicated Array ID is not same as the actual one for remote array.	Confirm the Array ID for the remote array.
9576	x095	94	The S-VOL in the remote array is undergoing the forced parity correction.	Check the status of the remote array and retry after waiting for a while.
9576	x097	94	The S-VOL in the remote array received an illegal command.	Check the status of the remote array.
9576	x09A	94	The LU status of the S-VOL in the remote array is normal or other than regressed.	Check the LU status of the remote array.
9576	x09F	94	The internal transaction which are splitting or deleting for SnapShot is working now.	Retry after waiting for a while.
9576	x0A0	94	The remote array has no pool LU.	Make a pool LU for the remote array.
9576	x0A1	94	The LU specified as the S-VOL in the remote array is a pool LU.	The pool LU cannot be set to an S-VOL. Check the pool LU status of the remote array.
9576	x0A2	94	The LU status of the S-VOL in the remote array is normal or other than regressed.	Check the pool LU status of the remote array.
9576	x0A3	94	The pool LU in the remote array is undergoing the forced parity correction.	Check the pool LU status of the remote array and retry after waiting for a while.
9576	x0A4	94	The S-VOL in the remote array exceeded the total allowable maximum number of TCE and SnapShot pairs.	Check the status of the remote array. In addition, delete unnecessary pairs of the remote array.
9576	x0A5	94	The TCE pair status of the S-VOL in the remote array is PSUE.	Check the TCE pair status of the remote array.
9576	x0A6	94	The TCE pair status of the S-VOL in the remote array is PFUS.	Check the TCE pair status of the remote array.
9576	x0A7	94	The TCE pair status of the S-VOL in the remote array is PSUS (no reading or writing allowed).	Check the TCE pair status of the remote array.
9576	x0A8	94	The TCE pair status of the S-VOL in the remote array is SSWS (including SSWS(R)).	Check the TCE pair status of the remote array.
9576	x0A9	94	The TCE pair status of the S-VOL in the remote array is SMPL.	Check the TCE pair status of the remote array.
9576	x0AA	94	The TCE pair status of the S-VOL in the remote array is PSUS.	Check the TCE pair status of the remote array.

Table 3-5: Sense Codes (Continued)

Sense code	Detailed code	Sub code	Error contents	Recommended Action
9576	x0AB	94	The TCE pair status of the S-VOL in the remote array is not SMPL.	Check the TCE pair status of the remote array.
9576	x0B3	94	The specified S-VOL is a unified LU including a SubLU with a capacity less than 1 GB.	Check whether the LU with a capacity less than 1 GB is included in each LU of the specified unified LU.
9576	x0B4	94	The S-VOL in the remote array does not exist on the default owner controller and, at the same time, the special processing cannot be continued.	Check the status of the remote array and retry after waiting for a while.
9576	x0B5	94	The S-VOL in the remote array does not exist on the default owner controller and, at the same time, an ownership of LU change for it has been started.	Check the status of the remote array and retry after waiting for a while.
9576	x0B6	94	The S-VOL in the remote array does not exist on the default owner controller and it has started an ownership of LU change.	Check the status of the remote array and retry after waiting for a while.
9576	x0B7	94	The S-VOL in the remote array does not exist on the default owner controller and, at the same time, an ownership of LU to be changed is blocked.	Check the status of the remote array and retry after waiting for a while.
9576	x0B8	94	The S-VOL in the remote array cannot change an ownership of LU and, at the same time, it is using the sequential buffer.	Check the status of the remote array and retry after waiting for a while.
9576	x0B9	94	The S-VOL in the remote array cannot change an ownership of LU temporarily.	Retry after waiting for a while.
9576	x0BA	94	The S-VOL in the remote array cannot change an ownership of LU and, at the same time, it has pinned data.	Contact the service personnel.
9576	x0BB	94	The S-VOL in the remote array cannot change an ownership of LU temporarily.	Retry after waiting for a while.
9576	x0BC	94	The S-VOL in the remote array cannot change an ownership of LU temporarily.	Retry after waiting for a while.
9576	x0BD	94	The S-VOL in the remote array cannot change an ownership of LU and a time-out occurred.	Check the status of the remote array and retry after waiting for a while.
9576	x0BE	94	The S-VOL in the remote array cannot change an ownership of LU and, at the same time, the group# is illegal.	Check the status of the remote array.

Table 3-5: Sense Codes (Continued)

Sense code	Detailed code	Sub code	Error contents	Recommended Action
9576	x0C0	94	The S-VOL in the remote array does not exist on the default owner controller and, at the same time, it is making the drive spun up.	Check the status of the remote array and retry after waiting for a while.
9576	x0C1	94	The S-VOL in the remote array does not exist on the default owner controller and, at the same time, it is making the system copy.	Check the status of the remote array and retry after waiting for a while.
9576	x0C2	94	The S-VOL in the remote array does not exist on the default owner controller and, at the same time, it is writing the takeover information.	Check the status of the remote array and retry after waiting for a while.
9576	x0C4	94	When a new pair of a CTG is created, the cycle time that has been set for the local and remote array is less than the minimum interval.	Check the cycle time that has been set for the local and remote array.
9576	x0C6	94	The specified S-VOL is undergoing the migration.	Re-execute the migration after splitting the pair.
9576	x0C7	94	The specified S-VOL is the reserved LU.	Re-execute the migration specifying an LU other than the reserved LU for the S-VOL.
9576	x0CA	94	The specified S-VOL is undergoing the migration.	Re-execute the migration after splitting the pair.
9576	x0CB	94	The specified S-VOL is the reserved LU.	Re-execute the migration specifying an LU other than the reserved LU for the S-VOL.
9576	x0CF	94	The disk drives that configure a RAID group, to which a target LU in the remote array belongs have been spun down.	Perform the operation again after spinning up the disk drives that configure the RAID group.
9576	x0D1	94	The disk drives that configure a RAID group, to which a target LU in the remote array belongs have been spun down.	Perform the operation again after spinning up the disk drives that configure the RAID group.
9576	x0D2	94	The S-VOL pool number in the remote array is not same as the one that is being used for SnapShot.	Confirm the indicated pool number in the remote array.
9576	x0D3	94	The license validity of the remote array is expired.	Purchase the license.
9576	x0D4	94	The S-VOL pair attribute in the remote array is P-VOL.	Check the LU status of the remote array.
9576	x0D7	94	The indicated S-VOL is not PSUS status in the ShadowImage pair.	Execute again after having the ShadowImage pair status in the remote array be PSUS or SMPL.

Table 3-5: Sense Codes (Continued)

Sense code	Detailed code	Sub code	Error contents	Recommended Action
9576	x0D8	94	The indicated S-VOL is not PSUS status in the SnapShot pair.	Execute again after having the SnapShot pair status in the remote array be PSUS or SMPL.
9576	x0D9	94	The Array ID of the remote array does not match, or TCE pairs whose status is other than COPY or PSUS, or ShadowImage or SnapShot pairs whose status is other than PSUS exist in the specified CTG.	Confirm the Array ID, pair status of ShadowImage, SnapShot, and TCE.
9576	x0DB	94	The partition or pair partition to which the target LU belongs is incorrect.	Check the partition number.
9576	x0DD	94	The firmware internal error occurred.	Retry after waiting for a while. If an error occurred again, contact the service personnel.
9576	x0DE	94	Auto Migration is being executed in the remote array just now.	Execute again after the Migration is completed.
9576	x0E1	94	The operation to change LU has become timeout while the remote array controller is recovering.	Retry the operation after the controller is recovered.
9576	x0E3	94	The LU will be specified as an S-VOL in the remote array. The RAID group to which the LU belongs indicates a status other than Normal.	Retry when the status becomes Normal.
9576	x0E9	94	The specified S-VOL is a volume of ShadowImage pair that includes the LU created in DP pool.	Confirm the S-VOL and the ShadowImage pair that the specified S-VOL is part of.
9576	x0F1	94	Management information of Dynamic Provisioning for the LU specified as S-VOL in the remote array is being updated.	Retry after waiting a while.
9576	x0F2	94	The memory reconfiguration process is in progress on the remote array.	Retry after the memory reconfiguration process completes.
9576	x0F5	94	The full capacity mode differs between the P-VOL and S-VOL. Or the full capacity mode is not supported.	Set both P-VOL and S-VOL the same value. Or check the firmware version of array.
9591			There exist maximum number of pairs already.	Split the unnecessary pairs.
9606			The P-VOL or S-VOL is an invalidated LU.	Check the status of the LU.
9607			The P-VOL or S-VOL is a P-VOL (other than SMPL, or the SMPL and a V-VOL that has been set) or a V-VOL of SnapShot.	Check the pair status.

Table 3-5: Sense Codes (Continued)

Sense code	Detailed code	Sub code	Error contents	Recommended Action
9608	0000	84	In the operation to change an ownership of LU, an LU having pinned data was specified.	Retry after eliminating pinned data.
9608	0001	84	The controller that controls the LU cannot be changed temporarily.	Retry after waiting awhile.
9608	0002	84	The operation to change an ownership of LU is in progress.	Retry after waiting for a while.
9608	0003	84	There is no partition to which the current partition is to be changed.	Retry after waiting for a while.
9608	0004	84	The specified P-VOL or the specified S-VOL is the LU, for which a change of the cache partitions had been reserved.	Retry after releasing the reserved status.
9608	0004	84	The P-VOL is in a status other than normal and regressive.	Check the status of the LU.
9608	0005	84	The operation to change an ownership of LU is in progress.	Retry after waiting for a while.
9608	0005	84	The data pool LU being used is in a status other than normal and regressive.	Check the status of the LU.
9608	0006	84	The pair status of the P-VOL is other than SMPL, or a V-VOL does not exist.	Check the pair status of the LU.
9608	0007	84	The pair status is other than SMPL.	Check the pair status of the LU.
9608	0008	84	The specified P-VOL is a V-VOL.	Check the pair status of the LU.
9608	0009	84	The specified V-VOL is a P-VOL.	Check the pair status of the LU.
9608	000A	84	The specified LUN is not the same as the expected one.	Make sure of the specified LU.
9608	000B	84	The group ID is out of appropriate ranges.	Make sure of the specified group ID number.
9608	000D	84	The same MU number was specified within the same P-VOL.	Make sure of the specified MU number.
9608	000E	84	The process is in progress.	Retry after waiting for a while.
9608	0010	84	The pair status is other than PSUS.	Check the pair status of the LU.
9608	0011	84	The object LUN is not the same as the expected one.	Check the specified LU.
9608	0012	84	The pairsplit -E command (instruction of forced suspension) was received.	Make sure of the command.
9608	0014	84	The P-VOL is in a status other than normal or regressive.	Check the status of the LU.

Table 3-5: Sense Codes (Continued)

Sense code	Detailed code	Sub code	Error contents	Recommended Action
9608	0015	84	The data pool LU being used is in a status other than normal or regressive.	Check the status of the pool LU.
9608	0016	84	There is no V-VOL corresponding to the specified P-VOL.	Check the status of the LU.
9608	0017	84	The pair attribute of the P-VOL is V-VOL.	Check the status of the LU.
9608	0018	84	The pair attribute of the V-VOL is P-VOL.	Check the status of the LU.
9608	0019	84	The object LUN is not the same as the expected one.	Check the specified LU.
9608	001A	84	The same MU number was specified within the same P-VOL.	Make sure of the specified MU number.
9608	001B	84	The process is in progress.	Retry after waiting for a while.
9608	001D	84	The object LUN is not the same as the expected one.	Check the specified LU.
9608	001E	84	The specified V-VOL is not specified to be grouped. (Group ID suspension)	Check the pair attribute of the LU.
9608	001F	84	The V-VOL, which is an object of the batch suspension, is in a status other than PAIR. (Group ID suspension)	Check the pair status of the LU.
9608	0020	84	The process is in progress.	Retry after waiting for a while.
9608	0021	84	The process is in progress.	Retry after waiting for a while.
9608	0022	84	The pair status of the V-VOL is illegal.	Check the pair status of the LU.
9608	0023	84	The object LUN is not the same as the expected one.	Check the specified LU.
9608	0028	84	The specified MU number is different from that of the specified V-VOL.	Make sure of the specified MU number.
9608	0029	84	The specified MU number is different from that of the specified V-VOL.	Make sure of the specified MU number.
9608	002A	84	The specified MU number is different from that of the specified V-VOL.	Make sure of the specified MU number.
9608	002B	84	The pair status was changed to PSUE because the process terminated abnormally.	Place the pair concerned in the SMPL status once, and then create the pair again.
9608	002C	84	The specified P-VOL has excess pinned data (at the time of a restoration only).	Retry after eliminating pinned data.

Table 3-5: Sense Codes (Continued)

Sense code	Detailed code	Sub code	Error contents	Recommended Action
9608	002E	84	CCI was received by the control information on 8-byte form.	Check the environment of CCI.
9608	002F	84	There are 64 or more LUs being restored.	Retry after the restoration is completed.
9608	0030	84	The P-VOL is being restored.	Retry after the restoration is completed.
9608	0031	84	Data of the V-VOL is partially destroyed.	Make a backup from the S-VOL to a tape device, and so on and then restore the data to the P-VOL.
9608	0032	84	The process is in progress.	Retry after waiting for a while.
9608	0033	84	Because the process terminated abnormally, the pair status was changed to PSUE and the P-VOL became unable to accept Read/Write instructions.	Change the statuses of all V-VOLs of the P-VOL concerned to SMPL, and create the pair again.
9608	0034	84	Because the process terminated abnormally, the pair status was changed to PSUE and the P-VOL became unable to accept Read/Write instructions.	Change the statuses of all V-VOLs of the P-VOL concerned to SMPL, and create the pair again.
9608	0035	84	The MU number is other than 0 to 2.	Make sure of the specified MU number.
9608	0036	84	The MU number is other than 0 to 2.	Make sure of the specified MU number.
9608	0037	84	The MU number is other than 0.	Make sure of the specified MU number.
9608	0038	84	The V-VOL is a volume of TrueCopy and in a status other than SMPL.	Check the status of the TrueCopy pair.
9608	0039	84	The P-VOL of SnapShot is a P-VOL of TrueCopy. It is in the PSUS status and prohibited from accepting Write instructions.	Check the pair status and pair attribute.
9608	003A	84	The P-VOL of SnapShot is a P-VOL of TrueCopy. It is in the PSUS status and prohibited from accepting Write instructions.	Check the pair status and pair attribute.
9608	003B	84	The P-VOL of SnapShot is a volume of TrueCopy and it is in a status other than SMPL and PSUS.	Check the status of the TrueCopy pair.
9608	003C	84	Among the other S-VOLs of SnapShot, there are LUs of TrueCopy in a status other than PSUS and PSUE.	Check the status of the TrueCopy pair.
9608	003D	84	The V-VOL is a volume of TrueCopy and in a status other than PSUS and PSUE.	Check the status of the TrueCopy pair.

Table 3-5: Sense Codes (Continued)

Sense code	Detailed code	Sub code	Error contents	Recommended Action
9608	003E	84	The V-VOL is a volume of TrueCopy and in a status other than SMPL.	Check the status of the TrueCopy pair.
9608	0044	84	The DM-LU is not set.	Retry after setting the DM-LU.
9608	0045	84	The DM-LU was specified as P-VOL.	Check the status of the LU.
9608	0046	84	The DM-LU was specified as V-VOL.	Check the status of the LU.
9608	0047	84	The DM-LU is not set.	Retry after setting the DM-LU.
9608	0048	84	The DM-LU was specified as P-VOL.	Check the status of the LU.
9608	0049	84	The DM-LU was specified as V-VOL.	Check the status of the LU.
9608	004A	84	Validity of the license expired.	Purchase the license.
9608	004B	84	Validity of the license expired.	Purchase the license.
9608	0052	84	The specified P-VOL is a P-VOL of TCE and the status of the TCE pair is other than PSUS (at the time of restoration).	Check the status of the LU.
9608	0053	84	The specified P-VOL is an S-VOL of TCE and the status of the TCE pair is PSUS and writing to the S-VOL is prohibited (at the time of restoration).	Check the status of the LU.
9608	0054	84	The specified P-VOL is an S-VOL of TCE and the status of the TCE pair is SSWS(R) (at the time of restoration).	Check the status of the LU.
9608	0056	84	The specified P-VOL is an S-VOL of TCE and the status of the TCE pair is PSUS and reading from writing to the S-VOL is prohibited (at the time of restoration).	Check the status of the LU.
9608	0057	84	The specified P-VOL is an S-VOL of TCE and the status of the TCE pair is other than SMPL or PSUS (at the time of restoration).	Check the status of the LU.
9608	0058	84	The P-VOL of this SnapShot is the S-VOL of the TCE pair. It cannot be executed because the status of this TCE pair is COPY or PAIR.	Check the status of the LU.
9608	0059	84	The specified P-VOL is an S-VOL of TCE and the status of the TCE pair is PSUS and reading from or writing to the S-VOL is prohibited.	Check the status of the LU.
9608	005A	84	The specified P-VOL is an S-VOL of TCE and the status of the TCE pair is COPY or PAIR.	Check the status of the LU.

Table 3-5: Sense Codes (Continued)

Sense code	Detailed code	Sub code	Error contents	Recommended Action
9608	005B	84	The specified P-VOL is an S-VOL of TCE and the status of the TCE pair is PSUS and reading from writing to the S-VOL is prohibited.	Check the status of the LU.
9608	005C	84	The specified P-VOL is an S-VOL of TCE and the status of the TCE pair is PFUS (at the time of restoration).	Check the status of the LU.
9608	005D	84	The specified P-VOL is the reserved LU.	Check the status of the LU.
9608	005E	84	The specified P-VOL is the reserved LU.	Check the status of the LU.
9608	005F	84	Though the specified P-VOL requires a change of an ownership of LU, it has the pinned data.	Contact the service personnel.
9608	0060	84	The controller that controls the LU that will be the P-VOL cannot be changed.	Check the status of the LU.
9608	0061	84	The operation to change LU is in progress.	Retry after waiting for a while.
9608	0062	84	There is no partition to which the current partition to be changed.	Retry after waiting for a while.
9608	0063	84	Though the specified P-VOL requires a change of an ownership of LU, the directory structure is being changed.	Check the status of the LU.
9608	0064	84	Though the specified P-VOL requires a change of an ownership of LU, a time-out occurred in the ownership of LU changed.	Check the status of the LU.
9608	0065	84	The disk drives that configure a RAID group, to which the specified P-VOL belongs have been spun down (at the time of restoration).	Check the status of the RAID group.
9608	0066	84	The specified pool ID is beyond the limits of supported.	Check the specified pool ID.
9608	0067	84	There is no pool LU at the specified pool ID.	Check the specified pool ID.
9608	0068	84	The specified P-VOL is already paired with one or more V-VOLs, and the specified pool ID is different from the pool ID, which is already assigned.	Check the specified pool ID.
9608	0069	84	The RAID group, to which the specified P-VOL belongs, is RAID 0.	Check the RAID level of the specified LU.
9608	006A	84	The V-VOL has already created the maximum number of pairs for the specified P-VOL.	Check the number of V-VOLs which have paired with the P-VOL.

Table 3-5: Sense Codes (Continued)

Sense code	Detailed code	Sub code	Error contents	Recommended Action
9608	006B	84	The specified P-VOL is a SubLU of a unified LU.	Check the status of the LU.
9608	006C	84	The specified P-VOL is a Volume Migration pair.	Check the status of the LU.
9608	006D	84	The specified P-VOL is a ShadowImage pair.	Check the attribute of the LU.
9608	006E	84	The specified P-VOL has been defined to the command device.	Check the attribute of the LU.
9608	006F	84	The capacity of SnapShot pair is beyond the limits.	Confirm the capacity of all SnapShot P-VOLs, all P-VOLs and S-VOLs of TCE pairs, and data pools less than or equal to the supported capacity for the installed cache memory.
9608	0070	84	The process is in progress.	Retry after waiting for a while.
9608	0071	84	It is exceeded the total allowable maximum number of TCE and SnapShot pairs.	Delete the unnecessary pairs.
9608	0072	84	The specified P-VOL is a MainLU of a unified LU, which includes an LU with a capacity smaller than 1 GB.	Check the status of the LU.
9608	0073	84	The specified P-VOL has been set to the current Cache Residency LU.	Check the status of the LU.
9608	0074	84	The specified P-VOL has been set to the reserved Cache Residency LU.	Check the status of the LU.
9608	0075	84	The specified P-VOL is the LU, for which a change of the cache partitions had been reserved to other directory.	Check the status of the LU.
9608	0076	84	Differential bit map is insufficient.	Delete the unnecessary pairs.
9608	0077	84	When the specified P-VOL is a TCE pair, the specified pool ID and the used pool ID are not the same.	Check the specified pool ID.
9608	0078	84	LU capacities of the P-VOL and V-VOL are different.	Check the capacity of the LU.
9608	007B	84	An unsupported command option was received.	Check the specified value.
9608	007C	84	The specified pool ID is beyond the limits of supported.	Check the specified pool ID.
9608	007D	84	There is no pool LU at the specified pool ID.	Check the specified pool ID.

Table 3-5: Sense Codes (Continued)

Sense code	Detailed code	Sub code	Error contents	Recommended Action
9608	007E	84	An instruction to create a pair was issued to a P-VOL, which has one or more pairs, specifying a pool ID different from that has been assigned.	Check the specified pool ID.
9608	007F	84	The RAID group, to which the specified P-VOL belongs, is RAID 0.	Check the RAID level of the specified LU.
9608	0080	84	The V-VOL has already created the maximum number of pairs for the specified P-VOL.	Check the number of V-VOLs which have paired with the P-VOL.
9608	0081	84	The specified P-VOL is a SubLU of a unified LU.	Check the status of the LU.
9608	0082	84	The specified P-VOL is a Volume Migration pair.	Check the attribute of the LU.
9608	0083	84	The specified P-VOL is a ShadowImage pair.	Check the attribute of the LU.
9608	0084	84	The specified P-VOL has been defined to the command device.	Check the attribute of the LU.
9608	0085	84	The capacity of SnapShot pair is beyond the limits.	Confirm the capacity of all SnapShot P-VOLs, all P-VOLs and S-VOLs of TCE pairs, and data pools less than or equal to the supported capacity for the installed cache memory.
9608	0086	84	The process is in progress.	Retry after waiting for a while.
9608	0087	84	It is exceeded the total allowable maximum number of TCE and SnapShot pairs.	Delete the unnecessary pairs.
9608	0088	84	The specified P-VOL is a MainLU of a unified LU, which includes an LU with a capacity smaller than 1 GB.	Check the status of the LU.
9608	0089	84	The specified P-VOL has been set to the current Cache Residency LU.	Check the status of the LU.
9608	008A	84	The specified P-VOL has been set to the reserved Cache Residency LU.	Check the status of the LU.
9608	008B	84	The specified P-VOL is the LU, for which a change of the cache partitions had been reserved to other directory.	Check the status of the LU.
9608	008C	84	Differential bit map is insufficient.	Delete the unnecessary pairs.
9608	008D	84	When the specified P-VOL is a TCE pair, the specified pool ID and the used pool ID are not the same.	Check the specified pool ID.

Table 3-5: Sense Codes (Continued)

Sense code	Detailed code	Sub code	Error contents	Recommended Action
9608	008E	84	LU capacities of the P-VOL and V-VOL are different.	Check the capacity of the LU.
9608	008F	84	When creating a pair specifying a group ID, the specified group ID is already used for a ShadowImage pair.	Check the specified group ID.
9608	00A6	84	The operation cannot be performed due to insufficient capacity of the DP pool for the specified P-VOL.	Check the capacity of the DP pool.
9608	00A7	84	The operation cannot be performed due to insufficient capacity of the DP pool for the LUs which belong to data pool.	Check the capacity of the DP pool.
9608	00A8	84	Management information of Dynamic Provisioning is being updated.	Retry after waiting for a while.
9608	00A9	84	The operation cannot be performed due to insufficient capacity of the DP pool for the P-VOL of a pair in the same group.	Check the capacity of the DP pool.
9608	00AA	84	The operation cannot be performed due to insufficient capacity of the DP pool for the LU specified for data pool of a pair in the same group.	Check the capacity of the DP pool.
9608	00AB	84	The V-VOL of the specified pair is the P-VOL of a TrueCopy or TCE.	Retry after deleting the TrueCopy or TCE pair.
9608	00AC	84	Access attribute has been set to the V-VOL of the specified SnapShot pair.	Change the attribute to Read/Write and reset S-VOL Disable. If mode is set, reset it using CCI. Then, delete the pair.
9608	00AD	84	The memory reconfiguration process is in progress.	Retry after the memory reconfiguration process completes.
9608	00AE	84	The memory reconfiguration process is in progress.	Retry after the memory reconfiguration process completes.
9608	00AF	84	The full capacity mode differs between the P-VOL and data pools.	Set both P-VOL and data pools the same value.
9608	00B0	84	The full capacity mode differs between the P-VOL and data pools.	Set both P-VOL and data pools the same value.
9608	00B1	84	The status of the ShadowImage pair cascading with the specified SnapShot pair is invalid.	Check the status of the ShadowImage pair.

Table 3-5: Sense Codes (Continued)

Sense code	Detailed code	Sub code	Error contents	Recommended Action
9608	00B2	84	The status of a ShadowImage pair cascading with the specified SnapShot pair is PSUE where the ShadowImage pair cannot accept Read/Write instructions.	Check the pair status.
9608	00B3	84	The LU ownership of the specified P-VOL is different than the one of the specified data pool.	Specify another data pool or check the LU ownership.
9608	00B4	84	There is a ShadowImage pair in the specified group cascading with another pair.	Check the status of the ShadowImage pair.
9608	00B5	84	The specified MU# is invalid.	Check the MU#.
9608	00EF	84	The partition or pair partition to which the target LU belongs is incorrect.	Check the partition number.
9608	00F0	84	The firmware internal error occurred.	Retry after waiting for a while. If an error occurred again, contact the service personnel.
9608	00FA	84	The operation to change LU has become timeout while the controller is recovering.	Retry the operation after the controller is recovered.
9608	00FB	84	The RAID group to which the target LU belongs indicates a status other than Normal.	Retry after the status becomes Normal.
9608	x000	84	The controller that controls the LU cannot be changed because pinned data exists.	Retry after eliminating pinned data.
9608	x001	84	The controller that controls the LU cannot be changed temporarily.	Retry after waiting for a while.
9608	x002	84	The operation to change LU is in progress.	Retry after waiting for a while.
9608	x003	84	There is no partition to which the current partition is to be changed.	Retry after waiting for a while.
9608	x004	84	The directory configuration is being changed.	Reboot the array.
9608	x005	84	The change of a controller that controls the LU resulted in a timeout.	Retry after waiting for a while.
9608	x090	84	The partition or pair partition to which the target LU belongs is incorrect.	Check the partition number.
9608	x091	84	The firmware internal error occurred.	Retry after waiting for a while. If an error occurred again, contact the service personnel.
9609	0001	84	The target LU is undergoing the change of an ownership of LU.	Retry after waiting for a while.

Table 3-5: Sense Codes (Continued)

Sense code	Detailed code	Sub code	Error contents	Recommended Action
9609	0002	84	The target LU is undergoing the change of an ownership of LU.	Retry after waiting for a while.
9609	0003	84	An instruction to change the controller that controls the LU was issued.	Retry after waiting for a while.
9609	0004	84	The owner controller LUs to be paired is detached.	Retry.
9609	0005	84	The owner controller LUs to be paired is detached.	Retry.
9609	0006	84	The owner controller LUs to be paired is detached.	Retry.
9609	0007	84	The owner controller LUs to be paired is detached.	Retry.
9609	0009	84	The owner controller LUs to be paired is detached.	Retry after waiting for a while.
9609	000A	84	The owner controller LUs to be paired is detached.	Retry after waiting for a while.
9609	000B	84	The owner controller LUs to be paired is detached.	Retry after waiting for a while.
9609	0019	84	The pair operation commands are a time-out.	Retry after waiting for a while.
9609	0060	94	The path of the local array is abnormal.	Check the status of the path.
9609	0061	94	The path of the local array is abnormal.	Check the status of the path.
9609	0062	94	The path of the local array is abnormal.	Check the status of the path.
9609	0063	94	The path of the local array is abnormal.	Check the status of the path.
9609	0065	84	Since the specified P-VOL requires a change of an ownership of LU, it is undergoing the execution of the ownership of LU change.	Retry after waiting for a while.
9609	0066	84	Though the specified P-VOL requires a change of an ownership of LU, the controller to be changed is blocked.	Retry after waiting for a while.
9609	0067	84	Since the specified P-VOL requires a change of an ownership of LU, the execution of the ownership of LU change has been started.	Retry after waiting for a while.
9609	x001	84	The target LU is undergoing the change of an ownership of LU.	Retry after waiting for a while.
9609	x001	94	The path of the remote array was detached.	Check the status of the path.

Table 3-5: Sense Codes (Continued)

Sense code	Detailed code	Sub code	Error contents	Recommended Action
9609	x002	84	The change of a controller that controls the LU cannot be checked because the directory was blocked in the other controller.	Retry after waiting for a while.
9609	x002	94	The process is in progress.	Retry after waiting for a while.
9609	x003	84	An instruction to change the controller that controls the LU was issued.	Retry after waiting for a while.
9609	x003	94	The process is in progress.	Retry after waiting for a while.
9609	x004	94	The process is in progress.	Retry after waiting for a while.
9609	x00A	94	The remote array is receiving a command.	Retry after waiting for a while.
9609	x00F	94	The path of the remote array was detached.	Check the status of the path.
9609	x01E	94	The object LU has been organized into a TrueCopy or TCE pair, the RAID group to which the object LU belongs indicates a status other than Normal, or the process of reconfigure memory is in progress.	Check the pair status of the LU, the status of the RAID group to which the target LU belongs, and reconfigure memory status. Retry after the RAID group status becomes Normal in case that the RAID group indicate a status other than Normal. Retry after the process of reconfigure memory is completed if it is in progress.
9609	x022	94	The process is in progress.	Retry after waiting for a while.
9609	x022	94	The process is in progress.	Retry after waiting for a while.
9609	x023	94	The process is in progress.	Retry after waiting for a while.
9609	x024	94	The process is in progress.	Retry after waiting for a while.
9609	x025	94	The S-VOL of the remote array is being formatted.	Retry after waiting for a while.
9609	x026	94	The remote array is undergoing the pseudo deliberate shutdown.	Retry after the pseudo deliberate shutdown is completed.
9609	x027	94	The remote array has undergone the pseudo deliberate shutdown.	Retry after waiting for a while.
9609	x028	94	The remote array is executing a command of CCI.	Retry after waiting for a while.
9609	x029	94	A command error occurred.	Retry after waiting for a while.

Table 3-5: Sense Codes (Continued)

Sense code	Detailed code	Sub code	Error contents	Recommended Action
9609	x02A	94	The optional feature of TrueCopy or TCE of the remote array is invalid.	Unlock and validate the optional feature.
9609	x02B	94	The path of the remote array was detached.	Check the status of the path.
9609	x02C	94	The process is in progress.	Retry after waiting for a while.
9609	x02D	94	The S-VOL of the remote array is being formatted.	Retry after waiting for a while.
9609	x02E	94	The remote array is undergoing the pseudo deliberate shutdown.	Retry after the pseudo deliberate shutdown is completed.
9609	x02F	94	The remote array has undergone the pseudo deliberate shutdown.	Retry after waiting for a while.
9609	x030	94	The S-VOL is undefined.	Check the attribute of the LU.
9609	x031	94	The WWN of the remote array is illegal.	Check the array WWN.
9609	x032	94	The remote array is executing a command of CCI.	Retry after waiting for a while.
9609	x033	94	The remote array is undergoing hot replacement of the firmware.	Retry after waiting for a while.
9609	x034	94	A command error occurred.	Retry after waiting for a while.
9609	x035	94	The optional feature of TrueCopy or TCE of the remote array is locked. Otherwise, the memory configuration process is in progress on the remote array.	Unlock and enable the optional feature or retry after the memory reconfiguration process completes.
9609	x036	94	The process is in progress.	Retry after waiting for a while. If the RAID group to which the LU (that will be the S-VOL) belongs indicates a status other than Normal, retry after the status becomes Normal.

Table 3-5: Sense Codes (Continued)

Sense code	Detailed code	Sub code	Error contents	Recommended Action
9609	x037	94	The remote array is busy. Or the copy operation cannot be performed because the capacity of the DP pool is depleted or can be depleted by this copy for either the S-VOL or an S-VOL of ShadowImage cascading in the remote array. Or the status of the object LU is other than normal or regression. Or the full capacity mode is not supported.	Retry after checking the pair status of the LU, Array ID, number of the connected arrays, and group number. Or resolve the insufficient capacity of the DP pool and retry. Or make the status of the object LU normal or regression. Or check the firmware version of array.
9609	x038	94	Both of the two paths of the remote array were detached.	Check the status of the path.
9609	x039	94	The process is in progress.	Retry after waiting for a while.
9609	x03A	94	The process is in progress.	Retry after waiting for a while.
9609	x03E	94	The S-VOL command is receiving a command.	Retry after waiting for a while.
9609	x041	94	The S-VOL of the remote array is doing a duplicate writing.	Retry after waiting for a while.
9609	x042	94	The capacity is beyond the limits of supported.	Delete unnecessary pairs of the remote array.
9609	x058	94	The ShadowImage P-VOL of the remote array is in the PSUE (S-VOL Switch) status.	Contact the service personnel.
9609	x086	94	The S-VOL of the remote array is specified as a command device.	Specify a volume other than a command device of the remote array as the S-VOL.
9609	x087	94	The S-VOL of the remote array is executing format. Or management information of Dynamic Provisioning for the LU specified as S-VOL in the remote array is being updated.	Create the pair again after the quick formatting is completed. Or retry after waiting a while.
9609	x088	94	The S-VOL of the remote array is specified as the DM-LU.	Specify a volume other than the DM-LU of the remote array as the S-VOL.
9609	x089	94	The S-VOL of the remote array is in the status of S-VOL Disable.	Check the status of the remote array and cancel the access attribute.

Table 3-5: Sense Codes (Continued)

Sense code	Detailed code	Sub code	Error contents	Recommended Action
9609	x08A	94	The S-VOL in the remote array cannot be allocated the differential bit of TCE pair because the capacity is beyond the supported limit. Or the copy operation cannot be performed because the capacity of the DP pool is depleted or can be depleted by this copy for either the S-VOL or an S-VOL of ShadowImage cascading in the remote array.	Check the status of the remote array. In addition, delete unnecessary pairs of the remote array. Or resolve the insufficient capacity of the DP pool and retry.
9609	x08B	94	The capacity of TCE pair is beyond the limits within the remote array.	Confirm the capacity of all SnapShot P-VOLs, all P-VOLs and S-VOLs of TCE pairs, and data pools less than or equal to the supported capacity for the installed cache memory.
9609	x08C	94	The process is in progress.	Retry after waiting for a while.
9609	x08D	94	The S-VOL of the remote array does not meet the conditions of cascading with a SnapShot pair.	Check the status of the LU in the remote array.
9609	x08E	94	The S-VOL in the remote array has created a ShadowImage pair.	The TCE and ShadowImage volumes cannot be cascaded with each other. Check the LU status of the remote array.
9609	x091	94	The serial number of the S-VOL in the remote array is wrong.	Check the serial number of the remote array.
9609	x094	94	The RAID level of the S-VOL in the remote array is RAID 0.	Make the RAID level of the remote array other than RAID 0.
9609	x095	94	The S-VOL in the remote array is undergoing the forced parity correction.	Check the status of the remote array and retry after waiting for a while.
9609	x096	94	The S-VOL in the remote array is a SnapShot V-VOL.	The TCE and SnapShot V-VOLs cannot be cascaded with each other. Check the LU status of the remote array.
9609	x097	94	The S-VOL in the remote array received an illegal command.	Check the status of the remote array.
9609	x098	94	The S-VOL in the remote array is changing the cache partition.	Check the status of the remote array and retry after waiting for a while.

Table 3-5: Sense Codes (Continued)

Sense code	Detailed code	Sub code	Error contents	Recommended Action
9609	x09A	94	The LU status of the S-VOL in the remote array is normal or other than regressed, or the RAID group to which the LU belongs indicates a status other than Normal or the LU is created in the DP pool.	Check the LU status of the remote array. If the RAID group status is other than Normal, retry after status becomes Normal again. Specify an LU other than an LU created in DP pool to S-VOL.
9609	x09C	94	The LU capacity of the S-VOL in the remote array is not the same as the P-VOL capacity. Or the full capacity mode differs between the P-VOL and S-VOL. Or the full capacity mode is not supported.	Make the LU capacity of the remote array the same as that of the P-VOL. Or set both P-VOL and S-VOL the same value. Or check the firmware version of array.
9609	x09D	94	The S-VOL in the remote array is set to a Cache Residency LU.	Specify an LU other than a Cache Residency LU of the remote array.
9609	x09E	94	An LU with a capacity less than 1 GB is included in the LUs in which the S-VOL is unified in the remote array.	Check the status of the unified LU of the remote array.
9609	x09F	94	This operation cannot be executed due to lack of resources within the remote array. Retry after waiting for a while.	Check the pool LU status of the remote array.
9609	x0A0	94	The remote array has no pool LU.	Make a pool LU for the remote array.
9609	x0A1	94	The LU specified as the S-VOL in the remote array is a pool LU.	The pool LU cannot be set to an S-VOL. Check the pool LU status of the remote array.
9609	x0A2	94	The LU status of the pool LU in the remote array is normal or other than regressed.	Check the pool LU status of the remote array.
9609	x0A3	94	The pool LU in the remote array is undergoing the forced parity correction. Or the full capacity mode differs between the target LU and data pools.	Check the pool LU status of the remote array and retry after waiting for a while. Or set both target LU and data pools the same value.
9609	x0A4	94	The S-VOL in the remote array exceeded the total allowable maximum number of TCE and SnapShot pairs.	Check the status of the remote array. In addition, delete unnecessary pairs of the remote array.
9609	x0A5	94	The TCE pair status of the S-VOL in the remote array is PSUE.	Check the TCE pair status of the remote array.
9609	x0A6	94	The TCE pair status of the S-VOL in the remote array is PFUS.	Check the TCE pair status of the remote array.

Table 3-5: Sense Codes (Continued)

Sense code	Detailed code	Sub code	Error contents	Recommended Action
9609	x0A7	94	The TCE pair status of the S-VOL in the remote array is PSUS (no reading or writing allowed).	Check the TCE pair status of the remote array.
9609	x0A8	94	The TCE pair status of the S-VOL in the remote array is SSWS (including SSWS(R)).	Check the TCE pair status of the remote array.
9609	x0A9	94	The TCE pair status of the S-VOL in the remote array is SMPL.	Check the TCE pair status of the remote array.
9609	x0AA	94	The TCE pair status of the S-VOL in the remote array is PSUS.	Check the TCE pair status of the remote array.
9609	x0AB	94	The TCE pair status of the S-VOL in the remote array is not SMPL.	Check the TCE pair status of the remote array.
9609	x0B4	94	The S-VOL in the remote array does not exist on the default owner controller and, at the same time, the special processing cannot be continued.	Check the status of the remote array and retry after waiting for a while.
9609	x0B5	94	The S-VOL in the remote array does not exist on the default owner controller and, at the same time, an ownership of LU change for it has been started.	Check the status of the remote array and retry after waiting for a while.
9609	x0B6	94	The S-VOL in the remote array does not exist on the default owner controller and it has started an ownership of LU change.	Check the status of the remote array and retry after waiting for a while.
9609	x0B7	94	The S-VOL in the remote array does not exist on the default owner controller and, at the same time, an ownership of LU to be changed is blocked.	Check the status of the remote array and retry after waiting for a while.
9609	x0B8	94	The S-VOL in the remote array cannot change an ownership of LU and, at the same time, it is using the sequential buffer.	Check the status of the remote array and retry after waiting for a while.
9609	x0B9	94	The S-VOL in the remote array cannot change an ownership of LU temporarily.	Retry after waiting for a while.
9609	x0BA	94	The S-VOL in the remote array cannot change an ownership of LU and, at the same time, it has pinned data.	Contact the service personnel.
9609	x0BB	94	The S-VOL in the remote array cannot change an ownership of LU temporarily.	Retry after waiting for a while.
9609	x0BC	94	The S-VOL in the remote array cannot change an ownership of LU temporarily.	Retry after waiting for a while.

Table 3-5: Sense Codes (Continued)

Sense code	Detailed code	Sub code	Error contents	Recommended Action
9609	x0BD	94	The S-VOL in the remote array cannot change an ownership of LU and a time-out occurred.	Check the status of the remote array and retry after waiting for a while.
9609	x0BE	94	The S-VOL in the remote array cannot change an ownership of LU and, at the same time, the CTG# is illegal.	Check the status of the remote array.
9609	x0C0	94	The S-VOL in the remote array does not exist on the default owner controller and, at the same time, its disk drives are being spun up.	Check the status of the remote array and retry after waiting for a while.
9609	x0C1	94	The S-VOL in the remote array does not exist on the default owner controller and, at the same time, it is making the system copy.	Check the status of the remote array and retry after waiting for a while.
9609	x0C2	94	The S-VOL in the remote array does not exist on the default owner controller and, at the same time, it is writing the takeover information.	Check the status of the remote array and retry after waiting for a while.
9609	x0C5	94	The cycle time that has been set for the remote array is less than the minimum interval.	Check the cycle time that has been set for the remote array.
9609	x0D9	94	The status of the remote array is in an inappropriate condition to operate the TrueCopy pair.	Check the Array ID, pair status of local and remote replication, status of the RAID group to which the target LU belongs, and reconfigure memory status. Retry after waiting the RAID group status becomes Normal in case that the RAID group indicate a status other than Normal. Retry after the process of reconfigure memory is completed if it is in progress.
9609	x0E0	94	Auto Migration is being executed in the remote array just now.	Execute again after the Migration is completed.
9609	x0E5	94	The RAID group, in which the LU belongs that will be specified to the S-VOL of the remote array, indicates a status other than Normal.	Retry when the status becomes Normal.
9609	x0EA	94	The LU created in DP pool was specified as S-VOL.	Specify an LU other than the LU created in DP pool.
9609	x0EA	94	Management information of Dynamic Provisioning for the LU specified as S-VOL in the remote array is being updated.	Retry after waiting a while.

Table 3-5: Sense Codes (Continued)

Sense code	Detailed code	Sub code	Error contents	Recommended Action
9609	x0EA	94	The copy operation cannot be performed because the capacity of the DP pool is depleted or can be depleted by this copy for either the S-VOL or an S-VOL of ShadowImage cascading in the remote array.	Resolve the insufficient capacity of the DP pool and retry.
9609	x0F2	94	The process of reconfigure memory is in progress on the remote array.	Retry after the process of reconfigure memory is completed.
9609	x0F3	94	The memory reconfiguration process is in progress on the remote array.	Retry after the memory reconfiguration process completes.
9609	x0F6	94	The full capacity mode differs between the P-VOL and S-VOL. Or the full capacity mode is not supported.	Set both P-VOL and S-VOL the same value. Or check the firmware version of array.
9609	x0F8	94	The full capacity mode differs between the target LU and data pools.	Set both target LU and data pools the same value.
960A			The illegal operation was specified to a data pool LU.	Check the attribute of the LU.
9611	0001	84	The object LU is an invalidated one.	Check the status of the LU.
9611	0002	84	The object LU is a SubLU of a unified LU.	Check the status of the LU.
9611	0003	84	The S-VOL Disable was specified for the S-VOL of ShadowImage.	Check the pair status of the LU.
9611	0004	84	The S-VOL Disable was specified for the ShadowImage P-VOL that was undergoing a reverse resynchronization.	Check the pair status of the LU.
9611	0005	84	The S-VOL Disable was specified for the S-VOL of TrueCopy.	Check the pair status of the LU.
9611	0006	84	The access attribute cannot be changed because it is within the Retention Term.	–
9611	0007	84	The S-VOL Disable was specified for the V-VOL of SnapShot.	Check the pair attribute of the LU.
9611	0008	84	The S-VOL Disable was specified for the SnapShot P-VOL that was being restored.	Check the pair attribute of the LU.
9611	0009	84	The Retention Term cannot be made shorter than the current one.	–

Table 3-5: Sense Codes (Continued)

Sense code	Detailed code	Sub code	Error contents	Recommended Action
9611	000A	84	The access attribute cannot be changed because the Expiration Lock is turned on.	–
9611	000B	84	The Retention Term is beyond the limits of validity.	Check that the specified value that has been set is 0 to 21900.
9611	000C	84	The S-VOL Disable was specified for a ShadowImage S-VOL that is in a status other than SMPL and PSUS.	Check the pair attribute of the LU.
9611	000D	84	The S-VOL Disable was specified for a TrueCopy S-VOL that is in a status other than SMPL and PSUS.	Check the pair attribute of the LU.
9611	000E	84	The S-VOL Disable was specified for a SnapShot V-VOL that is in a status other than SMPL and PSUS.	Check the pair attribute of the LU.
9611	000F	84	Because the term of validity of the temporary key was expired, the setting of the access level that turns on the Write Inhibit cannot be made.	Check the term of validity of the license key, or use the Data Retention function with the permanent key.
9611	0010	84	The target LU is defined as the DM-LU.	Check the attribute of the LU.
9611	0013	84	The specified LU is an S-VOL of TCE that status is other than SMPL or PSUS.	Check the attribute of the LU.
9611	0014	84	The specified LU is an S-VOL of Volume Migration.	Check the status of the LU.
9611	0015	84	The specified LU is the reserve LU.	Check the status of the LU.
9611	0016	84	The data migration status is "data is being copied", "data copy fails", or "data copy is completed".	Check the data migration status.
9611	0017	84	The data migration status is "access path is being switched" or "access path switching fails".	Check the data migration status.
9611	0018	84	The specified LU cannot set the Write prohibition attribute because of S-VOL of PSUS(SP) of ShadowImage.	Check the status of the LU.
9611	0019	84	The LU created in DP pool was specified.	Specify an LU other than the LU created in DP pool.
9612	0001	84	The P-VOL or S-VOL is being formatted.	Retry after the formatting is completed.
9612	0002	84	The P-VOL or S-VOL is being formatted.	Retry after the formatting is completed.
9612	0003	84	The P-VOL or S-VOL is being formatted.	Retry after the formatting is completed.
9612	0004	84	The P-VOL or S-VOL is being formatted.	Retry after the formatting is completed.

Table 3-5: Sense Codes (Continued)

Sense code	Detailed code	Sub code	Error contents	Recommended Action
9612	0005	84	The P-VOL or S-VOL is being formatted.	Retry after the formatting is completed.
9613	0001	84	The S-VOL is in the S-VOL Disable mode.	Cancel the access attribute.
9613	0002	84	The P-VOL is in the S-VOL Disable mode (at the time of a restoration).	Cancel the access attribute.
9613	0003	84	The S-VOL Disable is specified for the P-VOL (at the time of a restoration only).	Cancel the access attribute.
9613	0004	84	The S-VOL Disable is specified for the S-VOL.	Cancel the access attribute.
9613	0005	84	Resynchronization is directed to the ShadowImage pair whose S-VOL is specified as S-VOL Disable.	Check the attribute of the LU.
9613	0006	84	The S-VOL Disable is specified for the S-VOL (at the time of a restoration only).	Cancel the access attribute.
9618	0001	84	The P-VOL or S-VOL has not undergone the forced restoration by means of parity.	Retry after making the restoration by means of parity.
9618	0002	84	The P-VOL is undergoing the forced restoration by means of parity (at the time of a restoration).	Retry after the restoration by means of parity is completed.
9618	0003	84	The S-VOL is undergoing the forced restoration by means of parity.	Retry after making the restoration by means of parity.
9618	0011	84	The P-VOL has not undergone the forced restoration by means of parity.	Retry after making the restoration by means of parity.
9618	0012	84	The P-VOL is undergoing the forced restoration by means of parity.	Retry after the restoration by means of parity is completed.
9618	0021	84	The P-VOL or data pool LU has not undergone the forced restoration by means of parity.	Retry after making the restoration by means of parity.
9618	0022	84	The P-VOL is undergoing the forced restoration by means of parity (at the time of a restoration).	Retry after the restoration by means of parity is completed.
9618	0023	84	The data pool LU is undergoing the forced restoration by means of parity.	Retry after the restoration by means of parity is completed.
961C	0001	84	More LUs than supportable ones were specified for LUNs of the P-VOL.	Make sure of the number of the specified paired LU.

Table 3-5: Sense Codes (Continued)

Sense code	Detailed code	Sub code	Error contents	Recommended Action
961C	0002	84	More LUs than supportable ones were specified for LUNs of the S-VOL.	Make sure of the number of the specified paired LU.
961C	0003	84	The P-VOL is in the status other than normal or regressive.	Check the status of the LU.
961C	0004	84	The S-VOL is in the status other than normal or regressive.	Check the status of the LU.
961C	0005	84	The primary sequence number is different from the own Array ID.	Check the Array ID.
961C	0006	84	The secondary sequence number is different from the own Array ID.	Check the Array ID.
961C	0007	84	The primary port number is not supported.	Check the specified port number.
961C	0008	84	The secondary port number is not supported.	Check the specified port number.
961C	0009	84	The P-VOL is a volume of ShadowImage and in the status other than SMPL.	Check the pair status of the LU.
961C	000A	84	The S-VOL is a volume of ShadowImage and in the status other than SMPL.	Check the pair status of the LU.
961C	000B	84	The P-VOL is a Sub LU of a unified LU.	Check the status of the LU.
961C	000C	84	The S-VOL is a Sub LU of a unified LU.	Check the status of the LU.
961C	000E	84	The P-VOL is a Cache Residency LU.	Check the status of the LU.
961C	000F	84	The S-VOL is a Cache Residency LU.	Check the status of the LU.
961C	0010	84	The P-VOL is reserved as a Cache Residency LU.	Check the status of the LU.
961C	0011	84	The S-VOL is reserved as a Cache Residency LU.	Check the status of the LU.
961C	0012	84	The P-VOL is a command device.	Check the status of the LU.
961C	0013	84	The S-VOL is a command device.	Check the status of the LU.
961C	0014	84	The LUNs of the P-VOL and S-VOL are the same.	Check the specified LU.
961C	0015	84	The P-VOL is a volume of ShadowImage and in the pair status other than PSUS or PSUE.	Check the pair status.
961C	0016	84	The S-VOL is a volume of ShadowImage and in the pair status other than PSUS or PSUE.	Check the pair status.
961C	0017	84	The LU to be paired with the P-VOL is not an S-VOL.	Check the specified LU.
961C	0018	84	The LUN of the P-VOL is higher than 512 (1,023).	Make sure of the number of the specified paired LU.

Table 3-5: Sense Codes (Continued)

Sense code	Detailed code	Sub code	Error contents	Recommended Action
961C	0019	84	The LUN of the S-VOL is higher than 512 (1,023).	Make sure of the number of the specified paired LU.
961C	001A	84	The primary sequence number is different from the own Array ID.	Check the Array ID.
961C	001B	84	The secondary sequence number is different from the own Array ID.	Check the Array ID.
961C	001C	84	The primary port number is not supported.	Check the specified port number.
961C	001D	84	The secondary port number is not supported.	Check the specified port number.
961C	001E	84	The P-VOL is a volume of ShadowImage and in the pair status of SMPL or PSUE.	Check the pair status of the LU.
961C	001F	84	The S-VOL is a volume of ShadowImage and in the pair status of SMPL or PSUE.	Check the pair status of the LU.
961C	0020	84	The LU to be paired with the P-VOL is not an S-VOL.	Check the specified LU.
961C	0021	84	The status of the P-VOL is other than normal or regressive.	Check the status of the LU.
961C	0022	84	The status of the S-VOL is other than normal or regressive.	Check the status of the LU.
961C	0023	84	The P-VOL is a Sub LU of a unified LU.	Check the status of the LU.
961C	0024	84	The S-VOL is a Sub LU of a unified LU.	Check the status of the LU.
961C	0026	84	The P-VOL has been set to the current Cache Residency LU.	Check the status of the LU.
961C	0027	84	The S-VOL has been set to the current Cache Residency LU.	Check the status of the LU.
961C	0028	84	The P-VOL is reserved as a Cache Residency LU.	Check the status of the LU.
961C	0029	84	The S-VOL is reserved as a Cache Residency LU.	Check the status of the LU.
961C	002A	84	The P-VOL is defined as a command device.	Check the status of the LU.
961C	002B	84	The S-VOL is defined as a command device.	Check the status of the LU.
961C	002C	84	The LUNs of the P-VOL and S-VOL are the same.	Check the specified LU.
961C	002D	84	The number of the LU to be paired is different.	Check the specified LUN.
961C	002E	84	The number of the LU to be paired is different.	Check the specified LUN.
961C	002F	84	The pair status of the P-VOL/S-VOL is other than SMPL, PAIR, or COPY.	Check the pair status of the LU.

Table 3-5: Sense Codes (Continued)

Sense code	Detailed code	Sub code	Error contents	Recommended Action
961C	0030	84	The LUN of the P-VOL is beyond the limits of support.	Check the specified LUN.
961C	0031	84	The LUN of the S-VOL is beyond the limits of support.	Check the specified LUN.
961C	0032	84	The pair attribute of the LU specified for a P-VOL is not a P-VOL.	Check the specified LUN.
961C	0033	84	The number of the LU to be paired is different.	Check the specified LUN.
961C	0034	84	The primary sequence number is different from the Array ID.	Check the specified primary sequence number.
961C	0035	84	The secondary sequence number is different from the Array ID.	Check the specified secondary sequence number.
961C	0036	84	The primary port number is beyond the limits of support.	Check the specified primary port number.
961C	0037	84	The secondary port number is beyond the limits of support.	Check the specified secondary port number.
961C	0038	84	A pair in the PSUE (S-VOL Switch) status received an instruction to restore.	Request that service personnel replace the drives that compose the P-VOL. Format them after the replacement, then resynchronize them.
961C	0039	84	The specified pair is in the PSUE (S-VOL Switch) status.	Request that service personnel replace the drives that compose the P-VOL. Format them after the replacement, then resynchronize them.
961C	003A	84	The pair in the PSUE (S-VOL Switch) status is undergoing resynchronization.	Wait until the resynchronization is completed.
961C	003B	84	The pair in the PSUE (S-VOL Switch) status is undergoing resynchronization.	Wait until the resynchronization is completed.
961C	003C	84	The group ID is out of appropriate ranges.	Make sure of the specified group ID number.
961C	003D	84	The number of pairs having the same group ID exceeded 32.	Make sure of the specified group ID number.
961C	003E	84	The specified P-VOL/S-VOL is not specified to be grouped. (Group ID suspension)	Check the pair status of the LU.
961C	003F	84	The P-VOL/S-VOL, which is the object of the batch suspension, is in a status other than PAIR. (Group ID suspension)	Check the pair status of the LU.
961C	0046	84	The DM-LU is not set.	Retry after setting the DM-LU.

Table 3-5: Sense Codes (Continued)

Sense code	Detailed code	Sub code	Error contents	Recommended Action
961C	0047	84	The DM-LU was specified as P-VOL.	Check the status of the LU.
961C	0048	84	The DM-LU was specified as S-VOL.	Check the status of the LU.
961C	004B	84	The DM-LU is not set.	Retry after setting the DM-LU.
961C	004C	84	The DM-LU was specified as P-VOL.	Check the status of the LU.
961C	004D	84	The DM-LU was specified as S-VOL.	Check the status of the LU.
961C	004E	84	Validity of the license expired.	Purchase the license.
961C	004F	84	Validity of the license expired.	Purchase the license.
961C	0050	84	An LU, for which a change of the cache partitions had been reserved, was specified as a P-VOL.	Check the status of the LU.
961C	0051	84	An LU, for which a change of the cache partitions had been reserved, was specified as a S-VOL.	Check the status of the LU.
961C	0052	84	An LU, for which a change of the cache partitions had been reserved, was specified as a P-VOL.	Check the status of the LU.
961C	0053	84	An LU, for which a change of the cache partitions had been reserved, was specified as a S-VOL.	Check the status of the LU.
961C	005E	84	The specified P-VOL is a TCE pair.	Check the status of the LU.
961C	005F	84	The specified S-VOL is a TCE pair.	Check the status of the LU.
961C	0060	84	The specified P-VOL is a TCE pair.	Check the status of the LU.
961C	0061	84	The specified S-VOL is a TCE pair.	Check the status of the LU.
961C	0064	84	The specified MU# is used within the specified P-VOL.	Check the specified MU number.
961C	0065	84	One or more volumes of PAIR/COPY/RCOPY are under the specified P-VOL.	Check the pair status of the LU.
961C	0066	84	One or more volumes of special PSUE are under the specified P-VOL.	Check the pair status of the LU.
961C	0067	84	One or more PSUE pairs that are not readable or writable (PSUE transition due to a failure during the restoration) under the specified P-VOL.	Check the pair status of the LU.

Table 3-5: Sense Codes (Continued)

Sense code	Detailed code	Sub code	Error contents	Recommended Action
961C	0068	84	The group ID overlaps within the specified P-VOL at the time of creating the pair of which the group is specified.	Make sure of the specified group ID number.
961C	0069	84	The pair attribute of the specified P-VOL is not a P-VOL or the pair attribute of the specified S-VOL is not a S-VOL.	Check the pair attribute of the LU.
961C	006A	84	The specified MU# and the MU# of the specified P-VOL are mismatched.	Check the specified MU number.
961C	006B	84	One or more volumes of PAIR/COPY/RCOPY are under the specified P-VOL.	Check the pair status of the LU.
961C	006C	84	One or more PSUE pairs that are not readable or writable (PSUE transition due to a failure during the restoration) under the specified P-VOL.	Check the pair status of the LU.
961C	006D	84	The pair attribute of the specified P-VOL is not a P-VOL or the pair attribute of the specified S-VOL is not a S-VOL.	Check the pair attribute of the LU.
961C	006E	84	The specified MU# and the MU# of the specified S-VOL are mismatched.	Check the specified MU number.
961C	006F	84	The specified MU# and the MU# of the specified S-VOL are mismatched.	Check the specified MU number.
961C	0070	84	The specified MU# is used within the specified P-VOL.	Check the specified MU number.
961C	0071	84	One or more volumes of PAIR/COPY/RCOPY are under the specified P-VOL.	Check the pair status of the LU.
961C	0072	84	One or more volumes of special PSUE are under the specified P-VOL.	Check the pair status of the LU.
961C	0073	84	One or more PSUE pairs that are not readable or writable (PSUE transition due to a failure during the restoration) under the specified P-VOL.	Check the pair status of the LU.
961C	0074	84	The specified MU# and the MU# of the specified S-VOL are mismatched.	Check the specified MU number.
961C	0075	84	The specified MU# and the MU# of the specified S-VOL are mismatched.	Check the specified MU number.

Table 3-5: Sense Codes (Continued)

Sense code	Detailed code	Sub code	Error contents	Recommended Action
961C	0077	84	The specified P-VOL is the reserved LU.	Check the status of the LU.
961C	0078	84	The specified S-VOL is the reserved LU.	Check the status of the LU.
961C	0079	84	The specified S-VOL is undergoing the migration and its status is PSUS or PSUE.	Check the pair status of the LU.
961C	0080	84	The specified S-VOL is undergoing the migration and its status is COPY or PSUS.	Check the pair status of the LU.
961C	0081	84	The specified P-VOL is the reserved LU.	Check the pair status of the LU.
961C	0082	84	The specified S-VOL is the reserved LU.	Check the pair status of the LU.
961C	0083	84	The specified S-VOL is undergoing the migration and its status is COPY.	Check the pair status of the LU.
961C	0084	84	The specified volume is undergoing the migration.	Check the pair status of the LU.
961C	0085	84	The specified P-VOL is undergoing the migration.	Check the pair status of the LU.
961C	0086	84	The disk drives that configure a RAID group, to which the specified P-VOL belongs have been spun down.	Check the status of the RAID group.
961C	0087	84	The disk drives that configure a RAID group, to which the specified S-VOL belongs have been spun down.	Check the status of the RAID group.
961C	0088	84	The disk drives that configure a RAID group, to which the specified P-VOL belongs have been spun down.	Check the status of the RAID group.
961C	0089	84	The disk drives that configure a RAID group, to which the specified S-VOL belongs have been spun down.	Check the status of the RAID group.
961C	008A	84	The disk drives that configure a RAID group, to which the specified P-VOL belongs have been spun down.	Check the status of the RAID group.
961C	008B	84	The disk drives that configure a RAID group, to which the specified S-VOL belongs have been spun down.	Check the status of the RAID group.
961C	008C	84	When creating a pair specifying a group ID, the specified group ID is already used for a SnapShot pair.	Check the specified group ID.

Table 3-5: Sense Codes (Continued)

Sense code	Detailed code	Sub code	Error contents	Recommended Action
961C	008C	84	The S-VOL is a volume of Remote Replication and in a status other than Split and Failure.	Check the status of the Remote Replication pair.
961C	008F	84	An unsupported command option was received.	Check the specified value.
961C	0090	84	The specified P-VOL has been set to a ShadowImage S-VOL.	Check the status of the LU.
961C	0091	84	The specified P-VOL has been set to a ShadowImage S-VOL.	Check the status of the LU.
961C	0092	84	The Migration status is other than unexecuted.	Check the Migration status.
961C	0093	84	The Migration status is other than unexecuted.	Check the Migration status.
961C	0094	84	The Migration status is other than unexecuted.	Check the Migration status.
961C	0095	84	The Migration status is other than unexecuted.	Check the Migration status.
961C	0096	84	The Migration status is other than unexecuted.	Check the Migration status.
961C	0097	84	The Migration status is other than unexecuted.	Check the Migration status.
961C	0098	84	When the Inquiry Serial Number Conversion Mode is ON in the host group that the command device is mapped, the serial number of the received remote side array is the normal specification.	Check the remote array type.
961C	0099	84	When the Inquiry Serial Number Conversion Mode is ON in the host group that the command device is mapped, the serial number of the received remote side array is the normal specification.	Check the remote array type.
961C	009A	84	The Migration status is other than unexecuted.	Check the Migration status.
961C	009B	84	One or more volumes of PSUS(SP) or PAIR(IS) are under the specified P-VOL.	Check the LU pair status.
961C	009C	84	The S-VOL of the specified pair is a volume of another TrueCopy or TCE pair.	Check the LU status.
961C	009D	84	One or more volumes of PSUS(SP) or PAIR(IS) are under the specified P-VOL.	Check the LU pair status.
961C	009E	84	The specified pair is in the PSUS(SP) status.	Retry after the status becomes PSUS.

Table 3-5: Sense Codes (Continued)

Sense code	Detailed code	Sub code	Error contents	Recommended Action
961C	009F	84	A pair in the PSUE status received an instruction to resynchronize with Quick mode.	Request service personnel to replace the drives that compose the P-VOL. Format them after the replacement, then resynchronize them.
961C	00A0	84	One or more PSUE pairs that are not readable or writable under the specified P-VOL.	Check the LU pair status.
961C	00A1	84	The capacity is beyond the limits of support.	Split the unnecessary pairs.
961C	00A2	84	The S-VOL of the specified pair has been cascaded with a TrueCopy or TCE pair.	Check the status of the TrueCopy or TCE pair.
961C	00A3	84	The P-VOL or the S-VOL has not undergone the forced restoration by means of parity.	Retry after making the restoration by means of parity.
961C	00A4	84	The S-VOL is undergoing the forced restoration by means of parity.	Retry after making the restoration by means of parity.
961C	00A5	84	The disk drives that configure a RAID group to which the specified P-VOL belongs have been spun down.	Check the status of the RAID group.
961C	00A6	84	The disk drives that configure a RAID group to which the specified S-VOL belongs have been spun down.	Check the status of the RAID group.
961C	00A7	84	A pair that is in a status other than PAIR, PAIR(IS), or COPY is included in the specified group.	Check the LU pair status in the group.
961C	00A8	84	A pair that shares the P-VOL with another pair that is in PSUE status that are not readable or writable is included in the specified group.	Check the LU pair status in the group.
961C	00A9	84	The capacity is beyond the limits of support.	Split the unnecessary pairs.
961C	00AA	84	A pair that the S-VOL has been cascaded with a TrueCopy or TCE pair is included in the specified group.	Check the status of the TrueCopy or TCE pair.
961C	00AB	84	A pair that the P-VOL or the S-VOL has not undergone the forced restoration by means of parity is included in the specified group.	Retry after making the restoration by means of parity.
961C	00AC	84	A pair that the S-VOL is undergoing the forced restoration by means of parity is included in the specified group.	Retry after making the restoration by means of parity.

Table 3-5: Sense Codes (Continued)

Sense code	Detailed code	Sub code	Error contents	Recommended Action
961C	00AD	84	A pair belonging to the P-VOL of a RAID group configured by the disk drives that have been spun down is in the specified group.	Check the RAID group status.
961C	00AE	84	A pair belonging to the S-VOL of a RAID group configured by the disk drives that have been spun down is in the specified group.	Check the RAID group status.
961C	00AF	84	One or more volumes of PSUS(SP) or PAIR(IS) are under the specified P-VOL.	Check the LU pair status.
961C	00B0	84	The P-VOL or the S-VOL of the specified pair is a volume of another TrueCopy or TCE pair.	Check the status of the TrueCopy or TCE pair.
961C	00B1	84	The specified pair is in the PSUS(SP) status.	Check the LU pair status.
961C	00B2	84	The RAID group to which the specified LU belongs indicates a status other than Normal.	Retry after the status becomes Normal.
961C	00B3	84	An LU that belongs to the RAID group that indicates a status other than Normal is included in the specified group.	Retry after the RAID group status becomes Normal.
961C	00B4	84	The specified pair is in a status other than PSUS or PSUE.	Check the pair status.
961C	00B5	84	The LU that was specified as P-VOL does not exist.	Check the specified LUN.
961C	00B6	84	The LU that was specified as P-VOL does not exist.	Check the specified LUN.
961C	00B7	84	The LU that was specified as S-VOL does not exist.	Check the specified LUN.
961C	00B8	84	The LU that was specified as S-VOL does not exist.	Check the specified LUN.
961C	00B9	84	DP pool is insufficient.	Confirm the capacity of DP pool.
961C	00BA	84	DP pool is insufficient.	Confirm the capacity of DP pool.
961C	00BB	84	DP pool is insufficient.	Confirm the capacity of DP pool.
961C	00BC	84	DP pool is insufficient.	Confirm the capacity of DP pool.
961C	00BD	84	The specified P-VOL is a volume of TrueCopy pair and the specified S-VOL is an LU created in DP pool.	Specify an LU other than the LU created in DP pool to S-VOL.
961C	00BE	84	The specified P-VOL is a volume of TrueCopy pair and the specified S-VOL is an LU created in DP pool.	Specify an LU other than the LU created in DP pool to S-VOL.

Table 3-5: Sense Codes (Continued)

Sense code	Detailed code	Sub code	Error contents	Recommended Action
961C	00BF	84	The specified S-VOL is an LU created in a DP pool, and the specified P-VOL already has a pair whose S-VOL is a part of a TrueCopy pair.	Retry after deleting the TrueCopy pair.
961C	00C0	84	The specified S-VOL is an LU created in DP pool and the specified P-VOL already has a pair whose S-VOL is a part of the TrueCopy pair.	Retry after deleting the TrueCopy pair.
961C	00C1	84	The DP optimization status of the specified P-VOL is not Normal.	Check the DP optimization status of the P-VOL.
961C	00C2	84	The DP optimization status of the specified S-VOL is not Normal.	Check the DP optimization status of the S-VOL.
961C	00C3	84	The DP optimization status of the specified P-VOL is not Normal.	Check the DP optimization status of the P-VOL.
961C	00C4	84	The DP optimization status of the specified S-VOL is not Normal.	Check the DP optimization status of the S-VOL.
961C	00C5	84	Management information regarding DP is being updated.	Retry after waiting for a while.
961C	00C6	84	Management information regarding DP is being updated.	Retry after waiting for a while.
961C	00C7	84	Management information regarding DP is being updated.	Retry after waiting for a while.
961C	00C8	84	Management information regarding DP is being updated.	Retry after waiting for a while.
961C	00C9	84	The specified P-VOL cannot be read due to insufficient capacity of its DP pool.	Check the DP Pool capacity.
961C	00CA	84	The specified P-VOL cannot be read due to insufficient capacity of its DP pool.	Check the DP Pool capacity.
961C	00CB	84	The specified S-VOL cannot be read due to insufficient capacity of its DP pool.	Check the DP Pool capacity.
961C	00CC	84	The specified P-VOL cannot be read due to insufficient capacity of its DP pool.	Check the DP Pool capacity.
961C	00CD		The memory reconfiguration process is in progress.	Retry after the memory reconfiguration process completes.
961C	00CE		The memory reconfiguration process is in progress.	Retry after the memory reconfiguration process completes.
961C	00CF	84	One or more volumes of RCPY are under the specified P-VOL.	Check the pair status of the LU.

Table 3-5: Sense Codes (Continued)

Sense code	Detailed code	Sub code	Error contents	Recommended Action
961C	00D0	84	Three or more volumes of PAIR/COPY/PAIR(IS)/PSUS(SP) cannot exist under the specified P-VOL.	Check the pair status of the LU.
961C	00D1	84	One or more volumes of RCPY are under the specified P-VOL.	Check the pair status of the LU.
961C	00D2	84	Three or more volumes of PAIR/COPY/PAIR(IS)/PSUS(SP) cannot exist under the specified P-VOL.	Check the pair status of the LU.
961C	00D3	84	Two or more volumes of PSUS(SP) cannot exist under the specified P-VOL.	Check the pair status of the LU.
961C	00D4	84	Two or more volumes of PSUS(SP) cannot exist under the specified P-VOL.	Check the pair status of the LU.
961C	00D5	84	Two or more volumes of PSUS(SP) cannot exist under the specified P-VOL.	Check the pair status of the LU.
961C	00D6	84	Two or more volumes of PSUS(SP) cannot exist under the specified P-VOL.	Check the pair status of the LU.
961C	00D7	84	The full capacity mode differs between the P-VOL and S-VOL.	Set both P-VOL and S-VOL the same value.
961C	00D9	84	The status of the SnapShot pair cascading with the specified ShadowImage pair is invalid.	Check the status of the SnapShot pair.
961C	00DA	84	The status of a SnapShot pair cascading with the specified ShadowImage pair is PSUE where the SnapShot pair cannot accept Read/Write instructions.	Check the pair status.
961C	00DB	84	The specified LU is a V-VOL.	Check the LU.
961C	00DC	84	The specified S-VOL is the P-VOL of a SnapShot pair.	Check the pair status.
961C	00DD	84	The specified P-VOL already has the maximum number of S-VOLs.	Check the number of S-VOL paired with the P-VOL.
961C	00DE	84	Any pair operations cannot be performed due to the status of the TrueCopy pair cascading with the S-VOL of the SnapShot pair that shared P-VOL of the specified ShadowImage pair.	Check the TrueCopy pair status.
9622	0001	84	The specified P-VOL is normal or other than regressed.	Check the status of the LU.
9622	0002	84	The specified P-VOL has been set to the current Cache Residency LU.	Check the attribute of the LU.
9622	0003	84	The specified P-VOL has been set to the reserved Cache Residency LU.	Check the attribute of the LU.

Table 3-5: Sense Codes (Continued)

Sense code	Detailed code	Sub code	Error contents	Recommended Action
9622	0004	84	The specified P-VOL has been defined to the command device.	Check the attribute of the LU.
9622	0005	84	The accepted sequence number is different from the Array ID.	Check the Array ID.
9622	0006	84	Both of the two paths are abnormal.	Check the status of the path.
9622	0007	84	The specified P-VOL is a Sub LU of a unified LU.	Check the attribute of the LU.
9622	0009	84	The status of the TCE pair of the specified P-VOL is other than SMPL.	Check the pair status of the LU.
9622	000A	84	The specified P-VOL is a ShadowImage pair.	Check the attribute of the LU.
9622	000B	84	The specified P-VOL is a SnapShot V-VOL.	Check the attribute of the LU.
9622	000C	84	The CTG ID is beyond the limits (more than 16) of support.	Check the CTG ID.
9622	000D	84	The pair status of the specified P-VOL is other than SSUS or PSUE.	Check the pair status of the LU.
9622	000E	84	The specified P-VOL status is normal or other than regressed.	Check the status of the LU.
9622	000F	84	The specified S-VOL is not a pair target LUN.	Check the LUN of the S-VOL.
9622	0010	84	The accepted sequence number is different from the Array ID.	Check the Array ID.
9622	0011	84	Both of the two paths are abnormal.	Check the status of the path.
9622	0012	84	When the unit of pair is specified, the pair status of the specified P-VOL is other than COPY and PAIR.	Check the pair status of the LU.
9622	0013	84	The capacity of TCE pair is beyond the limits.	Confirm the capacity of all SnapShot P-VOLs, all P-VOLs and S-VOLs of TCE pairs, and data pools less than or equal to the supported capacity for the installed cache memory.
9622	0014	84	The accepted sequence number is different from the Array ID.	Check the Array ID.
9622	0015	84	The process is in progress.	Retry after waiting for a while.
9622	0016	84	When the unit of pair is specified, the specified S-VOL is not a pair target LUN.	Check the LUN of the specified S-VOL.
9622	0017	84	The accepted sequence number is different from the Array ID.	Check the Array ID.

Table 3-5: Sense Codes (Continued)

Sense code	Detailed code	Sub code	Error contents	Recommended Action
9622	0018	84	The command with the -R option was issued to the P-VOL and that with the -S option was issued to the S-VOL.	Check the pair attribute of the LU.
9622	0019	84	This operation cannot be executed due to lack of resources.	Retry after waiting for a while.
9622	0020	84	The pool LU is not defined.	Define the pool LU and retry.
9622	0021	84	The specified fence level is STATUS.	Make sure of the specified fence level.
9622	0022	84	The capacity of TCE pair is beyond the limits.	Confirm the capacity of all SnapShot P-VOLs, all P-VOLs and S-VOLs of TCE pairs, and data pools less than or equal to the supported capacity for the installed cache memory.
9622	0023	84	The internal pair status of the specified P-VOL is "under pair deletion".	Check the pair status of the LU.
9622	0025	84	The pairsplit -P (forced blockade of a P-VOL) command was accepted.	The pairsplit -P (forced blockade of a P-VOL) command is not supported.
9622	0026	84	The type of the pairsplit command is other than Drain (ordinary splitting).	Check the command line.
9622	0027	84	The S-VOL received an instruction.	Check the pair attribute of the LU.
9622	0029	84	The S-VOL received an instruction.	Check the pair attribute of the LU.
9622	002A	84	The P-VOL received an instruction.	Check the pair attribute of the LU.
9622	002B	84	When the unit of pair is specified, the pair status of the specified S-VOL is SMPL or COPY.	Check the pair status of the LU.
9622	002C	84	The accepted sequence number is different from the Array ID.	Check the Array ID.
9622	002D	84	The specified MU number is beyond the limits (0 to13) of support.	Check the specified MU number.
9622	0030	84	The S-VOL received an instruction.	Check the pair attribute of the LU.
9622	0032	84	The RAID group, to which the specified P-VOL belongs, is RAID 0.	Check the RAID level of the specified LU.
9622	0036	84	The specified P-VOL is a SnapShot P-VOL and it is being restored.	Check the pair status of the SnapShot.
9622	0037	84	The specified P-VOL is a SnapShot P-VOL and its status was changed to PSUE during restoration.	Check the pair status of the SnapShot.

Table 3-5: Sense Codes (Continued)

Sense code	Detailed code	Sub code	Error contents	Recommended Action
9622	0038	84	There is no vacancy in the generation bits.	Retry after waiting for a while.
9622	0039	84	There is one or more pairs in the status of "under execution of pairsplit -mscas command" in the target CTG.	Check the pair status of each LU in the target CTG. It is required to wait until the process is completed.
9622	003A	84	There is one or more pairs in the status of "under pair splitting" in the target CTG.	Check the pair status of each LU in the target CTG. It is required to wait until the process is completed.
9622	003C	84	There is one or more pairs in the status of "under pair deletion" in the target CTG.	Check the pair status of each LU in the target CTG. It is required to wait until the process is completed.
9622	003D	84	The specified P-VOL is a SnapShot P-VOL and it is being restored.	Check the pair status of the SnapShot.
9622	003E	84	The specified P-VOL is a SnapShot P-VOL and its status was changed to PSUE during restoration.	Check the pair status of the SnapShot.
9622	003F	84	There is no pair, which is in the PAIR status, in the target CTG.	Check the pair status of each LU in the target CTG.
9622	0042	84	When the unit of pair is specified, the pair status of the specified pair is PSUS (no reading or writing allowed).	Check the pair status.
9622	0044	84	When the unit of CTG is specified, there is one or more pairs placed in the PSUS status (no reading or writing allowed) in the CTG.	Check the pair status of each LU in the target CTG.
9622	0045	84	When the unit of CTG is specified, there is no pair that is in the PAIR, PSUS, or PSUE status in the CTG.	Check the pair status of each LU in the target CTG.
9622	0046	84	When the unit of CTG is specified, the internal status of the pair of the specified P-VOL is "under pair splitting".	Check the pair status of the LU. It is required to wait until the process is completed.
9622	0047	84	The specified P-VOL has the incomplete DDCB.	Check the status of the LU.
9622	0048	84	The specified P-VOL has unwritten data.	Contact the service personnel.
9622	0049	84	When the unit of pair is specified, the internal status of the pair of the specified P-VOL is "under pair deletion".	Check the pair status of the LU. It is required to wait until the process is completed.
9622	004B	84	When the unit of pair is specified, the internal status of the pair of the specified P-VOL is "under execution of the pairsplit -mscas command".	Check the pair status of the LU. It is required to wait until the process is completed.

Table 3-5: Sense Codes (Continued)

Sense code	Detailed code	Sub code	Error contents	Recommended Action
9622	004C	84	When the unit of CTG is specified, there is one or more pairs that is in the status of "under pair splitting" in the CTG.	Check the pair status of each LU in the target CTG.
9622	004D	84	The DM-LU is not defined.	Define the DM-LU.
9622	004E	84	The specified P-VOL has been set to the DM-LU.	Check the attribute of the LU.
9622	004F	84	Validity of the license expired.	Purchase the license.
9622	0050	84	When the unit of CTG is specified, there is one or more pairs that is in the status of "under pair deletion" in the CTG.	Check the pair status of each LU in the target CTG.
9622	0052	84	When the unit of CTG is specified, there is one or more pairs that is in the status of "under execution of the pairsplit -mscas command" in the CTG.	Check the pair status of each LU in the target CTG.
9622	0053	84	When the unit of CTG is specified, there is no pair, which is in the COPY or PAIR status, in the target CTG.	Check the pair status of each LU in the target CTG.
9622	0054	84	The pair cancellation instruction was executed for the range that was not supported.	Check the specified value.
9622	0055	84	When the unit of pair is specified, the internal status of the pair of the specified P-VOL is "under pair splitting".	Check the pair status of the LU. It is required to wait until the process is completed.
9622	0057	84	When the unit of pair is specified, the internal status of the pair of the specified P-VOL is "under execution of the pairsplit -mscas command".	Check the pair status of the LU. It is required to wait until the process is completed.
9622	0059	84	When the unit of pair is specified, the internal status of the pair of the specified S-VOL is SSWS(R).	Check the pair status of the LU.
9622	005A	84	When the unit of CTG is specified, there is one or more pairs that is in the status of "under pair splitting" in the CTG.	Check the pair status of each LU in the target CTG.
9622	005C	84	When the unit of CTG is specified, there is one or more pairs that is in the status of "under execution of the pairsplit -mscas command" in the CTG.	Check the pair status of each LU in the target CTG.
9622	005E	84	When the unit of CTG is specified, there is one or more pairs placed in the SSWS(R) status in the CTG.	Check the pair status of each LU in the target CTG.
9622	0068	84	It is already used as an S-VOL.	Check the CTG ID.

Table 3-5: Sense Codes (Continued)

Sense code	Detailed code	Sub code	Error contents	Recommended Action
9622	0069	84	The partition to which the LU belongs is being changed to the other directory.	Retry after waiting for a while.
9622	006B	84	There is no pair, which is in the PAIR status, in the target CTG.	Check the pair status of each LU in the target CTG.
9622	006C	84	The array has not been rebooted after the TCE option was unlocked.	Reboot the array.
9622	006D	84	The specified P-VOL is a unified LU including an LU with a capacity less than 1 GB.	Check the attribute of the LU.
9622	006E	84	The specified P-VOL is the pool LU.	Check the attribute of the LU.
9622	006F	84	The pool LU status is normal or other than regressed.	Check the status of the pool LU.
9622	0070	84	The pool LU is undergoing the forced parity correction.	Check the status of the pool LU.
9622	0071	84	It is exceeded the total allowable maximum number of TCE and SnapShot pairs.	Delete unnecessary pairs.
9622	0072	84	The -mscas command was accepted with the usual process code (12 _H).	Check the CCI version.
9622	0073	84	A pair was created with an S-VOL that was placed in the SMPL status by the pair ending (pairsplit -R) command for only S-VOL and its pair status became inconsistent.	Check the pair status of the specified S-VOL.
9622	0074	84	The suspension command was accepted with a specification of the unit of pair.	The specification of the unit of pair is not supported.
9622	0075	84	The specified P-VOL is a unified LU whose component LUs include an LU for which the quick format operation is being performed.	Check the attribute of the LU.
9622	0076	84	The specified P-VOL is being quick formatted.	Check the attribute of the LU.
9622	0077	84	The state of the forced parity correction for the specified P-VOL is Uncorrected or Uncorrected 2.	Check the status of the LU.
9622	0078	84	The specified P-VOL has not undergone the forced parity correction.	Retry it after executing the forced parity correction.
9622	007B	84	There is one or more pairs in the status of PSUS or PSUE of "under pair deletion" in the target CTG.	Check the pair status of the LU. It is required to wait until the process is completed.
9622	007C	84	The number of the unused bit numbers is insufficient.	Retry after waiting for a while.
9622	007D	84	The pool LU status is normal or other than regressed.	Check the status of the pool LU.

Table 3-5: Sense Codes (Continued)

Sense code	Detailed code	Sub code	Error contents	Recommended Action
9622	007E	84	The pool LU is undergoing the forced parity correction.	Retry after waiting for a while.
9622	007F	84	There is one or more P-VOLs, the status of the forced parity correction for which is Uncorrected or Uncorrected 2, in the target CTG.	Check the status of each LU in the target CTG.
9622	0080	84	There is one or more P-VOLs, status is normal or other than regressed, in the target CTG	Check the status of each LU in the target CTG.
9622	0081	84	There is one or more TCE P-VOLs, which is cascaded with a SnapShot P-VOL being restored, in the target CTG.	Check the status of each LU in the target CTG.
9622	0082	84	There is one or more TCE P-VOLs, which is cascaded with a SnapShot P-VOL that was placed in the PSUE status during restoration, in the target CTG.	Check the status of each LU in the target CTG.
9622	0083	84	There is no pair, which is in the PSUS or PSUE status, in the target CTG.	Check the pair status of each LU in the target CTG.
9622	0084	84	When a pair is created in the new CTG, the cycle time that has been set is less than "30 x number of CTGs" seconds.	Check the cycle time that has been set.
9622	0085	84	When the unit of pair is specified, the S-VOL of the target pair has not completed the resynchronization after it accepted the resync command.	Check the TCE pair status of the remote array.
9622	0086	84	When the unit of CTG is specified, there is one or more S-VOLs, which has not completed the resynchronization after it accepted the resync command, in the target CTG.	Check the TCE pair status of the remote array.
9622	0087	84	There are one or more pairs in the status of "under pair splitting" or "under pair competing" in the CTG.	Retry after waiting for a while.
9622	0088	84	The specified P-VOL is the reserved LU.	Check the status of the LU.
9622	0089	84	The specified P-VOL is undergoing the migration.	Check the pair status of the LU.
9622	008A	84	The disk drives that configure a RAID group, to which the specified P-VOL belongs have been spun down.	Check the status of the RAID group.

Table 3-5: Sense Codes (Continued)

Sense code	Detailed code	Sub code	Error contents	Recommended Action
9622	008B	84	The disk drives that configure a RAID group, to which the specified P-VOL belongs have been spun down.	Check the status of the RAID group.
9622	008C	84	There are one or more TCE P-VOLs corresponding to a RAID group that belongs to the CTG concerned and the disk drives that configure the RAID group have been spun down.	Check the status of the RAID group.
9622	008D	84	The primary pool ID is beyond the limits of supported.	Check the pool ID.
9622	008E	84	The secondary pool ID is beyond the limits of supported.	Check the pool ID.
9622	008F	84	The specified pool ID differs from the pool ID in use.	Check the pool ID.
9622	0090	84	The Swap pair has been issued to TCE pair with AMS500 or AMS1000.	The Swap command is not supported in this configuration.
9622	0091	84	The Swap operation was received in the P-VOL.	Check the pair attribute of the LU.
9622	0092	84	The Swap operation was received by specifying the pair unit.	Confirm the operation and try again.
9622	0093	84	The LU whose pair status is not SSWS exists in the target CTG.	Check the pair status of each LU in the target CTG.
9622	0094	84	The LU whose pair status is SSWS(R) exists in the target CTG.	Check the pair status of each LU in the target CTG.
9622	0095	84	There is a pair that is a status of SSWS and also deleted just in the local array in the CTG.	Delete the pair that is a status of SSWS in the CTG, not only in the local array but also in the remote array. Then execute again.
9622	0096	84	The internal transaction, which are splitting or deleting for SnapShot is working now.	Retry after waiting for a while.
9622	0097	84	The pool LU status is normal or other than regressed.	Check the status of the pool LU.
9622	0098	84	The pool LU is undergoing the forced parity correction.	Check the status of the pool LU.
9622	0099	84	There is one or more S-VOLs, the status of the forced parity correction for which is Uncorrected or Uncorrected 2, in the target CTG.	Check the status of each LU in the target CTG.
9622	009A	84	There is one or more S-VOLs, status is normal or other than regressed, in the target CTG.	Check the status of each LU in the target CTG.

Table 3-5: Sense Codes (Continued)

Sense code	Detailed code	Sub code	Error contents	Recommended Action
9622	009B	84	There is one or more TCE S-VOLs, which is cascaded with a SnapShot P-VOL being restored, in the target CTG.	Check the status of each LU in the target CTG.
9622	009C	84	There is one or more TCE S-VOLs, which is cascaded with a SnapShot P-VOL that was placed in the PSUE status during restoration, in the target CTG.	Check the status of each LU in the target CTG.
9622	009D	84	There is one or more S-VOLs of TCE pair in the same CTG, the RAID group that belong to is in Power Saving mode.	Check the status of each LU in the target CTG.
9622	009E	84	The firmware internal error occurred.	Retry after waiting for a while. If an error occurred again, contact the service personnel.
9622	009F	84	The specified secondary sequence number does not match with the remote array serial number.	Check the specified command device number.
9622	00A0	84	The command cannot execute because the Auto Migration is undergoing.	Check the Migration status.
9622	00A1	84	The command cannot execute because the Auto Migration is undergoing.	Check the Migration status.
9622	00A2	84	The command cannot execute because the Auto Migration is undergoing.	Check the Migration status.
9622	00A3	84	The RAID group to which the specified LU belongs indicates a status other than Normal.	Retry after the status becomes Normal.
9622	00A4	84	An LU that belongs to the RAID group that indicates a status other than Normal is included in the data pool that is specified in the pair operation, or is used by specified pair.	Retry after the RAID group status becomes Normal.
9622	00A5	84	An LU that belongs to the RAID group that indicates a status other than Normal is included in the group to which the specified pair belongs.	Retry after the RAID group status becomes Normal.
9622	00A6	84	An LU, belonging to the RAID group that indicates a status other than Normal, is included in the data pool that is used by pairs belonging to the same group as the specified pair.	Retry after the RAID group status becomes Normal.
9622	00A7	84	The LU created in DP pool was specified as P-VOL.	Specify an LU other than the LU created in DP pool.

Table 3-5: Sense Codes (Continued)

Sense code	Detailed code	Sub code	Error contents	Recommended Action
9622	00A8	84	The LU that was specified as P-VOL does not exist.	Check the specified LUN.
9622	00AA	84	The operation cannot be performed due to insufficient capacity of the DP pool for the specified P-VOL.	Check the capacity of the DP pool.
9622	00AD	84	The memory reconfiguration process is in progress.	Retry after the memory reconfiguration process completes.
9622	00AF	84	The full capacity mode differs between the target LU and data pools.	Set both target LU and data pools the same value.
9629	0001	84	The Volume Migration optional feature is invalid.	Install the Volume Migration optional feature.
9629	0002	84	The temporary key of the Volume Migration was expired.	Purchase the license.
9629	0003	84	The status of the specified P-VOL is other than normal or regressive.	Check the status of the LU.
9629	0004	84	The status of the specified S-VOL is other than normal or regressive.	Check the status of the LU.
9629	0005	84	The status of the parity correction of the specified P-VOL is Uncorrected or Uncorrected 2.	Skip the parity correction or execute the parity correction, and wait for the completion of the correction. Re-execute it after performing the operation.
9629	0006	84	The status of the parity correction of the specified S-VOL is correcting, waiting correction, Uncorrected, or Uncorrected 2.	Skip the parity correction or execute the parity correction, and wait for the completion of the correction. Re-execute it after performing the operation.
9629	0007	84	The specified P-VOL has created a Volume Migration pair.	Check the pair status of the LU.
9629	0008	84	The specified S-VOL has created a Volume Migration pair.	Check the pair status of the LU.
9629	0009	84	The specified P-VOL has created a ShadowImage pair.	Check the pair status of the LU.
9629	000A	84	The specified S-VOL has created a ShadowImage pair.	Check the pair status of the LU.
9629	000B	84	The specified P-VOL is a command device.	Check the status of the LU.
9629	000C	84	The specified S-VOL is a command device.	Check the status of the LU.
9629	000D	84	The specified P-VOL has created a TrueCopy pair.	Check the pair status of the LU.
9629	000E	84	The specified S-VOL has created a TrueCopy pair.	Check the pair status of the LU.

Table 3-5: Sense Codes (Continued)

Sense code	Detailed code	Sub code	Error contents	Recommended Action
9629	0010	84	The specified S-VOL has created a TCE pair.	Check the pair status of the LU.
9629	0011	84	The P-VOL is a Cache Residency LU or has been set to the reserved Cache Residency LU.	Check the status of the LU.
9629	0012	84	The S-VOL is a Cache Residency LU or has been set to the reserved Cache Residency LU.	Check the status of the LU.
9629	0013	84	The specified P-VOL has created a SnapShot pair.	Check the pair status of the LU.
9629	0014	84	The specified S-VOL has created a SnapShot pair.	Check the pair status of the LU.
9629	0015	84	The specified P-VOL is the pool LU.	Check the status of the LU.
9629	0016	84	The specified S-VOL is the pool LU.	Check the status of the LU.
9629	0017	84	The specified P-VOL is being quick formatted.	Retry after the quick formatting is completed.
9629	0018	84	The specified S-VOL is being quick formatted.	Retry after the quick formatting is completed.
9629	0019	84	The specified P-VOL is the DM-LU.	Check the status of the LU.
9629	001A	84	The specified S-VOL is the DM-LU.	Check the status of the LU.
9629	001B	84	The DM-LU is not set.	Retry after setting the DM-LU.
9629	001C	84	The specified P-VOL has unwritten data.	Check the status of the LU.
9629	001D	84	The pair cannot be allocated the differential bit map.	Split the unnecessary pairs.
9629	001E	84	The specified P-VOL is a SubLU of a unified LU.	Check the status of the LU.
9629	001F	84	The specified S-VOL is a SubLU of a unified LU.	Check the status of the LU.
9629	0020	84	The size of the specified P-VOL and the S-VOL are not the same.	Specify an LU that the same size.
9629	0021	84	The DIRs in charge of the specified P-VOL and the S-VOL are not the same.	Specify an LU that belongs to the same DIR.
9629	0022	84	The LUNs of the specified P-VOL and S-VOL are the same.	Check the specified LUN.
9629	0023	84	There exist maximum number of pairs already (included ShadowImage pairs).	Split the unnecessary pairs.
9629	0024	84	The specified P-VOL is the LU, for which a change of the cache partitions had been reserved.	Retry after releasing the reserved status.
9629	0025	84	The specified S-VOL is the LU, for which a change of the cache partitions had been reserved.	Retry after releasing the reserved status.

Table 3-5: Sense Codes (Continued)

Sense code	Detailed code	Sub code	Error contents	Recommended Action
9629	0026	84	The RAID group of the specified P-VOL and S-VOL are the same.	Specify a different RAID group.
9629	0027	84	The specified P-VOL is the reserved LU.	Check the status of the LU.
9629	0028	84	The specified S-VOL is the reserved LU.	Check the status of the LU.
9629	0029	84	The access level of the specified S-VOL is other than the ordinary one.	Check the access level of the LU.
9629	002C	84	The specified MU number is 8 or higher.	Make sure of the specified MU number.
9629	002D	84	The specified primary port number is beyond the limits of support.	Check the specified primary port number.
9629	002E	84	The specified secondary port number is beyond the limits of support.	Check the specified secondary port number.
9629	002F	84	The specified primary sequence number is different from the own serial number.	Check the specified primary sequence number.
9629	0030	84	The specified secondary sequence number is different from the own serial number.	Check the specified secondary sequence number.
9629	0031	84	The pair concerned is the one that the instruction to start the migration was issued by Navigator 2 or HiCommand.	Check the owner ID of the specified pair.
9629	0032	84	The disk drives that configure a RAID group, to which the specified P-VOL belongs have been spun down.	Check the status of the RAID group.
9629	0033	84	The disk drives that configure a RAID group, to which the specified S-VOL belongs have been spun down.	Check the status of the RAID group.
9629	0034	84	The data migration status is "data is being copied", "data copy fails", or "data copy is completed".	Check the data migration status.
9629	0035	84	The data migration status is "access path is being switched" or "access path switching fails".	Check the data migration status.
9629	0036	84	The RAID group to which the specified LU belongs indicates a status other than Normal.	Retry after the status becomes Normal.
9629	0037	84	The LU created in DP pool was specified as P-VOL or S-VOL.	Specify an LU other than the LU created in DP pool.
9629	0038	84	The specified P-VOL and S-VOL are LUs in the same DP pool.	Check the specified LUs.

Table 3-5: Sense Codes (Continued)

Sense code	Detailed code	Sub code	Error contents	Recommended Action
9629	0039	84	The specified S-VOL is an LU created in a DP pool and the capacity of the DP pool is not enough.	Check the DP pool capacity.
9629	003A	84	The DP optimization status of the specified P-VOL is not Normal.	Check the DP optimization status of the P-VOL.
9629	003B	84	The DP optimization status of the specified S-VOL is not Normal.	Check the DP optimization status of the S-VOL.
9629	003C	84	Management information regarding DP is being updated.	Wait a while, then retry.
9629	003D	84	Management information regarding DP is being updated.	Wait a while, then retry.
9629	003E	84	The specified P-VOL cannot be read due to insufficient capacity of its DP pool.	Check the DP pool capacity.
9629	0040	84	The full capacity mode differs between the P-VOL and S-VOL.	Set both P-VOL and S-VOL the same value.

Logging of a command

Normally, logging of a command collects the error information when an error occurs in the command execution. In addition, it provides a function of logging all commands for the purpose of the examination and the verification of the command issued by you script. The logging of all the commands can be done through the setting of the following control valuables.

- HORCC_LOGSZ=file size: valuable

This valuable specifies the maximum size of the command log file. The \$HORCC_LOG/horcc_HOST.log file is moved to the \$HORCC_LOG/horcc_HOST.oldlog file when its size (in kB) exceeds the specified size.

This variable can be defined as an environmental variable or the following \$HORCC_LOG/horcc_HOST.conf file. When this variable is not specified or the size is specified as zero, the logging is done as a default operation only when an error occurs.

Setting example:

```
HORCC_LOGSZ=2048
Export HORCC_LOGSZ
```

- \$HORCC_LOG/horcc_HOST.conf file

This file describes the HORCC_LOGSZ variable and the variable for masking the logging. Specify the maximum size. When the variable is not specified as the environmental variable, the HORCC_LOGSZ variable described in this file is used. When neither of them is specified, the logging is done as a default operation only when an error occurs.

- HORCC_LOGSZ variable

Describes as following.

```
# For example  
HORCC_LOGSZ=2048
```

- Masking variable

This masking variable specifies a command name and a return value. However, the inraid command and error codes are excluded. For example, when you script tests the return value of the pairvolchk command at regular intervals, the log data may overflow. In this case, the logging can be masked through the specification of the HORCC_LOGSZ environmental variable as zero, but the script must be changed as shown below.

```
# For example masking pairvolchk on the script  
export HORCC_LOGSZ=0  
Pairvolchk -g xxx -s  
Unset HORCC_LOGSZ
```

This function validates logging of a command without changing you script.

```
# For example,
# if you want to mask pairvolchk (returns 22) and raidqry,
# you can specify as below.

pairvolchk=22
raidqry=0
```

The user decides whether or not to mask you script after tracking the \$HORCC_LOG/horcc_HOST.conf file without masking you script.

- Relation between the environmental variable and the \$HORCC_LOG/horcc_HOST.conf file

When the HORCC_LOGSZ environmental variable is not specified, the HORCC_LOGSZ variable described in the \$HORCC_LOG/horcc_HOST.conf file is used. When neither of them is specified, the logging is done as a default operation only when an error occurs.

Table 3-6: Relation Between the Environmental Variable and the \$HORCC_LOG/horcc_HOST.conf file

\$HORCC_LOGSZ	HORCC_HOST.conf	Operation
\$HORCC_LOGSZ=size	It is not influenced specification.	The logging is valid in the specified script.
\$HORCC_LOGSZ=0		The logging is invalid in the specified script.
It is not specified	HORCC_LOGSZ=size	The logging is valid in the instance.
	HORCC_LOGSZ=0	The logging is invalid in the instance.
	It is not specified or no file exists.	Default logging (logging is done only when an error occurs)

Example: \HORCM\log* directory

```
[root@raidmanager log9]# ls -l
total 16
drwxr-xr-x  3 root root    4096 Oct 27 17:33 curlog
-rw-r--r--  1 root root    3936 Oct 27 17:36 horcc_raidmanager.log
-rw-r--r--  1 root root 2097452 Oct 27 17:29 horcc_raidmanager.oldlog
-rw-r--r--  1 root root     46 Oct 27 17:19 horcc_raidmanager.conf
drwxr-xr-x  3 root root    4096 Oct 27 17:19 tmplog
```

- \HORCM\log*\horcc_HOST.log file

```
COMMAND NORMAL : EUserId for HORC : root (0) Tue Nov 1 12:21:53 2005
CMDLINE : pairvolchk -ss -g URA
12:21:54-2d27f-10090- [pairvolchk][exit(32)]
COMMAND NORMAL : EUserId for HORC : root (0) Thu Oct 27 17:36:32 2005
CMDLINE : raidqry -l
17:36:32-3d83c-17539- [raidqry][exit(0)]
COMMAND ERROR : EUserId for HORC : root (0) Thu Oct 27 17:31:28 2005
CMDLINE : pairedisplay -g UR
17:31:28-9a206-17514- ERROR:cm_sndrcv[rc < 0 from HORCM]
17:31:28-9b0a3-17514- [pairedisplay][exit(239)]
[EX_ENOGRP] No such group
[Cause ]:The group name which was designated or the device name doesn't exist
in the configuration file,or the network address for remote communication
doesn't exist.
[Action]:Please confirm if the group name exists in the configuration file
of the local and remote host.
```

- \HORCM\log*\horcc_HOST.conf file

```
# For Example
HORCC_LOGSZ=2048

# The masking variable
# This variable is used to disable the logging by the command and exit code.
# For masking below log pairvolchk returned `32'(status is "SVOL_COPY")
# COMMAND NORMAL : EUserId for HORC : root (0) Tue Nov 1 12:21:53 2005
# CMDLINE : pairvolchk -ss -g URA
# 12:21:54-2d27f-10090- [pairvolchk][exit(32)]

pairvolchk=32
pairvolchk=22
```

Command options

This chapter shows the command options that are available for SnapShot, ShadowImage, TrueCopy, and TCE.

- [Command options for copy types](#)

Command options for copy types

Table 4-1 shows the command options for the copy types.

Table 4-1: Command Options for Copy Types

Command	Options	Shadow-Image	Snap-Shot	True-Copy	TCE
paircreate	-h	Yes	Yes	Yes	Yes
	-z	Yes	Yes	Yes	Yes
	-zx	Yes	Yes	Yes	Yes
	-l[instance#]	Yes	Yes	Yes	Yes
	-IH[instance#] -ITC[instance#]	No	No	Yes	Yes
	-IM[instance#] -ISI[instance#]	Yes	Yes	No	No
	-q	Yes	Yes	Yes	Yes
	-xh	Yes	Yes	Yes	Yes
	-x <command> <arg>	No		No	No
	-g [s] <group>	Yes	Yes	Yes	Yes
	-d [s] <pair Vol>	Yes	Yes	Yes	Yes
	-d [g] [s] <drive#(0-N)> [MU#]	Yes	Yes	Yes	Yes
	-d [g] [s] <seq#> <LDEV#> [MU#]	Yes	Yes	Yes	Yes
	-nomsg	Yes	Yes	Yes	Yes
	-vl or -pvol	Yes	Yes	Yes	Yes
	-vr os -svol	Yes	Yes	Yes	Yes
	-f <fence> [CTGID]	No	No	Yes	Yes
	-fg <fence> [CTGID]	No	No	Yes	No
	-jp <PID> -js <PID>	No	No	No	Yes
	-c <size>	Yes	Yes	Yes	Yes
	-cto <o-time> [c-time] [r-time]	No	No	No	No
	-nocopy	No	No	Yes	Yes
	-m <mode>	Yes	Yes	Yes	Yes
	-split [Split-Marker]	Yes	Yes	No	No
	-fq <mode>	No	No	No	No
	-pid <PID>	No	Yes	No	No
	-nocsus	No	No	No	No

Table 4-1: Command Options for Copy Types (Continued)

Command	Options	Shadow-Image	Snap-Shot	True-Copy	TCE
pairsplit	-h	Yes	Yes	Yes	Yes
	-z	Yes	Yes	Yes	Yes
	-zx	Yes	Yes	Yes	Yes
	-I[instance#]	Yes	Yes	Yes	Yes
	-IH[instance#] -ITC[instance#]	No	No	Yes	Yes
	-IM[instance#] -ISI[instance#]	Yes	Yes	No	No
	-q	Yes	Yes	Yes	Yes
	-xh	Yes	Yes	Yes	Yes
	-x <command> <arg>	No	No	No	No
	-g <group>	Yes	Yes	Yes	Yes
	-d <pair Vol>	Yes	Yes	Yes	Yes
	-d [g] <drive#(0-N)> [MU#]	Yes	Yes	Yes	Yes
	-d [g] <seq#> <LDEV#> [MU#]	Yes	Yes	Yes	Yes
	-nomsg	Yes	Yes	Yes	Yes
	-r	No	No	Yes	Yes
	-rw	No	No	Yes	Yes
	-S	Yes	Yes	Yes	Yes
	-R	No	No	Yes	Yes
	-RS	No	No	No	No
	-RB	No	No	Yes	No
	-P	No	No	Yes	No
	-l	Yes	Yes	Yes	Yes
	-FHORC [MU#]	Yes	Yes	No	No
	-FMRCF [MU#]	No	No	Yes	Yes
	-ms <Split-Marker> [MU#]	Yes	Yes	No	No
	-mscal <Split-Marker> [MU#]	No	No	No	Yes
	-C <size>	Yes	Yes	No	No
	-E	Yes	No	No	No
	-fq <mode>	No	No	No	No

Table 4-1: Command Options for Copy Types (Continued)

Command	Options	Shadow-Image	Snap-Shot	True-Copy	TCE
pairresync	-h	Yes	Yes	Yes	Yes
	-z	Yes	Yes	Yes	Yes
	-zx	Yes	Yes	Yes	Yes
	-I[instance#]	Yes	Yes	Yes	Yes
	-IH[instance#] -ITC[instance#]	No	No	Yes	Yes
	-IM[instance#] -ISI[instance#]	Yes	Yes	No	No
	-q	Yes	Yes	Yes	Yes
	-xh	Yes	Yes	Yes	Yes
	-x <command> <arg>	No	No	No	No
	-g <group>	Yes	Yes	Yes	Yes
	-d <pair Vol>	Yes	Yes	Yes	Yes
	-d [g] <drive#(0-N)> [MU#]	Yes	Yes	Yes	Yes
	-d [g] <seq#> <LDEV#> [MU#]	Yes	Yes	Yes	Yes
	-nomsg	Yes	Yes	Yes	Yes
	-c <size>	Yes	Yes	Yes	Yes
	-cto <o-time> [c-time] [r-time]	No	No	No	No
	-l	Yes	Yes	Yes	Yes
	-FHORC [MU#]	Yes	Yes	No	No
	-FMRCF [MU#]	No	No	Yes	Yes
	-swapp	No	No	Yes	Yes
	-swaps	No	No	Yes	Yes
	-restore	Yes	Yes	No	No
	-fq <mode>	No	No	No	No
	-f [g] <fence> [CTGID]	No	No	No	No

Table 4-1: Command Options for Copy Types (Continued)

Command	Options	Shadow-Image	Snap-Shot	True-Copy	TCE
pairevtwait	-h	Yes	Yes	Yes	Yes
	-z	Yes	Yes	Yes	Yes
	-zx	Yes	Yes	Yes	Yes
	-I[instance#]	Yes	Yes	Yes	Yes
	-IH[instance#] -ITC[instance#]	No	No	Yes	Yes
	-IM[instance#] -ISI[instance#]	Yes	Yes	No	No
	-q	Yes	Yes	Yes	Yes
	-xh	Yes	Yes	Yes	Yes
	-x <command> <arg>	No	No	No	No
	-g <group>	Yes	Yes	Yes	Yes
	-d <pair Vol>	Yes	Yes	Yes	Yes
	-d [g] <drive#(0-N)> [MU#]	Yes	Yes	Yes	Yes
	-d [g] <seq#> <LDEV#> [MU#]	Yes	Yes	Yes	Yes
	-nomsg	Yes	Yes	Yes	Yes
	-nowait	Yes	Yes	Yes	Yes
	-nowaits	Yes	Yes	Yes	Yes
	-s <status>	Yes	Yes	Yes	Yes
	-ss <status>	Yes	Yes	Yes	Yes
	-t <timeout> [interval]	Yes	Yes	Yes	Yes
	-l	Yes	Yes	Yes	Yes
-FHORC [MU#]	Yes	Yes	No	No	
-FMRCF [MU#]	No	No	Yes	Yes	
pairsyncwait	-h	No	No	No	Yes
	-z	No	No	No	Yes
	-zx	No	No	No	Yes
	-I[instance#]	No	No	No	Yes
	-IH[instance#] -ITC[instance#]	No	No	No	Yes
	-IM[instance#] -ISI[instance#]	No	No	No	No
	-q	No	No	No	Yes
	-xh	No	No	No	Yes
	-x <command> <arg>	No	No	No	No
	-g <group>	No	No	No	Yes
	-d <pair Vol>	No	No	No	Yes
	-d [g] <drive#(0-N)> [MU#]	No	No	No	Yes
	-d [g] <seq#> <LDEV#> [MU#]	No	No	No	Yes
	-nomsg	No	No	No	Yes
	-nowait	No	No	No	Yes
	-t <timeout> [interval]	No	No	No	Yes
	-m <Q-Marker>	No	No	No	Yes
	-fq	No	No	No	No

Table 4-1: Command Options for Copy Types (Continued)

Command	Options	Shadow-Image	Snap-Shot	True-Copy	TCE
pairmon	-h	Yes	Yes	Yes	Yes
	-z	Yes	Yes	Yes	Yes
	-zx	Yes	Yes	Yes	Yes
	-I[instance#]	Yes	Yes	Yes	Yes
	-IH[instance#] -ITC[instance#]	No	No	Yes	Yes
	-IM[instance#] -ISI[instance#]	Yes	Yes	No	No
	-q	Yes	Yes	Yes	Yes
	-xh	Yes	Yes	Yes	Yes
	-x <command> <arg>	No	No	No	No
	-D	Yes	Yes	Yes	Yes
	-allsnd	Yes	Yes	Yes	Yes
	-resevt	Yes	Yes	Yes	Yes
	-nowait	Yes	Yes	Yes	Yes
	-s <status>	Yes	Yes	Yes	Yes
pairvolchk	-h	Yes	Yes	Yes	Yes
	-z	Yes	Yes	Yes	Yes
	-zx	Yes	Yes	Yes	Yes
	-I[instance#]	Yes	Yes	Yes	Yes
	-IH[instance#] -ITC[instance#]	No	No	Yes	Yes
	-IM[instance#] -ISI[instance#]	Yes	Yes	No	No
	-q	Yes	Yes	Yes	Yes
	-xh	Yes	Yes	Yes	Yes
	-x <command> <arg>	No	No	No	No
	-g <group>	Yes	Yes	Yes	Yes
	-d <pair Vol>	Yes	Yes	Yes	Yes
	-d [g] <drive#(0-N)> [MU#]	Yes	Yes	Yes	Yes
	-d [g] <seq#> <LDEV#> [MU#]	Yes	Yes	Yes	Yes
	-nomsg	Yes	Yes	Yes	Yes
	-c	Yes	Yes	Yes	Yes
	-ss	Yes	Yes	Yes	Yes
	-FHORC [MU#]	Yes	Yes	No	No
	-FMRCF [MU#]	No	No	Yes	Yes

Table 4-1: Command Options for Copy Types (Continued)

Command	Options	Shadow-Image	Snap-Shot	True-Copy	TCE
pairdisplay	-h	Yes	Yes	Yes	Yes
	-z	Yes	Yes	Yes	Yes
	-zx	Yes	Yes	Yes	Yes
	-I[instance#]	Yes	Yes	Yes	Yes
	-IH[instance#] -ITC[instance#]	No	No	Yes	Yes
	-IM[instance#] -ISI[instance#]	Yes	Yes	No	No
	-q	Yes	Yes	Yes	Yes
	-xh	Yes	Yes	Yes	Yes
	-x <command> <arg>	No	No	No	No
	-g <group>	Yes	Yes	Yes	Yes
	-d <pair Vol>	Yes	Yes	Yes	Yes
	-d [g] <drive#(0-N)> [MU#]	Yes	Yes	Yes	Yes
	-d [g] <seq#> <LDEV#> [MU#]	Yes	Yes	Yes	Yes
	-c	Yes	Yes	Yes	Yes
	-l	Yes	Yes	Yes	Yes
	-m <mode>	Yes	Yes	Yes	Yes
	-f [x]	Yes	Yes	Yes	Yes
	-f [c]	Yes	Yes	Yes	Yes
	-f [d]	Yes	Yes	Yes	Yes
	-f [m]	No	No	No	No
	-f [e]	Yes	Yes	Yes	Yes
	-f [w]	Yes	Yes	Yes	Yes
	-f [r]	No	No	No	No
	-CLI	Yes	Yes	Yes	Yes
	-FHORC [MU#]	Yes	Yes	No	No
	-FMRCF [MU#]	No	No	Yes	Yes
	-v jnl [t]	No	No	No	No
	-v ctg	No	No	No	No
	-v smk	Yes	Yes	No	No
	-v pid	No	Yes	No	No

Table 4-1: Command Options for Copy Types (Continued)

Command	Options	Shadow-Image	Snap-Shot	True-Copy	TCE
paircurchk	-h	No	No	Yes	Yes
	-z	No	No	Yes	Yes
	-zx	No	No	Yes	Yes
	-I[instance#]	No	No	Yes	Yes
	-IH[instance#] -ITC[instance#]	No	No	Yes	Yes
	-IM[instance#] -ISI[instance#]	No	No	No	No
	-q	No	No	Yes	Yes
	-xh	No	No	Yes	Yes
	-x <command> <arg>	No	No	No	No
	-g <group>	No	No	Yes	Yes
	-d <pair Vol>	No	No	Yes	Yes
	-d [g] <drive#(0-N)> [MU#]	No	No	Yes	Yes
	-d [g] <seq#> <LDEV#> [MU#]	No	No	Yes	Yes
	-nomsg	No	No	Yes	Yes
horctakeover	-h	No	No	Yes	Yes
	-z	No	No	Yes	Yes
	-zx	No	No	Yes	Yes
	-I[instance#]	No	No	Yes	Yes
	-IH[instance#] -ITC[instance#]	No	No	Yes	Yes
	-IM[instance#] -ISI[instance#]	No	No	No	No
	-q	No	No	Yes	Yes
	-xh	No	No	Yes	Yes
	-x <command> <arg>	No	No	No	No
	-g <group>	No	No	Yes	Yes
	-d <pair Vol>	No	No	Yes	Yes
	-d [g] <drive#(0-N)> [MU#]	No	No	Yes	Yes
	-d [g] <seq#> <LDEV#> [MU#]	No	No	Yes	Yes
	-nomsg	No	No	Yes	Yes
	-S	No	No	Yes	Yes
	-l	No	No	Yes	No
	-t <timeout>	No	No	Yes	Yes

Table 4-1: Command Options for Copy Types (Continued)

Command	Options	Shadow-Image	Snap-Shot	True-Copy	TCE
horctakeoff	-h	No	No	No	No
	-z	No	No	No	No
	-zx	No	No	No	No
	-I[instance#]	No	No	No	No
	-IH[instance#] -ITC[instance#]	No	No	No	No
	-IM[instance#] -ISI[instance#]	No	No	No	No
	-q	No	No	No	No
	-xh	No	No	No	No
	-x <command> <arg>	No	No	No	No
	-g[s] <group>	No	No	No	No
	-d[s] <pair Vol>	No	No	No	No
	-d [g][s] <drive#(0-N)> [MU#]	No	No	No	No
	-d [g][s] <seq#> <LDEV#> [MU#]	No	No	No	No
	-nomsg	No	No	No	No
	-t <timeout>	No	No	No	No
-jp <PID> -js <PID>	No	No	No	No	

Table 4-1: Command Options for Copy Types (Continued)

Command	Options	Shadow-Image	Snap-Shot	True-Copy	TCE
raidscan	-h	Yes	Yes	Yes	Yes
	-z	Yes	Yes	Yes	Yes
	-zx	Yes	Yes	Yes	Yes
	-I[instance#]	Yes	Yes	Yes	Yes
	-IH[instance#] -ITC[instance#]	No	No	Yes	Yes
	-IM[instance#] -ISI[instance#]	Yes	Yes	No	No
	-q	Yes	Yes	Yes	Yes
	-xh	Yes	Yes	Yes	Yes
	-x <command> <arg>	No	No	No	No
	-p <port> [hgrp]	Yes	Yes	Yes	Yes
	-pd [g] <drive#(0-N)>	Yes	Yes	Yes	Yes
	-pi <strings>	Yes	Yes	Yes	Yes
	-t <targ>	Yes	Yes	Yes	Yes
	-l <lun>	Yes	Yes	Yes	Yes
	-m <mun>	Yes	Yes	Yes	Yes
	-s <seq#>	Yes	Yes	Yes	Yes
	-f [f]	Yes	Yes	Yes	Yes
	-f [x]	Yes	Yes	Yes	Yes
	-f [g]	Yes	Yes	Yes	Yes
	-f [d]	Yes	Yes	Yes	Yes
	-f [e]	Yes	Yes	Yes	Yes
	-f [r]	No	No	No	No
	-CLI	Yes	Yes	Yes	Yes
	-find [g]	Yes	Yes	Yes	Yes
	-find inst	Yes	Yes	Yes	Yes
	-find verify	Yes	Yes	Yes	Yes
	-find [g] conf	Yes	Yes	Yes	Yes
-find sync	Yes	Yes	Yes	Yes	
-find syncd	No	No	No	No	

Table 4-1: Command Options for Copy Types (Continued)

Command	Options	Shadow-Image	Snap-Shot	True-Copy	TCE
raidar	-h	Yes	Yes	Yes	Yes
	-z	Yes	Yes	Yes	Yes
	-zx	Yes	Yes	Yes	Yes
	-I[instance#]	Yes	Yes	Yes	Yes
	-IH[instance#] -ITC[instance#]	No	No	Yes	Yes
	-IM[instance#] -ISI[instance#]	Yes	Yes	No	No
	-q	Yes	Yes	Yes	Yes
	-xh	Yes	Yes	Yes	Yes
	-x <command> <arg>	No	No	No	No
	-s <interval> [count]	Yes	Yes	Yes	Yes
	-sm <interval> [count]	Yes	Yes	Yes	Yes
	-p <port> <targ> <lun>	Yes	Yes	Yes	Yes
	-pd [g] <drive#(0-N)>	Yes	Yes	Yes	Yes
raidqry	-h	Yes	Yes	Yes	Yes
	-z	Yes	Yes	Yes	Yes
	-zx	Yes	Yes	Yes	Yes
	-I[instance#]	Yes	Yes	Yes	Yes
	-IH[instance#] -ITC[instance#]	No	No	Yes	Yes
	-IM[instance#] -ISI[instance#]	Yes	Yes	No	No
	-q	Yes	Yes	Yes	Yes
	-xh	Yes	Yes	Yes	Yes
	-x <command> <arg>	No	No	No	No
	-g	Yes	Yes	Yes	Yes
	-l	Yes	Yes	Yes	Yes
	-r <group>	Yes	Yes	Yes	Yes
	-f	Yes	Yes	Yes	Yes

Table 4-1: Command Options for Copy Types (Continued)

Command	Options	Shadow-Image	Snap-Shot	True-Copy	TCE
horcctl	-h	Yes	Yes	Yes	Yes
	-z	Yes	Yes	Yes	Yes
	-zx	Yes	Yes	Yes	Yes
	-I[instance#]	Yes	Yes	Yes	Yes
	-IH[instance#] -ITC[instance#]	No	No	Yes	Yes
	-IM[instance#] -ISI[instance#]	Yes	Yes	No	No
	-q	Yes	Yes	Yes	Yes
	--num	No	No	No	No
	-xh	Yes	Yes	Yes	Yes
	-x <command> <arg>	No	No	No	No
	-d	Yes	Yes	Yes	Yes
	-c	Yes	Yes	Yes	Yes
	-S	Yes	Yes	Yes	Yes
	-D	Yes	Yes	Yes	Yes
	-DI	No	No	No	No
	-C	Yes	Yes	Yes	Yes
	-u <unitid>	Yes	Yes	Yes	Yes
	-ND	Yes	Yes	Yes	Yes
	-NC	Yes	Yes	Yes	Yes
	-g <group>	No	No	No	No
	-l <level>	Yes	Yes	Yes	Yes
	-b <y/n>	Yes	Yes	Yes	Yes
	-s <size(KB)>	Yes	Yes	Yes	Yes
-t <type>	Yes	Yes	Yes	Yes	

Table 4-1: Command Options for Copy Types (Continued)

Command	Options	Shadow-Image	Snap-Shot	True-Copy	TCE
raidvchkset	-h	Yes	Yes	Yes	Yes
	-z	Yes	Yes	Yes	Yes
	-zx	Yes	Yes	Yes	Yes
	-I[instance#]	Yes	Yes	Yes	Yes
	-IH[instance#] -ITC[instance#]	No	No	Yes	Yes
	-IM[instance#] -ISI[instance#]	Yes	Yes	No	No
	-q	Yes	Yes	Yes	Yes
	-xh	Yes	Yes	Yes	Yes
	-x <command> <arg>	No	No	No	No
	-g <group>	Yes	Yes	Yes	Yes
	-d <pair Vol>	Yes	Yes	Yes	Yes
	-d [g] <drive#(0-N)> [MU#]	Yes	Yes	Yes	Yes
	-d [g] <seq#> <LDEV#> [MU#]	Yes	Yes	Yes	Yes
	-nomsg	Yes	Yes	Yes	Yes
	-vt [type]	No	No	No	No
	-vs <bsize> [SLBA] [ELBA]	No	No	No	No
	-vg [type] [rtime]	Yes	Yes	Yes	Yes
	-vext <size>	No	No	No	No
raidvchkdsp	-h	Yes	Yes	Yes	Yes
	-z	Yes	Yes	Yes	Yes
	-zx	Yes	Yes	Yes	Yes
	-I[instance#]	Yes	Yes	Yes	Yes
	-IH[instance#] -ITC[instance#]	No	No	Yes	Yes
	-IM[instance#] -ISI[instance#]	Yes	Yes	No	No
	-q	Yes	Yes	Yes	Yes
	-xh	Yes	Yes	Yes	Yes
	-x <command> <arg>	No	No	No	No
	-g <group>	Yes	Yes	Yes	Yes
	-d <pair Vol>	Yes	Yes	Yes	Yes
	-d [g] <drive#(0-N)> [MU#]	Yes	Yes	Yes	Yes
	-d [g] <seq#> <LDEV#> [MU#]	Yes	Yes	Yes	Yes
	-f [x]	Yes	Yes	Yes	Yes
	-f [d]	Yes	Yes	Yes	Yes
	-f [e]	No	No	No	No
	-v gflag	Yes	Yes	Yes	Yes
	-v pool	No	Yes	No	No
	-v cflag	No	No	No	No
	-v offset	No	No	No	No
	-v errcnt	No	No	No	No
	-v aoub	No	No	No	NoNo
	-c	Yes	Yes	Yes	Yes

Table 4-1: Command Options for Copy Types (Continued)

Command	Options	Shadow-Image	Snap-Shot	True-Copy	TCE
raidvchkscan	-h	Yes	Yes	Yes	Yes
	-z	Yes	Yes	Yes	Yes
	-zx	Yes	Yes	Yes	Yes
	-I[instance#]	Yes	Yes	Yes	Yes
	-IH[instance#] -ITC[instance#]	No	No	Yes	Yes
	-IM[instance#] -ISI[instance#]	Yes	Yes	No	No
	-q	Yes	Yes	Yes	Yes
	-xh	Yes	Yes	Yes	Yes
	-x <command> <arg>	No	No	No	No
	-p <port> [hgrp]	Yes	Yes	Yes	Yes
	-pd [g] <drive#(0-N)>	Yes	Yes	Yes	Yes
	-t <targ>	Yes	Yes	Yes	Yes
	-l [lun]	Yes	Yes	Yes	Yes
	-s [seq#]	Yes	Yes	Yes	Yes
	-f [x]	Yes	Yes	Yes	Yes
	-v gflag	Yes	Yes	Yes	Yes
	-v pid <PID>	No	Yes	No	No
	-v jnl [t]	No	No	No	No
	-v pida	No	No	No	No
	-v pids	No	No	No	No
	-v pool	No	No	No	No
	-v eflag	No	No	No	No
	-v offset	No	No	No	No
	-v aou	No	No	No	No
-v aoub	No	No	No	No	

Table 4-1: Command Options for Copy Types (Continued)

Command	Options	Shadow-Image	Snap-Shot	True-Copy	TCE
inqraid	-h	Yes	Yes	Yes	Yes
	-quit	Yes	Yes	Yes	Yes
	-inqdump	Yes	Yes	Yes	Yes
	-fx	Yes	Yes	Yes	Yes
	-find [c]	Yes	Yes	Yes	Yes
	-CLI	Yes	Yes	No	No
	-CLIWP, -CLIWN	Yes	Yes	Yes	Yes
	-sort [CM]	Yes	Yes	Yes	Yes
	--gvinf, -gvinfex	Yes	Yes	Yes	Yes
	-svinf, -svinfex	Yes	Yes	Yes	Yes
	-gplba, -gplbaex	No	No	No	No
	-fv	Yes	Yes	Yes	Yes
	-fp	No	No	No	No
	-fl	Yes	Yes	Yes	Yes
	-pin	No	No	No	No
	-fg	Yes	Yes	Yes	Yes
	-CLIB -sort	No	No	No	No
	-fh[c]	No	No	No	No
	-CLI -fn	No	No	No	No
	-CLI -export	No	No	No	No
-fr	No	No	No	No	
-fe	No	No	No	No	
mkconf	-g <group>	Yes	Yes	Yes	Yes
	-gg	Yes	Yes	Yes	Yes
	-m <mu#>	Yes	Yes	Yes	Yes
	-i <inst#>	Yes	Yes	Yes	Yes
	-s <service>	Yes	Yes	Yes	Yes
	-a	Yes	Yes	Yes	Yes
	-c <drive#>	Yes	Yes	Yes	Yes

Table 4-1: Command Options for Copy Types (Continued)

Command	Options	Shadow-Image	Snap-Shot	True-Copy	TCE
rmawk	-h	No	No	No	No
	exe="command_line"	No	No	No	No
	exe="print ..."	No	No	No	No
	exe="printn ..." or exe="prints ..."	No	No	No	No
	exe=exit	No	No	No	No
	sys="command_line"	No	No	No	No
	timeout=value	No	No	No	No
	interval=value	No	No	No	No
	-BL	No	No	No	No
	-AT	No	No	No	No
	-EC[VAL]	No	No	No	No
	@variable	No	No	No	No
	operators (-operator:)	No	No	No	No
	operators (=operator:)	No	No	No	No
	operators (-operator)	No	No	No	No
raidcom * copy_grp		No	No	No	No
raidcom * device_grp		No	No	No	No
raidcom * external_grp		No	No	No	No
raidcom * external_storage		No	No	No	No
raidcom * host_grp		No	No	No	No
raidcom * hba_wwn		No	No	No	No
raidcom * journal		No	No	No	No
raidcom * ldev		No	No	No	No
raidcom * lun		No	No	No	No
raidcom * path		No	No	No	No
raidcom * pool		No	No	No	No
raidcom * port		No	No	No	No
raidcom * parity_grp		No	No	No	No
raidcom * rcu		No	No	No	No
raidcom * rcu_path		No	No	No	No
raidcom * resource		No	No	No	No
raidcom * snap_pool		No	No	No	No
raidcom * ssid		No	No	No	No
raidcom * dp_pool		No	No	No	No
raidcom * pool		No	No	No	No
raidcom * command_status		No	No	No	No
raidcom * error_message		No	No	No	No
raidcom * clpr		No	No	No	No
raidcom * copy_grp		No	No	No	No

Table 4-1: Command Options for Copy Types (Continued)

Command	Options	Shadow-Image	Snap-Shot	True-Copy	TCE
raidcom * spm_wwn		No	No	No	No
raidcom * spm_group		No	No	No	No
raidcom * snapshot		No	No	No	No



Glossary

This glossary provides definitions for replication terms as well as terms related to the technology that supports CCI and AMS. Click the letter of the glossary section to display the related page.

A	B	C	D	E	F	G	H	I	J	K	L	M	N	O	P	Q	R	S	T	U	V	W	X	Y	Z
-------------------	-------------------	-------------------	-------------------	-------------------	-------------------	-------------------	-------------------	-------------------	-------------------	-------------------	-------------------	-------------------	-------------------	-------------------	-------------------	-------------------	-------------------	-------------------	-------------------	-------------------	-------------------	-------------------	-------------------	-------------------	-------------------

A

array

A set of hard disks mounted in a single enclosure and grouped logically together to function as one contiguous storage space.

asynchronous

Asynchronous data communications operate between a computer and various devices. Data transfers occur intermittently rather than in a steady stream. Asynchronous replication does not depend on acknowledging the remote write, but it does write to a local log file. Synchronous replication depends on receiving an acknowledgement code (ACK) from the remote system and the remote system also keeps a log file.

B

background copy

A physical copy of all tracks from the source volume to the target volume.

bps

Bits per second. The standard measure of data transmission speeds.

C

cache

A temporary, high-speed storage mechanism. It is a reserved section of main memory or an independent high-speed storage device. Two types of caching are found in computers: memory caching and disk caching. Memory caches are built into the architecture of microprocessors and often computers have external cache memory. Disk caching works like memory caching; however, it uses slower, conventional main memory that on some devices is called a memory buffer.

capacity

The amount of information (usually expressed in megabytes) that can be stored on a disk drive. It is the measure of the potential contents of a device; the volume it can contain or hold. In communications, capacity refers to the maximum possible data transfer rate of a communications channel under ideal conditions.

CCI

See command control interface.

A	B	C	D	E	F	G	H	I	J	K	L	M	N	O	P	Q	R	S	T	U	V	W	X	Y	Z
---	---	---	---	---	---	---	---	---	---	---	---	---	---	---	---	---	---	---	---	---	---	---	---	---	---

Glossary–2

CLI

See command line interface.

cluster

A group of disk sectors. The operating system assigns a unique number to each cluster and then keeps track of files according to which clusters they use.

cluster capacity

The total amount of disk space in a cluster, excluding the space required for system overhead and the operating system. Cluster capacity is the amount of space available for all archive data, including original file data, metadata, and redundant data.

command control interface (CCI)

Hitachi's Command Control Interface software provides command line control of Hitachi array and software operations through the use of commands issued from a system host. Hitachi's CCI also provides a scripting function for defining multiple operations.

command devices

Dedicated logical volumes that are used only by management software such as CCI, to interface with the storage systems. Command devices are not used by ordinary applications. Command devices can be shared between several hosts.

command line interface (CLI)

A method of interacting with an operating system or software using a command line interpreter. With Hitachi's Storage Navigator Modular Command Line Interface, CLI is used to interact with and manage Hitachi storage and replication systems.

concurrency of S-VOL

Occurs when an S-VOL is synchronized by simultaneously updating an S-VOL with P-VOL data AND data cached in the primary host memory. Discrepancies in S-VOL data may occur if data is cached in the primary host memory between two write operations. This data, which is not available on the P-VOL, is not reflected on to the S-VOL. To ensure concurrency of the S-VOL, cached data is written onto the P-VOL before subsequent remote copy operations take place.

concurrent copy

A management solution that creates data dumps, or copies, while other applications are updating that data. This allows end-user processing to continue. Concurrent copy allows you to update the data in the files being copied, however, the copy or dump of the data it secures does not contain any of the intervening updates.

A	B	C	D	E	F	G	H	I	J	K	L	M	N	O	P	Q	R	S	T	U	V	W	X	Y	Z
---	---	---	---	---	---	---	---	---	---	---	---	---	---	---	---	---	---	---	---	---	---	---	---	---	---

configuration definition file

The configuration definition file describes the system configuration for making CCI operational in a TrueCopy Extended Distance Software environment. The configuration definition file is a text file created or edited using any standard text editor, and can be defined from the PC where the CCI software is installed. The configuration definition file describes configuration of new TrueCopy Extended Distance pairs on the primary or remote storage system.

consistency group (CTG)

A group of two or more logical units in a file system or a logical volume. When a file system or a logical volume which stores application data, is configured from two or more logical units, these multiple logical units are managed as a consistency group (CTG) and treated as a single entity. A set of volume pairs can also be managed and operated as a consistency group.

consistency of S-VOL

A state in which a reliable copy of S-VOL data from a previous update cycle is available at all times on the remote storage system. A consistent copy of S-VOL data is internally pre-determined during each update cycle and maintained in the remote data pool. When remote takeover operations are performed, this reliable copy is restored to the S-VOL, eliminating any data discrepancies. Data consistency at the remote site enables quicker restart of operations upon disaster recovery.

CRC

Cyclical Redundancy Checking. A scheme for checking the correctness of data that has been transmitted or stored and retrieved. A CRC consists of a fixed number of bits computed as a function of the data to be protected, and appended to the data. When the data is read or received, the function is recomputed, and the result is compared to that appended to the data.

CTG

See Consistency Group.

cycle time

A user specified time interval used to execute recurring data updates for remote copying. Cycle time updates are set for each storage system and are calculated based on the number of consistency groups CTG.

cycle update

Involves periodically transferring differential data updates from the P-VOL to the S-VOL. TrueCopy Extended Distance Software remote replication processes are implemented as recurring cycle update operations executed in specific time periods (cycles).

A	B	C	D	E	F	G	H	I	J	K	L	M	N	O	P	Q	R	S	T	U	V	W	X	Y	Z
---	---	---	---	---	---	---	---	---	---	---	---	---	---	---	---	---	---	---	---	---	---	---	---	---	---

Glossary–4

D

data pool

One or more disk volumes designated to temporarily store untransferred differential data (in the local storage system or snapshots of backup data in the remote storage system). The saved snapshots are useful for accurate data restoration (of the P-VOL) and faster remote takeover processing (using the S-VOL).

data volume

A volume that stores database information. Other files, such as index files and data dictionaries, store administrative information (metadata).

differential data control

The process of continuously monitoring the differences between the data on two volumes and determining when to synchronize them.

differential data copy

The process of copying the updated data from the primary volume to the secondary volume. The data is updated from the differential data control status (the pair volume is under the suspended status) to the primary volume.

Differential Management Logical Unit (DMLU)

The volumes used to manage differential data in a storage system. In a TrueCopy Extended Distance system, there may be up to two DM logical units configured per storage system. For Copy-on-Write and ShadowImage, the DMLU is an exclusive volume used for storing data when the array system is powered down.

differential-data

The original data blocks replaced by writes to the primary volume. In Copy-on-Write, differential data is stored in the data pool to preserve the copy made of the P-VOL to the time of the snapshot.

disaster recovery

A set of procedures to recover critical application data and processing after a disaster or other failure. Disaster recovery processes include failover and fallback procedures.

disk array

An enterprise storage system containing multiple disk drives. Also referred to as "disk array device" or "disk storage system."

DMLU

See Differential Management-Logical Unit.

A	B	C	D	E	F	G	H	I	J	K	L	M	N	O	P	Q	R	S	T	U	V	W	X	Y	Z
---	---	---	---	---	---	---	---	---	---	---	---	---	---	---	---	---	---	---	---	---	---	---	---	---	---

dual copy

The process of simultaneously updating a P-VOL and S-VOL while using a single write operation.

duplex

The transmission of data in either one or two directions. Duplex modes are full-duplex and half-duplex. Full-duplex is the simultaneous transmission of data in two directions. For example, a telephone is a full-duplex device, because both parties can talk at once. In contrast, a walkie-talkie is a half-duplex device because only one party can transmit at a time.

E**entire copy**

Copies all data in the primary volume to the secondary volume to make sure that both volumes are identical.

extent

A contiguous area of storage in a computer file system that is reserved for writing or storing a file.

F**failover**

The automatic substitution of a functionally equivalent system component for a failed one. The term failover is most often applied to intelligent controllers connected to the same storage devices and host computers. If one of the controllers fails, failover occurs, and the survivor takes over its I/O load.

fallback

Refers to the process of restarting business operations at a local site using the P-VOL. It takes place after the storage systems have been recovered.

Fault tolerance

A system with the ability to continue operating, possibly at a reduced level, rather than failing completely, when some part of the system fails.

FC

See fibre channel.

A	B	C	D	E	F	G	H	I	J	K	L	M	N	O	P	Q	R	S	T	U	V	W	X	Y	Z
---	---	---	---	---	---	---	---	---	---	---	---	---	---	---	---	---	---	---	---	---	---	---	---	---	---

fibre channel

A gigabit-speed network technology primarily used for storage networking.

firmware

Software embedded into a storage device. It may also be referred to as Microcode.

full duplex

The concurrent transmission and the reception of data on a single link.

G**Gbps**

Gigabit per second.

granularity of differential data

Refers to the size or amount of data transferred to the S-VOL during an update cycle. Since only the differential data in the P-VOL is transferred to the S-VOL, the size of data sent to S-VOL is often the same as that of data written to the P-VOL. The amount of differential data that can be managed per write command is limited by the difference between the number of incoming host write operations (inflow) and outgoing data transfers (outflow).

GUI

Graphical user interface.

I**I/O**

Input/output.

initial copy

An initial copy operation involves copying all data in the primary volume to the secondary volume prior to any update processing. Initial copy is performed when a volume pair is created.

initiator ports

A port-type used for main control unit port of Fibre Remote Copy function.

IOPS

I/O per second.

A	B	C	D	E	F	G	H	I	J	K	L	M	N	O	P	Q	R	S	T	U	V	W	X	Y	Z
---	---	---	---	---	---	---	---	---	---	---	---	---	---	---	---	---	---	---	---	---	---	---	---	---	---

iSCSI

Internet-Small Computer Systems Interface. A TCP/IP protocol for carrying SCSI commands over IP networks.

iSNS

Internet-Small Computer Systems Interface. A TCP/IP protocol for carrying SCSI commands over IP networks.

L

LAN

Local Area Network. A computer network that spans a relatively small area, such as a single building or group of buildings.

load

In UNIX computing, the system load is a measure of the amount of work that a computer system is doing.

logical

Describes a user's view of the way data or systems are organized. The opposite of logical is physical, which refers to the real organization of a system. A logical description of a file is that it is a quantity of data collected together in one place. The file appears this way to users. Physically, the elements of the file could live in segments across a disk.

logical unit

See logical unit number.

logical unit number (LUN)

An address for an individual disk drive, and by extension, the disk device itself. Used in the SCSI protocol as a way to differentiate individual disk drives within a common SCSI target device, like a disk array. LUNs are normally not entire disk drives but virtual partitions (or volumes) of a RAID set.

LU

Logical unit.

LUN

See logical unit number.

LUN Manager

This storage feature is operated through Storage Navigator Modular 2 software and manages access paths among host and logical units for each port in your array.

A	B	C	D	E	F	G	H	I	J	K	L	M	N	O	P	Q	R	S	T	U	V	W	X	Y	Z
-------------------	-------------------	-------------------	-------------------	-------------------	-------------------	-------------------	-------------------	-------------------	-------------------	-------------------	-------------------	-------------------	-------------------	-------------------	-------------------	-------------------	-------------------	-------------------	-------------------	-------------------	-------------------	-------------------	-------------------	-------------------	-------------------

M

metadata

In sophisticated data systems, the metadata -- the contextual information surrounding the data -- will also be very sophisticated, capable of answering many questions that help understand the data.

microcode

The lowest-level instructions directly controlling a microprocessor. Microcode is generally hardwired and cannot be modified. It is also referred to as firmware embedded in a storage subsystem.

Microsoft Cluster Server

Microsoft Cluster Server is a clustering technology that supports clustering of two NT servers to provide a single fault-tolerant server.

mount

To mount a device or a system means to make a storage device available to a host or platform.

mount point

The location in your system where you mount your file systems or devices. For a volume that is attached to an empty folder on an NTFS file system volume, the empty folder is a mount point. In some systems a mount point is simply a directory.

P

pair

Refers to two logical volumes that are associated with each other for data management purposes (for example, replication, migration). A pair is usually composed of a primary or source volume and a secondary or target volume as defined by you.

pair splitting

The operation that splits a pair. When a pair is "Paired", all data written to the primary volume is also copied to the secondary volume. When the pair is "Split", the primary volume continues being updated, but data in the secondary volume remains as it was at the time of the split, until the pair is re-synchronized.

pair status

Internal status assigned to a volume pair before or after pair operations. Pair status transitions occur when pair operations are performed or as a result of failures. Pair statuses are used to monitor copy operations and detect system failures.

A	B	C	D	E	F	G	H	I	J	K	L	M	N	O	P	Q	R	S	T	U	V	W	X	Y	Z
---	---	---	---	---	---	---	---	---	---	---	---	---	---	---	---	---	---	---	---	---	---	---	---	---	---

paired volume

Two volumes that are paired in a disk array.

parity

The technique of checking whether data has been lost or corrupted when it's transferred from one place to another, such as between storage units or between computers. It is an error detection scheme that uses an extra checking bit, called the parity bit, to allow the receiver to verify that the data is error free. Parity data in a RAID array is data stored on member disks that can be used for regenerating any user data that becomes inaccessible.

parity groups

RAID groups can contain single or multiple parity groups where the parity group acts as a partition of that container.

peer-to-peer remote copy (PPRC)

A hardware-based solution for mirroring logical volumes from a primary site (the application site) onto the volumes of a secondary site (the recovery site).

point-in-time logical copy

A logical copy or snapshot of a volume at a point in time. This enables a backup or mirroring application to run concurrently with the system.

pool volume

Used to store backup versions of files, archive copies of files, and files migrated from other storage.

primary or local site

The host computer where the primary volume of a remote copy pair (primary and secondary volume) resides. The term "primary site" is also used for host failover operations. In that case, the primary site is the host computer where the production applications are running, and the secondary site is where the backup applications run when the applications on the primary site fail, or where the primary site itself fails.

primary volume (P-VOL)

The storage volume in a volume pair. It is used as the source of a copy operation. In copy operations a copy source volume is called the P-VOL while the copy destination volume is called "S-VOL" (secondary volume).

P-VOL

See primary volume.

A	B	C	D	E	F	G	H	I	J	K	L	M	N	O	P	Q	R	S	T	U	V	W	X	Y	Z
---	---	---	---	---	---	---	---	---	---	---	---	---	---	---	---	---	---	---	---	---	---	---	---	---	---

R

RAID

Redundant Array of Independent Disks. A disk array in which part of the physical storage capacity is used to store redundant information about user data stored on the remainder of the storage capacity. The redundant information enables regeneration of user data in the event that one of the array's member disks or the access path to it fails.

Recovery Point Objective (RPO)

After a recovery operation, the RPO is the maximum desired time period, prior to a disaster, in which changes to data may be lost. This measure determines up to what point in time data should be recovered. Data changes preceding the disaster are preserved by recovery.

Recovery Time Objective (RTO)

The maximum desired time period allowed to bring one or more applications, and associated data back to a correct operational state. It defines the time frame within which specific business operations or data must be restored to avoid any business disruption.

remote or target site

Maintains mirrored data from the primary site.

remote path

A route connecting identical ports on the local storage system and the remote storage system. Two remote paths must be set up for each storage system (one path for each of the two controllers built in the storage system).

remote volume stem

In TrueCopy operations, the remote volume (R-VOL) is a volume located in a different subsystem from the primary host subsystem.

resynchronization

Refers to the data copy operations performed between two volumes in a pair to bring the volumes back into synchronization. The volumes in a pair are synchronized when the data on the primary and secondary volumes is identical.

RPO

See Recovery Point Objective.

RTO

See Recovery Time Objective.

A	B	C	D	E	F	G	H	I	J	K	L	M	N	O	P	Q	R	S	T	U	V	W	X	Y	Z
---	---	---	---	---	---	---	---	---	---	---	---	---	---	---	---	---	---	---	---	---	---	---	---	---	---

S

SAS

Serial Attached SCSI, an evolution of parallel SCSI into a point-to-point serial peripheral interface in which controllers are linked directly to disk drives. SAS delivers improved performance over traditional SCSI because SAS enables up to 128 devices of different sizes and types to be connected simultaneously.

SATA

Serial ATA is a computer bus technology primarily designed for the transfer of data to and from hard disks and optical drives. SATA is the evolution of the legacy Advanced Technology Attachment (ATA) interface from a parallel bus to serial connection architecture.

secondary volume (S VOL)

A replica of the primary volume (P-VOL) at the time of a backup and is kept on a standby storage system. Recurring differential data updates are performed to keep the data in the S-VOL consistent with data in the P-VOL.

SMPL

Simplex.

snapshot

A term used to denote a copy of the data and data-file organization on a node in a disk file system. A snapshot is a replica of the data as it existed at a particular point in time.

SNM2

See Storage Navigator Modular 2.

Storage Navigator Modular 2

A multi-featured scalable storage management application that is used to configure and manage the storage functions of Hitachi arrays. Also referred to as "Navigator 2".

suspended status

Occurs when the update operation is suspended while maintaining the pair status. During suspended status, the differential data control for the updated data is performed in the primary volume.

S-VOL

See secondary volume.

A	B	C	D	E	F	G	H	I	J	K	L	M	N	O	P	Q	R	S	T	U	V	W	X	Y	Z
---	---	---	---	---	---	---	---	---	---	---	---	---	---	---	---	---	---	---	---	---	---	---	---	---	---

S-VOL determination

Independent of update operations, S-VOL determination replicates the S-VOL on the remote storage system. This process occurs at the end of each update cycle and a pre-determined copy of S-VOL data, consistent with P-VOL data, is maintained on the remote site at all times.

T

target copy

A file, device, or any type of location to which data is moved or copied.

V

virtual volume (V-VOL)

In Copy-on-Write, a secondary volume in which a view of the primary volume (P-VOL) is maintained as it existed at the time of the last snapshot. The V-VOL contains no data but is composed of pointers to data in the P-VOL and the data pool. The V-VOL appears as a full volume copy to any secondary host.

volume

A disk array object that most closely resembles a physical disk from the operating environment's viewpoint. The basic unit of storage as seen from the host.

volume copy

Copies all data from the P-VOL to the S-VOL.

volume pair

Formed by pairing two logical data volumes. It typically consists of one primary volume (P-VOL) on the local storage system and one secondary volume (S-VOL) on the remote storage systems.

V-VOL

See virtual volume.

V-VOLTL

Virtual Volume Tape Library.

W

WMS

Workgroup Modular Storage.

A	B	C	D	E	F	G	H	I	J	K	L	M	N	O	P	Q	R	S	T	U	V	W	X	Y	Z
---	---	---	---	---	---	---	---	---	---	---	---	---	---	---	---	---	---	---	---	---	---	---	---	---	---

write order guarantee

Ensures that data is updated in an S-VOL, in the same order that it is updated in the P-VOL, particularly when there are multiple write operations in one update cycle. This feature is critical to maintain data consistency in the remote S-VOL and is implemented by inserting sequence numbers in each update record. Update records are then sorted in the cache within the remote system, to assure write sequencing.

write workload

The amount of data written to a volume over a specified period of time.

A	B	C	D	E	F	G	H	I	J	K	L	M	N	O	P	Q	R	S	T	U	V	W	X	Y	Z
---	---	---	---	---	---	---	---	---	---	---	---	---	---	---	---	---	---	---	---	---	---	---	---	---	---

Index

C

- cluster manager [2-17](#)
- command execution environment [1-4](#), [1-84](#)
- command options [4-2](#)
- commands
 - drivescan [1-74](#)
 - findcmdev [1-73](#)
 - horcctl [1-70](#)
 - horcmshutdown [1-70](#)
 - horcmstart [1-68](#)
 - inraid [1-85](#)
 - mkconf [1-93](#)
 - mount [1-78](#)
 - pairdisplay [1-34](#)
 - pairmon [1-29](#)
 - pairsplit [1-14](#)
 - pairsplit -E [1-16](#)
 - pairsplit -S [1-16](#)
 - pairvolchk [1-31](#)
 - portscan [1-75](#)
 - raidar [1-57](#)
 - raidqry [1-58](#)
 - raidsan [1-51](#)
 - raidvchkdsp [1-62](#)
 - raidvchkscan [1-66](#)
 - raidvchkset [1-60](#)
 - sync [1-76](#)
 - syncd [1-76](#)
 - umount [1-81](#)

D

- data assurance [2-31](#), [2-33](#)
- data recovery procedure for PSUE status [2-31](#), [2-33](#)
- displaying configuration information [1-51](#)
- displaying pair status [1-34](#)

E

- environment variable
 - ShadowImage command [1-4](#)

- environment variable subcommands [1-83](#)
- environment variables
 - CCI command [1-4](#), [1-86](#)
 - CCI instance [1-4](#)
 - HORCM (/etc/horcmgr) [1-3](#)
- error
 - command error messages [2-21](#)
 - common error messages [2-27](#), [2-29](#)
 - unique error messages [2-30](#)
- error reporting [2-19](#)

F

- fence level [2-16](#)
- findcmdev [1-73](#)
- flushing [1-56](#)
- fsck [1-19](#), [1-20](#)

H

- HA [2-16](#), [2-17](#)
- HORCC LOG [3-4](#)
- HORCC_LOG [1-4](#)
- HORCC_MRCF [1-4](#)
- HORCC_MRCF setting [1-84](#)
- HORCC_TRCBUF [1-4](#)
- HORCC_TRCLVL [1-4](#)
- HORCC_TRCSZ [1-4](#)
- HORCCINST [1-4](#)
- horcctl [1-70](#)
- HORCM LOG [3-4](#)
- HORCM_CONF [1-3](#)
- HORCM_LOG [1-3](#)
- HORCM_TRCBUF [1-3](#)
- HORCM_TRCLVL [1-3](#)
- HORCM_TRCSZ [1-3](#)
- HORCM_TRCUENV [1-3](#)
- HORCMFCTBL [1-3](#)
- HORCMPerm [1-3](#)
- HORCMPORMOD [1-3](#)
- horcmshutdown [1-70](#)
- horcmstart [1-68](#)

I

inqraid 1-85
Internet Protocol version 6 (IPv6) ii-xii

L

lock disk for HA software 2-17
log directories 3-4
log files
 core 3-3
 error 3-3
 start-up 3-3
 trace 3-3
LU number and device number 2-32
LVM 2-16, 2-17

M

maintenance notes 2-2, 2-4
messages
 command error 2-21
 common error 2-27, 2-29
 system log 2-19
 unique error 2-30
mkconf 1-93
mount 1-78

O

offline backup 1-19
online backup 1-19
options per copy type 4-2

P

pair recovering 2-31, 2-33
pairedisplay 1-34
pairsplit
 timing 1-19
pairsplit -E 1-16
pairsplit -S 1-16
pairvolchk 1-31
port number 1-93
portscan 1-75
procedure for recovering data 2-31, 2-33
protected volumes 1-3
protection function 2-32

R

raidar 1-57
raidqry 1-58
raidscan 1-51
raidvchkdsp 1-62
raidvchkscan 1-66
raidvchkset 1-60
recovering data 2-31, 2-33
recovering the pair 2-31, 2-33

S

sense codes 3-9

setting
 environment variables 2-16, 3-2
special files 1-85, 1-93
status transition 1-29, 3-2
status transition queue 1-29
subcommands 1-73, 1-83
 for environment variable 1-83
 for Windows® 2000/Windows Server 2003/
 Windows Server 2008 1-73
supported operating systems ii-xii
suspended pairs
 recovering 2-31, 2-33
suspending pairs 1-16
sync 1-76
syncd 1-76

T

timing of pairsplit operations 1-19

U

umount 1-81

V

volume migration 1-98

Index-2

Hitachi Data Systems

Corporate Headquarters

2845 Lafayette Street
Santa Clara, California 95050-2639
U.S.A.
www.hds.com

Regional Contact Information

Americas

+1 408 970 1000
info@hds.com

Europe, Middle East, and Africa

+44 (0)1753 618000
info.emea@hds.com

Asia Pacific

+852 3189 7900
hds.marketing.apac@hds.com



MK-97DF8121-19