



# Hitachi Compatible FlashCopy®

User Guide

Hitachi Virtual Storage Platform G1000 and G1500

Hitachi Virtual Storage Platform F1500

© 2014, 2017 Hitachi, Ltd. All rights reserved.

No part of this publication may be reproduced or transmitted in any form or by any means, electronic or mechanical, including copying and recording, or stored in a database or retrieval system for commercial purposes without the express written permission of Hitachi, Ltd., or Hitachi Data Systems Corporation (collectively "Hitachi"). Licensee may make copies of the Materials provided that any such copy is: (i) created as an essential step in utilization of the Software as licensed and is used in no other manner; or (ii) used for archival purposes. Licensee may not make any other copies of the Materials. "Materials" mean text, data, photographs, graphics, audio, video and documents.

Hitachi reserves the right to make changes to this Material at any time without notice and assumes no responsibility for its use. The Materials contain the most current information available at the time of publication.

Some of the features described in the Materials might not be currently available. Refer to the most recent product announcement for information about feature and product availability, or contact Hitachi Data Systems Corporation at [https://support.hds.com/en\\_us/contact-us.html](https://support.hds.com/en_us/contact-us.html).

**Notice:** Hitachi products and services can be ordered only under the terms and conditions of the applicable Hitachi agreements. The use of Hitachi products is governed by the terms of your agreements with Hitachi Data Systems Corporation.

By using this software, you agree that you are responsible for:

1. Acquiring the relevant consents as may be required under local privacy laws or otherwise from authorized employees and other individuals to access relevant data; and
2. Verifying that data continues to be held, retrieved, deleted, or otherwise processed in accordance with relevant laws.

**Notice on Export Controls.** The technical data and technology inherent in this Document may be subject to U.S. export control laws, including the U.S. Export Administration Act and its associated regulations, and may be subject to export or import regulations in other countries. Reader agrees to comply strictly with all such regulations and acknowledges that Reader has the responsibility to obtain licenses to export, re-export, or import the Document and any Compliant Products.

Hitachi is a registered trademark of Hitachi, Ltd., in the United States and other countries.

AIX, AS/400e, DB2, Domino, DS6000, DS8000, Enterprise Storage Server, eServer, FICON, FlashCopy, IBM, Lotus, MVS, OS/390, PowerPC, RS/6000, S/390, System z9, System z10, Tivoli, z/OS, z9, z10, z13, z/VM, and z/VSE are registered trademarks or trademarks of International Business Machines Corporation.

Active Directory, ActiveX, Bing, Excel, Hyper-V, Internet Explorer, the Internet Explorer logo, Microsoft, the Microsoft Corporate Logo, MS-DOS, Outlook, PowerPoint, SharePoint, Silverlight, SmartScreen, SQL Server, Visual Basic, Visual C++, Visual Studio, Windows, the Windows logo, Windows Azure, Windows PowerShell, Windows Server, the Windows start button, and Windows Vista are registered trademarks or trademarks of Microsoft Corporation. Microsoft product screen shots are reprinted with permission from Microsoft Corporation.

All other trademarks, service marks, and company names in this document or website are properties of their respective owners.



# Contents

Preface .....	9
Intended audience.....	10
Product version.....	10
Release notes.....	10
Changes in this revision.....	10
Related documents.....	10
Document conventions.....	11
Conventions for storage capacity values.....	12
Accessing product documentation.....	12
Getting help.....	13
Comments.....	13
<b>1 Hitachi Compatible FlashCopy® overview.....</b>	<b>15</b>
About Hitachi Compatible FlashCopy®.....	17
Compatibility between Compatible FlashCopy® and mainframe host interfaces.....	18
Overview of Compatible FlashCopy® relationships.....	19
About Compatible FlashCopy® V2 relationships.....	19
About Compatible FlashCopy® SE relationships.....	21
Copy modes.....	21
On-demand copy.....	22
Write request to an area of the source volume not yet copied to the target....	22
Read or write request to an area of the target volume not yet copied.....	24
Copying by volume.....	26
Copying by dataset (Compatible FlashCopy® V2 only).....	26
Using consistency groups for dataset copies that span volumes.....	27
Incremental FlashCopy® (Compatible FlashCopy® V2 only).....	28
Reverse Restore (Compatible FlashCopy® V2 only).....	30
Fast Reverse Restore .....	31
FlashCopy® to PPRC Primary Volume (Compatible FlashCopy® V2 only).....	33
Copy operation between FlashCopy® relationships and TCz pairs (Compatible FlashCopy® V2 only).....	34
Remote FlashCopy®.....	37

Combining Remote FlashCopy® functions with other Compatible FlashCopy® functions.....	39
FlashCopy® to URz Primary Volume (Compatible FlashCopy® V2 only).....	39
Preserve Mirror FlashCopy® (Compatible FlashCopy® V2 only).....	40
Copy operation of Compatible FlashCopy® V2 relationships and TCz pairs (Compatible FlashCopy® V2 only).....	42
Options required for the Preserve Mirror FlashCopy® function (Compatible FlashCopy® V2 only).....	45
Releasing Compatible FlashCopy® relationships.....	45
Optimizing volumes.....	46
<b>2 Interoperability with other products.....</b>	<b>47</b>
Compatible and incompatible products.....	48
Available operations on Compatible FlashCopy® volumes.....	48
Relationships with volumes used by other products.....	48
Compatibility of volumes shared by Compatible FlashCopy® and other products.....	49
External volumes.....	50
Reverse Restore and Fast Reverse Restore when a Compatible FlashCopy® volume is used as volume of other products.....	50
Restricted volumes.....	51
Using Compatible FlashCopy® with ShadowImage for Mainframe.....	51
Using Compatible FlashCopy® with TrueCopy for Mainframe.....	53
Volumes that can be shared.....	53
Volumes that cannot be shared.....	54
Sharing a Compatible FlashCopy® S-VOL and a TCz volume.....	55
Using a volume as both a Compatible FlashCopy® V2 T-VOL and a TCz P-VOL.....	58
Using commands to share Compatible FlashCopy® V2 and TCz volumes.....	59
Using DFSMS commands to share Compatible FlashCopy® V2 and TCz volumes.....	59
Using TSO commands to share Compatible FlashCopy® V2 and TCz volumes.....	59
Using ICKDSF commands to share Compatible FlashCopy® V2 and TCz volumes.....	60
Using Compatible FlashCopy® with Universal Replicator for Mainframe.....	61
Using a Compatible FlashCopy® S-VOL as a URz P-VOL.....	61
Using a Compatible FlashCopy® T-VOL as a URz P-VOL.....	61
Using Compatible FlashCopy® with Concurrent Copy and Extended Remote Copy.....	62
Using Compatible FlashCopy® with Dynamic Provisioning for Mainframe.....	62
Using Compatible FlashCopy® with Resource Partition Manager.....	63
Using Compatible FlashCopy® with Virtual LVI.....	63
<b>3 Preparing for Compatible FlashCopy® operations.....</b>	<b>65</b>
Requirements for using Compatible FlashCopy®.....	66
Compatible FlashCopy® Options.....	66
FC Slower Copy1 option.....	67
FC Slower Copy2 option.....	67
FC Ext. Slower Copy1 option.....	68
FC Ext. Slower Copy2 option.....	68
Powering off the storage system during Compatible FlashCopy®.....	68
Installing and removing Compatible FlashCopy®.....	69

Installing Compatible FlashCopy®.....	69
Removing Compatible FlashCopy®.....	70
License capacity requirements.....	71
License capacity for Compatible FlashCopy® V2.....	71
License capacity for HCFCSE.....	71
<b>4 Performing Compatible FlashCopy® V2 operations.....</b>	<b>73</b>
Commands for Compatible FlashCopy® V2.....	74
Supported operating systems for Compatible FlashCopy® V2.....	75
Setting local replica options.....	75
Establishing relationships for Compatible FlashCopy® V2.....	76
Using PPRC TSO to establish Compatible FlashCopy® V2 relationships by volume .....	76
Using DFSMSdss to establish Compatible FlashCopy® V2 relationships by volume .....	79
Using ICKDSF to establish Compatible FlashCopy® V2 relationships by volume.....	82
Compatible FlashCopy® V2 Reverse Restore using the ICKDSF FLASHCPY ESTABLISH command.....	85
Compatible FlashCopy® V2 Fast Reverse Restore using the ICKDSF FLASHCPY ESTABLISH command.....	86
Compatible FlashCopy® V2 Incremental Restore using the ICKDSF FLASHCPY ESTABLISH command .....	86
Using the ANTRQST macro to establish Compatible FlashCopy® V2 relationships by volume.....	87
Establishing Compatible FlashCopy® V2 relationships by extent.....	90
Using TSO to establish Compatible FlashCopy® V2 relationships by extent.....	90
Using DFSMSdss to establish Compatible FlashCopy® V2 relationships by extent .....	93
Using ANTRQST macro to establish Compatible FlashCopy® V2 relationships by extent.....	93
Using z/VM CP to establish Compatible FlashCopy® V2 relationships.....	94
Using z/VM FlashCopy® to establish relationships.....	94
Using z/VM FLASHCOPY ESTABLISH to establish relationships.....	95
Using z/VM FLASHCOPY BACKGNDCOPY to start the background copy operation...	96
Using z/VM FLASHCOPY RESYNC to re-establish relationships.....	97
Using the z/VM FLASHCOPY TGTWRITE command to remove write-protection from a T-VOL.....	98
Suspending write operations to S-VOLs when establishing Compatible FlashCopy® V2 relationships.....	98
Changing the SCP time.....	99
Viewing details of Compatible FlashCopy® V2 relationships.....	99
Using TSO FCQUERY to view Compatible FlashCopy® V2 relationship details.....	100
Using ICKDSF to view details of Compatible FlashCopy® V2 relationships.....	105
Displaying information about relationships: FLASHCPY QUERY.....	106
Displaying information about Compatible FlashCopy® V2 relationships: FLASHCPY QUERY RELATIONS.....	107
Using ANTRQST macro to view the state of Compatible FlashCopy® V2 relationships .....	110
Using z/VM CP to view the state of Compatible FlashCopy® V2 relationships.....	111
Viewing resource information from Device Manager - Storage Navigator.....	112
Viewing consistency group information.....	112

Viewing relationship operations history .....	112
History window messages for Compatible FlashCopy® V2.....	113
History window messages for HCFCSE.....	114
Releasing Compatible FlashCopy® V2 relationships.....	115
Using PPRC TSO to release Compatible FlashCopy® V2 relationships.....	116
Case 1: TDEVN specified, DDSW = NO.....	119
Case 2: TDEVN specified, DDSW = NO, XTNTLST or XXTNTLST parameter specified.....	120
Case 3: SDEVN and TDEVN specified, DDSW = NO.....	122
Case 4: SDEVN and TDEVN specified, DDSW = NO, XTNTLST or XXTNTLST parameter specified.....	123
Case 5: SDEVN and TDEVN specified or not specified, DDSW = YES.....	126
Case 6: SDEVN and TDEVN specified or not specified, DDSW = YES, XTNTLST or XXTNTLST parameter specified.....	127
Case 7: DEVN specified, ACTION = THAW.....	128
USING ICKDSF to release Compatible FlashCopy® V2 relationships.....	129
Using FLASHCPY WITHDRAW to release Compatible FlashCopy® V2 relationships.....	130
Using ANTRQST macro to release Compatible FlashCopy® V2 relationships.....	131
Using z/VM CP FLASHCOPY WITHDRAW to release Compatible FlashCopy® V2 relationships.....	132

## 5 Performing Compatible FlashCopy® SE operations..... 135

Overview of Compatible FlashCopy® SE.....	136
Best practice for using Compatible FlashCopy® SE.....	136
Requirements for using Compatible FlashCopy® SE.....	137
Creating pools.....	137
Creating TSE-VOLs for Compatible FlashCopy® SE.....	139
Pool operations and TSE-VOLS.....	141
Operations when a pool is full.....	141
Managing failed states.....	141
Pool capacity warning to the host.....	142
Sharing a pool with DP-VOL.....	142
Establishing HCFCSE relationships.....	142
Maintaining data consistency.....	142
Commands for establishing HCFCSE relationships.....	143
Using PPRC TSO to establish HCFCSE relationships.....	143
Using DFSMSdss to establish HCFCSE relationships.....	144
Using ICKDSF to establish HCFCSE relationships.....	144
Using z/VM CP to establish HCFCSE relationships.....	145
Viewing HCFCSE relationship states.....	145
Using PPRC TSO FCQUERY to view HCFCSE relationship states.....	145
Using ICKDSF FLASHCPY QUERY RELATIONS to view HCFCSE relationship states .....	145
Releasing HCFCSE relationships.....	146
Using PPRC TSO FCWITHDR to release HCFCSE relationships.....	146
Using ICKDSF FLASHCPY WITHDRAW to release HCFCSE relationships.....	147
Using ANTRQST macro FCWITHDRAW to release HCFCSE relationships.....	148
Using z/VM CP FLASHCOPY WITHDRAW to release HCFCSE relationships.....	148
Viewing TSE-VOL or pool information using the IDCAMS LISTDATA command.....	148

<b>6</b>	<b>Hitachi Compatible FlashCopy® and IBM® FlashCopy® feature comparison.....</b>	<b>153</b>
	GLOBAL Mirror status.....	154
	Maximum number of relationships supported.....	154
	Copying operations.....	154
	Withdrawing relationships.....	157
	Comparing IBM® HCFSE and Hitachi Compatible FlashCopy® SE.....	158
	Supporting commands.....	158
	TSO command restrictions.....	158
	ICKDSF command restrictions.....	159
	ANTRQST command restrictions.....	159
	z/VM CP command restrictions.....	159
<b>7</b>	<b>Troubleshooting.....</b>	<b>161</b>
	Compatible FlashCopy® relationship is suspended.....	162
	ICKDSF command terminates abnormally.....	162
	SIM reporting.....	163
	Contacting customer support.....	164
<b>A</b>	<b>Compatible FlashCopy® GUI reference.....</b>	<b>167</b>
	Replication window.....	168
	History window.....	170
	Edit Local Replica Option wizard.....	171
	Edit Local Replica Options window.....	172
	Edit Local Replica Options confirmation window.....	173
	Edit SCP Time wizard.....	174
	Edit SCP Time window.....	174
	Change SCP Time dialog.....	175
	Edit SCP Time confirmation window.....	176
	<b>Index.....</b>	<b>177</b>





# Preface

The Hitachi Compatible FlashCopy/FlashCopy SE User Guide describes and provides instructions for performing Hitachi Compatible FlashCopy® operations on the Hitachi Virtual Storage Platform G1000 (VSP G1000), Hitachi Virtual Storage Platform G1500 (VSP G1500), and Hitachi Virtual Storage Platform F1500 (VSP F1500) storage systems.

Please read this document carefully to understand how to use this product, and maintain a copy for reference purposes.

- [Intended audience](#)
- [Product version](#)
- [Release notes](#)
- [Changes in this revision](#)
- [Related documents](#)
- [Document conventions](#)
- [Conventions for storage capacity values](#)
- [Accessing product documentation](#)
- [Getting help](#)
- [Comments](#)

## Intended audience

This document is intended for system administrators, Hitachi Data Systems representatives, and authorized service providers who install, configure, or operate VSP G1000 and G1500, and VSP F1500 storage systems.

Readers of this document should be familiar with the following:

- Data processing and RAID storage systems and their basic functions
- The IBM® FlashCopy® host software

## Product version

This document revision applies to the following product versions:

- Microcode 80-05-2x or later
- SVOS 7.1 or later

## Release notes

Read the release notes before installing and using this product. They may contain requirements or restrictions that are not fully described in this document or updates or corrections to this document. Release notes are available on Hitachi Data Systems Support Connect: <https://knowledge.hds.com/Documents>.

## Changes in this revision

- Added support for Remote FC Freeze. See [Sharing a Compatible FlashCopy S-VOL and a TCz volume on page 55](#) and [Copying operations on page 154](#).

## Related documents

The documents listed below are referenced in this document or contain more information about the features described in this document.



- *Command Control Interface User and Reference Guide*, MK-90RD7010
- *System Administrator Guide*, MK-92RD8016
- *Hitachi TrueCopy® for Mainframe User Guide*, MK-92RD8018
- *Hitachi Universal Volume Manager User Guide*, MK-92RD8024

## Document conventions

This document uses the following typographic conventions:

Convention	Description
<b>Bold</b>	<ul style="list-style-type: none"> <li>Indicates text in a window, including window titles, menus, menu options, buttons, fields, and labels. Example: Click <b>OK</b>.</li> <li>Indicates emphasized words in list items.</li> </ul>
<i>Italic</i>	<ul style="list-style-type: none"> <li>Indicates a document title or emphasized words in text.</li> <li>Indicates a variable, which is a placeholder for actual text provided by the user or for output by the system. Example: <code>pairdisplay -g group</code></li> </ul> <p>(For exceptions to this convention for variables, see the entry for angle brackets.)</p>
Monospace	Indicates text that is displayed on screen or entered by the user. Example: <code>pairdisplay -g oradb</code>
< > angle brackets	Indicates variables in the following scenarios: <ul style="list-style-type: none"> <li>Variables are not clearly separated from the surrounding text or from other variables. Example: <code>Status-&lt;report-name&gt;&lt;file-version&gt;.csv</code></li> <li>Variables in headings.</li> </ul>
[ ] square brackets	Indicates optional values. Example: [ a   b ] indicates that you can choose a, b, or nothing.
{ } braces	Indicates required or expected values. Example: { a   b } indicates that you must choose either a or b.
vertical bar	Indicates that you have a choice between two or more options or arguments. Examples:  [ a   b ] indicates that you can choose a, b, or nothing.  { a   b } indicates that you must choose either a or b.

This document uses the following icons to draw attention to information:

Icon	Label	Description
	Note	Calls attention to important or additional information.
	Tip	Provides helpful information, guidelines, or suggestions for performing tasks more effectively.
	Caution	Warns the user of adverse conditions and/or consequences (for example, disruptive operations, data loss, or a system crash).

Icon	Label	Description
	WARNING	Warns the user of a hazardous situation which, if not avoided, could result in death or serious injury.

## Conventions for storage capacity values

Physical storage capacity values (for example, disk drive capacity) are calculated based on the following values:

Physical capacity unit	Value
1 kilobyte (KB)	1,000 (10 <sup>3</sup> ) bytes
1 megabyte (MB)	1,000 KB or 1,000 <sup>2</sup> bytes
1 gigabyte (GB)	1,000 MB or 1,000 <sup>3</sup> bytes
1 terabyte (TB)	1,000 GB or 1,000 <sup>4</sup> bytes
1 petabyte (PB)	1,000 TB or 1,000 <sup>5</sup> bytes
1 exabyte (EB)	1,000 PB or 1,000 <sup>6</sup> bytes

Logical capacity values (for example, logical device capacity, cache memory capacity) are calculated based on the following values:

Logical capacity unit	Value
1 block	512 bytes
1 cylinder	Mainframe: 870 KB Open-systems: <ul style="list-style-type: none"> <li>• OPEN-V: 960 KB</li> <li>• Others: 720 KB</li> </ul>
1 KB	1,024 (2 <sup>10</sup> ) bytes
1 MB	1,024 KB or 1,024 <sup>2</sup> bytes
1 GB	1,024 MB or 1,024 <sup>3</sup> bytes
1 TB	1,024 GB or 1,024 <sup>4</sup> bytes
1 PB	1,024 TB or 1,024 <sup>5</sup> bytes
1 EB	1,024 PB or 1,024 <sup>6</sup> bytes

## Accessing product documentation

Product user documentation is available on Hitachi Data Systems Support Connect: <https://knowledge.hds.com/Documents>. Check this site for the most current documentation, including important updates that may have been made after the release of the product.

## Getting help

[Hitachi Data Systems Support Connect](#) is the destination for technical support of products and solutions sold by Hitachi Data Systems. To contact technical support, log on to Hitachi Data Systems Support Connect for contact information: [https://support.hds.com/en\\_us/contact-us.html](https://support.hds.com/en_us/contact-us.html).

[Hitachi Data Systems Community](#) is a global online community for HDS customers, partners, independent software vendors, employees, and prospects. It is the destination to get answers, discover insights, and make connections. **Join the conversation today!** Go to [community.hds.com](https://community.hds.com), register, and complete your profile.

## Comments

Please send us your comments on this document to [doc.comments@hds.com](mailto:doc.comments@hds.com). Include the document title and number, including the revision level (for example, -07), and refer to specific sections and paragraphs whenever possible. All comments become the property of Hitachi Data Systems Corporation.

**Thank you!**



# Hitachi Compatible FlashCopy® overview

Hitachi Compatible FlashCopy® enables you to make point-in-time, full volume copies of data, with the copies immediately available for read or write access. Access to the point-in-time copy of the data on the source volume is through reading the data from the target volume.

The Hitachi Virtual Storage Platform G1000 and G1500, and Virtual Storage Platform F1500 storage system is functionally compatible with the IBM® FlashCopy® V2 and IBM® HCFSE host control functions.

For information about the availability of Virtual Storage Platform F1500, contact your HDS representative.

- [About Hitachi Compatible FlashCopy](#)
- [Compatibility between Compatible FlashCopy and mainframe host interfaces](#)
- [Overview of Compatible FlashCopy relationships](#)
- [Using consistency groups for dataset copies that span volumes](#)
- [Incremental FlashCopy \(Compatible FlashCopy V2 only\)](#)
- [Reverse Restore \(Compatible FlashCopy V2 only\)](#)
- [Fast Reverse Restore](#)
- [FlashCopy to PPRC Primary Volume \(Compatible FlashCopy V2 only\)](#)
- [Remote FlashCopy](#)
- [FlashCopy to URz Primary Volume \(Compatible FlashCopy V2 only\)](#)

- [Preserve Mirror FlashCopy \(Compatible FlashCopy V2 only\)](#)
- [Releasing Compatible FlashCopy relationships](#)
- [Optimizing volumes](#)

## About Hitachi Compatible FlashCopy®

After enabling the Hitachi Compatible FlashCopy® features, you can perform FlashCopy® operations on the storage system by issuing PPRC TSO, DFSMSdss, ICKDSF, or ANTRQST macro commands from the host. You can also monitor FlashCopy® operations from Device Manager - Storage Navigator (HDvM - SN) and from Business Continuity Manager (BCM) and the PPRC command options.

Hitachi Compatible Mirroring for IBM® FlashCopy® V2 (Compatible FlashCopy®) provides FlashCopy® V2 data mirroring compatibility and interoperability for VSP G1000 and G1500, and VSP F1500 storage systems. It also provides dataset-level copy functionality and enables you to make point-in-time, full volume copies of data, with the copies immediately available for read or write access. Access to the point-in-time copy of the data on the source volume is achieved through reading the data from the target volume.

Hitachi Compatible Software for IBM® FlashCopy® SE (HCFSE) is functionally similar to the standard Hitachi Compatible FlashCopy®. The difference is that HCFSE uses space efficient volumes for the copy targets. With a space efficient volume, space is not allocated when it is created. Space gets allocated only when data is written to the volume. This allows the Compatible FlashCopy® V2 target volume capacity to be thinly provisioned (smaller than the full capacity of the source volume). Therefore, when you plan for Hitachi Compatible FlashCopy® you can provision less disk capacity when using HCFSE than when using standard Hitachi Compatible FlashCopy®. This can help lower the amount of physical storage that is needed by many installations.

The following Compatible FlashCopy® V2 operations are performed using Device Manager - Storage Navigator. All other operations are performed using the mainframe host interface.

- Enabling the following features:
  - Hitachi Compatible Mirroring for IBM® FlashCopy® V2
  - Hitachi Compatible Software for IBM® FlashCopy® SE
- Setting the FC Slower Copy options.
- Changing the state change pending (SCP) time for control units (CUs).
- Viewing Compatible FlashCopy® V2 established relationships and relationship history.

Relationship history can only be displayed using Device Manager - Storage Navigator. Business Continuity Manager (BCM), other host commands, and HDvM - SN can be used to monitor Compatible FlashCopy® V2. BCM can only be used to monitor established relationships. It cannot control Compatible FlashCopy® V2 operations.

# Compatibility between Compatible FlashCopy® and mainframe host interfaces

The following table shows the compatibility between Compatible FlashCopy® functions and mainframe host interface functions, including TSO, DFSMSdss, ICKDSF, and ANTRQST macro.

**Table 1 Compatibility between Compatible FlashCopy and mainframe host interfaces**

Functions		Host interface			
		TSO	DFSMSdss	ICKDSF	ANTRQST macro
Volume copy	Multi relationship	Yes	Yes	Yes	Yes
	NOCOPY mode	Yes	Yes	Yes	Yes
	COPY mode	Yes	Yes	Yes	Yes
Dataset copy <sup>1</sup>	Multi relationship	Yes	Yes	No	Yes
	NOCOPY mode	Yes	Yes	No	Yes
	COPY mode	Yes	Yes	No	Yes
COPY mode <sup>1</sup>	Multi relationship	Yes	Yes	Yes	Yes
	Change to NOCOPY mode	No	No	No	No
NOCOPY mode	Multi relationship	Yes	Yes	Yes	Yes
	Change to COPY mode	Yes	Yes	Yes	Yes
Incremental FlashCopy® <sup>1</sup>	Multi relationship	No	No	No	No
	NOCOPY mode	No	No	Yes	No
	COPY mode	Yes	Yes	Yes	Yes
Using consistency groups for dataset copies	Multi relationship	Yes	Yes	No	Yes
	NOCOPY mode	Yes	Yes	No	Yes
	COPY mode	Yes	Yes	No	Yes
Reverse Restore <sup>1</sup>	Multi relationship	No	No	No	No
	NOCOPY mode	No	No	No	No
	COPY mode	Yes	Yes	Yes	Yes
FlashCopy® to PPRC Primary Volume <sup>1</sup>	Multi relationship	Yes	Yes	Yes	Yes
	NOCOPY mode	Yes	Yes	Yes	Yes
	COPY mode	Yes	Yes	Yes	Yes
FlashCopy® to URz Primary Volume <sup>1</sup>	Multi relationship	Yes	Yes	Yes	Yes
	NOCOPY mode	Yes	Yes	Yes	Yes
	COPY mode	Yes	Yes	Yes	Yes
Fast Reverse Restore	Multi relationship	No	No	No	No
	NOCOPY mode	Yes	No	Yes	Yes
	COPY mode	Yes	No	Yes	Yes

Functions		Host interface			
		TSO	DFSMSdss	ICKDSF	ANTRQST macro
Remote FlashCopy®	Multi relationship	No	No	No	No
	NOCOPY mode	Yes	No	Yes	Yes
	COPY mode	Yes	No	Yes	Yes
Preserve Mirror FlashCopy® <sup>1</sup>	Multi relationship	Yes	Yes	Yes	Yes
	NOCOPY mode	Yes	Yes	Yes	Yes
	COPY mode	Yes	Yes	Yes	Yes
<b>1.</b> Not supported in FCSE					

## Overview of Compatible FlashCopy® relationships

- [About Compatible FlashCopy V2 relationships on page 19](#)
- [About Compatible FlashCopy SE relationships on page 21](#)
- [Copy modes on page 21](#)
- [Copying by volume on page 26](#)
- [Copying by dataset \(Compatible FlashCopy V2 only\) on page 26](#)

## About Compatible FlashCopy® V2 relationships

Compatible FlashCopy® V2 provides fast data replication that enables you to virtually or physically copy the source data to a target volume. To establish a Compatible FlashCopy® V2 relationship, you must specify the source volume and target volume. This constitutes a copy pair, or a relationship. After you have created a relationship, hosts can access data that is copied to the target volume.

When you establish a Compatible FlashCopy® V2 relationship, you can specify a range of data to be copied, called an *extent*. You can also make multiple copies of data from one copy source. When you specify a portion of a volume (an extent) as the copy source, the capacity of the source volume (S-VOL) and the target volume (T-VOL) can be different. However, the minimum size of the specified target volume or extent must be equal to that of the source volume or extent. When you specify an extent, both the copy source and the copy target can reside within the same volume.

To copy a dataset, specify the copy range as an extent. The smallest extent is a *track*. With Compatible FlashCopy® V2, a dataset is an extent for which addresses are determined by the dataset entries in the VTOC.

Compatible FlashCopy® V2 allows you to establish up to 16 relationships from one extent, as shown in the following figure. You cannot create a cascaded relationship. That is, you cannot use an extent that is a copy target as a copy source to create a new relationship.

In the VSP G1000 and G1500, and VSP F1500 storage system, information about Compatible FlashCopy® V2 relationships is stored in control areas on the data drives and loaded into memory to enable high-speed data access. However, when the memory is cleared (for example during system installation, or power-on after a scheduled outage, or power failure), establishing relationships might take longer than after the storage system has been in normal operation.

Multiple relationships can be established from a single source extent.

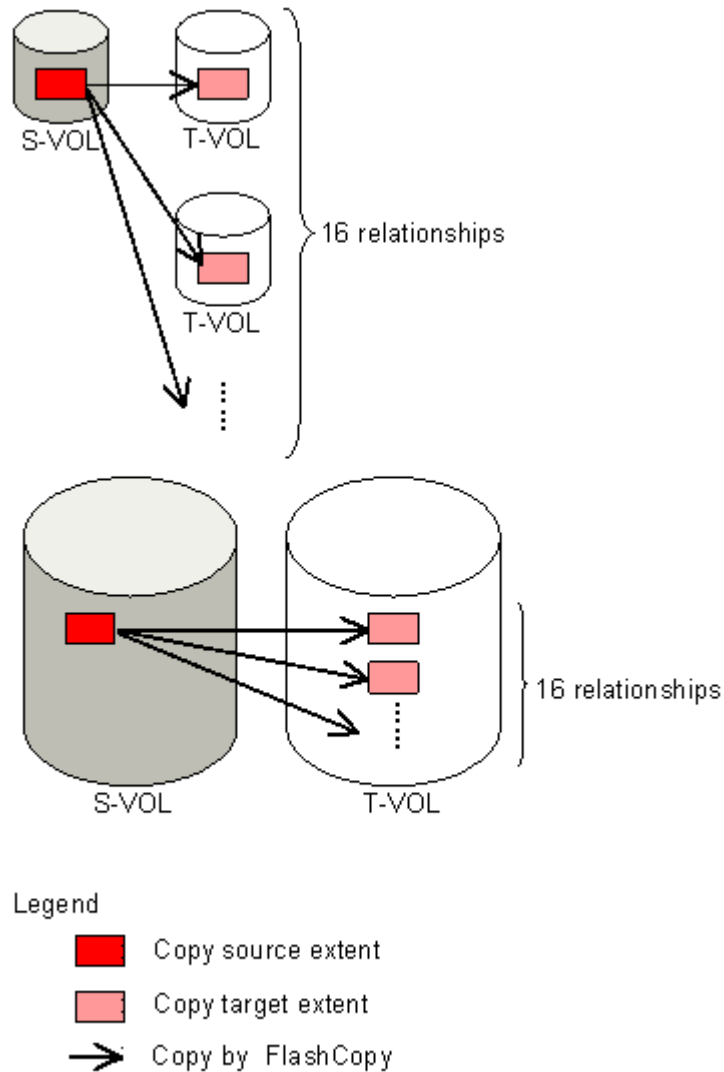

**Figure 1 Example of multiple relationships**

Cascaded relationships are not supported from a single source extent.

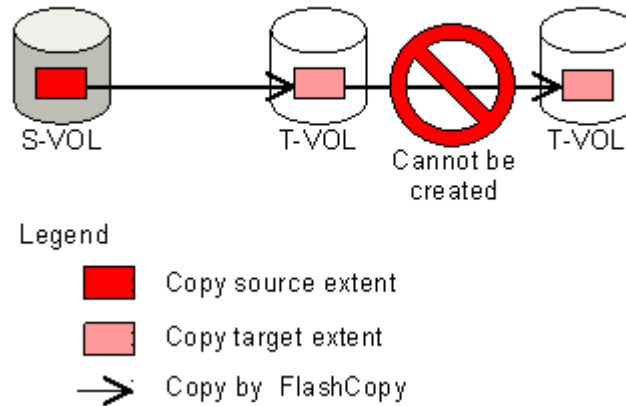

**Figure 2 Cascading relationships from a single source extent**

## About Compatible FlashCopy® SE relationships

HCFCSE provides a fast data replication capability that enables you to access the source data on a "space-efficient" target volume. The target volume is a thinly provisioned volume (TSE-VOL) that can be smaller in size/capacity than the source volume.

An important difference between HCFCSE and Compatible FlashCopy® V2 is the use of space efficiency. When a HCFCSE relationship is created, disk space on the target volume is used only when a write operation to the source volume needs to be updated on disk or when a write operation is directed to the target volume.

For the duration of a HCFCSE relationship, when a source volume has little or no write activity, the target volume will use considerably less physical storage space than the source volume. However, when a source volume has a high level of write activity, there will be little space saved when compared with Compatible FlashCopy® V2. Therefore, HCFCSE volume relationships should be established only for source volumes that will have minimal write activity.

Background copy is not allowed on HCFCSE relationships.

HCFCSE relationships might fail when no space is available in the storage pools allocated for the target volumes.

For details about HCFCSE operations when the Dynamic Provisioning pools are filling or become full, see [Pool operations and TSE-VOLS on page 141](#).

## Copy modes

When you establish a Compatible FlashCopy® V2 relationship, select one of the following modes for the copy operation: COPY or NOCOPY.

- COPY (Compatible FlashCopy® V2 only): When you select COPY mode, all data in the S-VOL is copied to the T-VOL. This process is called *background*

*copying*. When the background copy operation is complete, the relationship is withdrawn automatically.

COPY mode is not supported for HCFCSE.

- **NOCOPY:** When you select NOCOPY mode, the background copying operation is not performed. However, the background copying operation is performed in the following cases:
  - For the applicable relationship, when you execute the **Establish** command with NOCOPY2COPY specified.
  - While deleting the applicable relationship, when you execute the **Withdraw** command with DDSW(YES) specified.
  - When you delete a data set, or a host issues the **Withdraw** command with DDSW(YES) specified.

There are two main differences between how data is copied with Hitachi Compatible Mirroring for IBM® FlashCopy® V2 and HCFCSE. First, Hitachi Compatible Mirroring for IBM® FlashCopy® V2 can perform a background copy if the COPY option is specified. Background copy is not allowed with HCFCSE, so only the NOCOPY option can be specified. Second, Hitachi Compatible Mirroring for IBM® FlashCopy® V2 can create copies of entire volumes or specified datasets, but HCFCSE only allows copies of entire volumes.

## On-demand copy

When a write operation is requested to an area of the source volume that Compatible FlashCopy® V2 has not yet copied to the target volume, a copy of the point-in-time (pre-update) data is first written to the target volume. Then, the update is written to the source volume. This process is called *on-demand copy*. On-demand copy works in both COPY mode and NOCOPY mode.



**Caution:** When you select NOCOPY mode, even if all data in the S-VOL is copied to the T-VOL through on-demand copy, Compatible FlashCopy® V2 does not automatically withdraw the relationship. Therefore, when you select NOCOPY mode, you must withdraw the relationship explicitly using the **FCWITHDR** command.

If you select the NOCOPY2COPY mode (Compatible FlashCopy® V2 only) for a relationship created using NOCOPY mode, the background copy operation is performed. When all data is copied, the relationship is automatically released.

---

## Write request to an area of the source volume not yet copied to the target

When a write operation is requested to an area of the source volume that Compatible FlashCopy® V2 has not yet copied to the target volume, old data is copied to the target volume by the Copy After Write (CAW) method or the Copy On Write (COW) method.

The following figures show both the CAW method and the COW method.

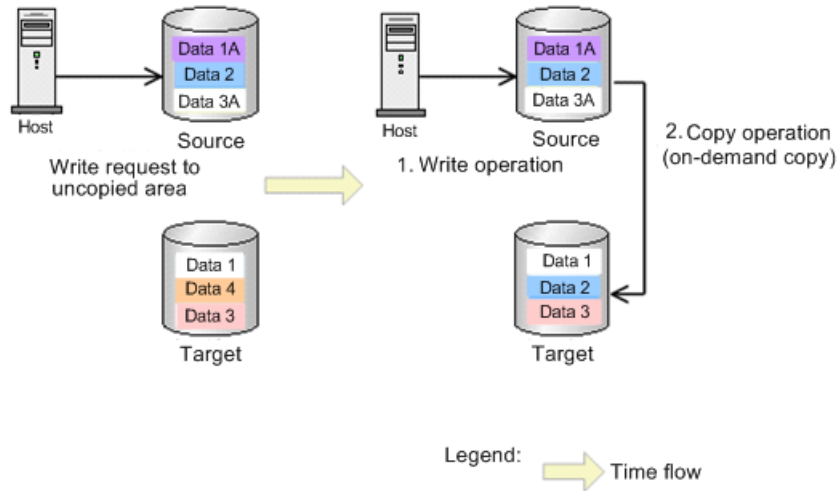

**Figure 3 On-demand copy by the CAW method when there is a write request to an area not yet copied**

1. There is a write request for the data that has not been copied from the host to a T-VOL.
2. A write operation is executed before on-demand copy.
3. A copy operation is executed asynchronously from the source volume to a target volume (on-demand copy) after the write process.

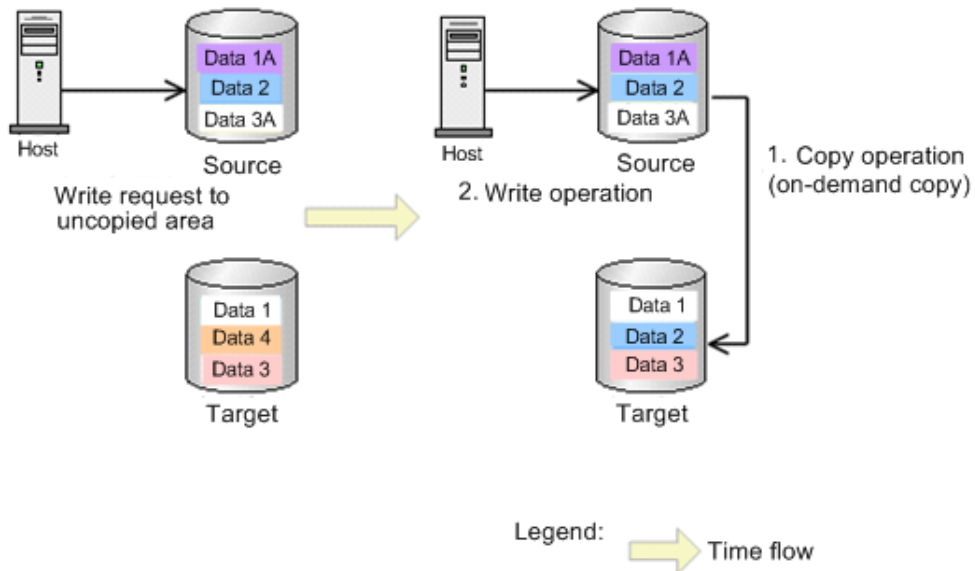

**Figure 4 On-demand copy by the COW method when there is a write request to an area not yet copied**

1. There is a write request for the data that has not been copied from the host to a T-VOL.
2. On-demand copy is executed before the write operation. Then, data that has not been copied is copied from the source volume to the target volume.

3. After the data has been copied by on-demand copy, the write operation is executed.

In the CAW method, the write operation is executed before on-demand copy. Therefore, the host wait time for the write operation is shorter than the COW method. To operate on-demand copy using the CAW method, set system option mode 1061 to on. System option mode 1061 is off by default. When system option mode 1061 is set to off, on-demand copy uses the COW method. Depending on the storage system's situation (for example, if the load is high), even if system option mode 1061 is set to on, on-demand copy might still use the COW method.

### **Cases when on-demand copy does not operate by the CAW method**

When there is a read request or write request to an area of the target volume that has not yet been copied, on-demand copy does not use the CAW method in the following cases:

- Write pending rate is 60% or more when writing in random access mode, or 30% or more when writing in sequential access mode.
- Writing to an area in which the Cache Residency Manager's Bind mode is set. (If writing to an area in which the priority mode is set, on-demand copy uses the CAW method).
- Cache access mode is cache fast write (CFW).
- Writing to an external volume when the cache mode is disabled. When writing to an external volume using the **Format Write** command, on-demand copy uses the CAW method.
- Writing to an area in which the Dynamic Provisioning for Mainframe volume's page is not assigned.
- The source volume is a TSE-VOL.

### **Read or write request to an area of the target volume not yet copied**

When a read or write operation is requested to an area of the target volume that has not yet been copied, old data in the source volume is copied to the target volume first. The following figures show the process flow.

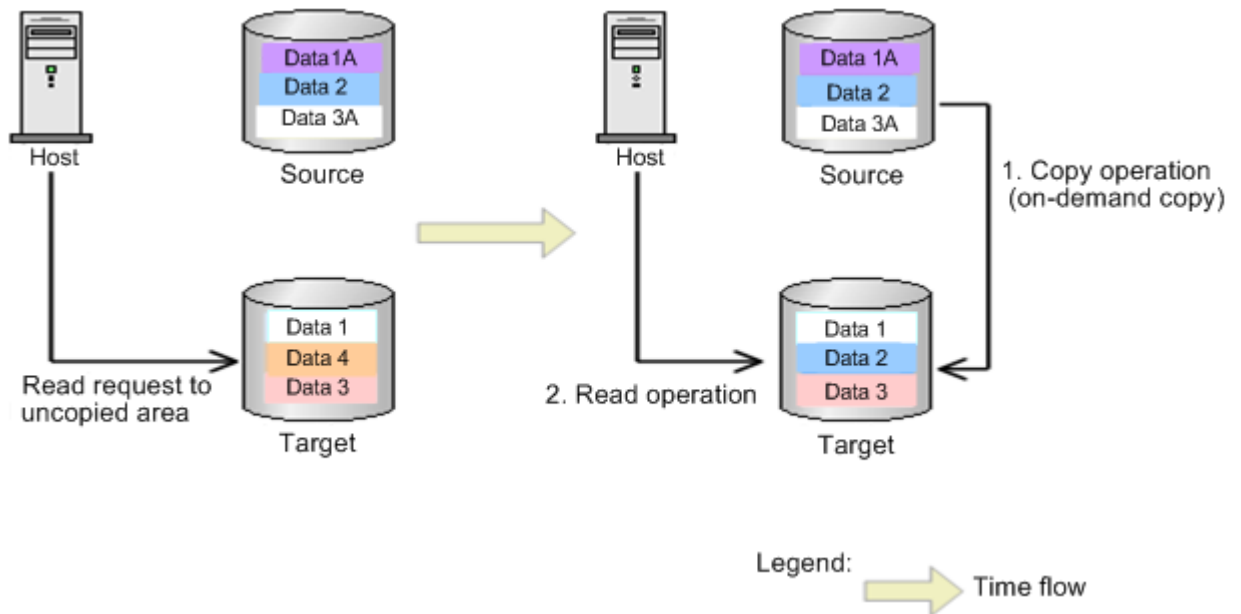

**Figure 5 On-demand copy when there is a read request to an area of the target volume not yet copied**

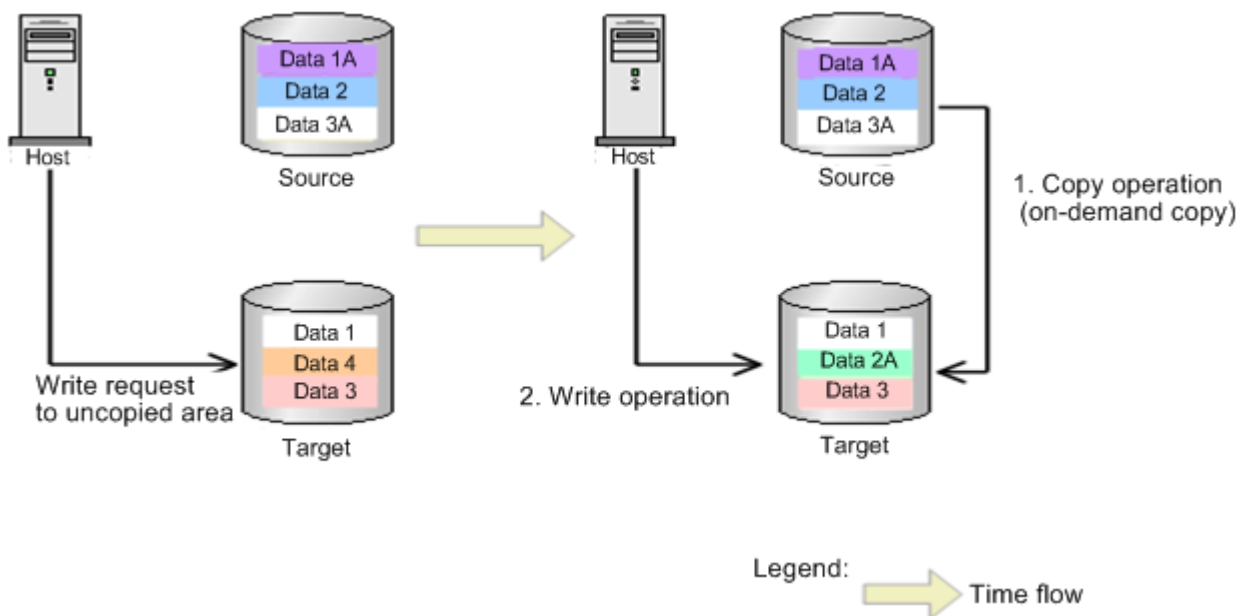

**Figure 6 On-demand copy when there is a write request to an area of the target volume not yet copied**

1. There is a read request or write request to the area in the S-VOL or T-VOL where the data has not been copied.
2. When a read or write is made to the area in the S-VOL or T-VOL where the data has not been copied, Compatible FlashCopy® V2 performs on-demand copying. The data is copied from the S-VOL to the T-VOL.
3. When on-demand copying is complete, Compatible FlashCopy® V2 performs the read or write operation.

On-demand copying might not always be executed when there is a read request to the area in the S-VOL or T-VOL. In this case, the host reads the source volume, not the target volume.

## Copying by volume

If you do not specify an extent when you establish a relationship, the entire volume is copied. This is called *volume copying*. To perform volume copying, the capacity of the copy target volume must be equal to or larger than the capacity of the copy source volume.

When you establish a HCFCSE relationship, only a "FULL Volume" relationship with NOCOPY mode is supported.

## Copying by dataset (Compatible FlashCopy® V2 only)

If you specify the extent when you establish a relationship, only a portion of the volume is copied. This is called *dataset copying*. Dataset copying establishes the relationship using the specified extent or extents. You can specify up to 16 target extents for one source extent. To perform dataset copying, the copy source extent must have the same number of tracks as the copy target extent.

### Dataset copying can be performed when:

- The position of the copy source extent is different from the position of the copy target extent, and both extents are on the same volume.
- The copy source extent and the copy target extent are on different volumes.
- The copy source extent and the copy target extent do not overlap when they are on the same volume.
- The data in a single source extent will be copied simultaneously to multiple target extents.
- Volume copying is being performed using the same source volume.
- The number of overlapping extents in each overlapped area must be 16 or less.

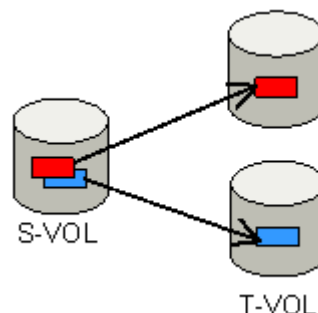

**Figure 7** Overlap of copy source extents

**Dataset copying cannot be performed when:**

- One of the copy target extents overlaps another copy target extent.
- One of the copy target extents overlaps a copy source extent.
- Establishing with an overlapping copy source extent and target extent for a copy target extent that already has a relationship.

## Using consistency groups for dataset copies that span volumes

Compatible FlashCopy® is often used to make copies of data that crosses the volume boundary. In these cases, the data that crosses the volume boundary needs to be consistent, that is, it must be copied in the proper order. Consistency groups provide a way to achieve a consistent data copy across multiple volumes without requiring that application I/O be quiesced.

The following figures show examples of using consistency groups:

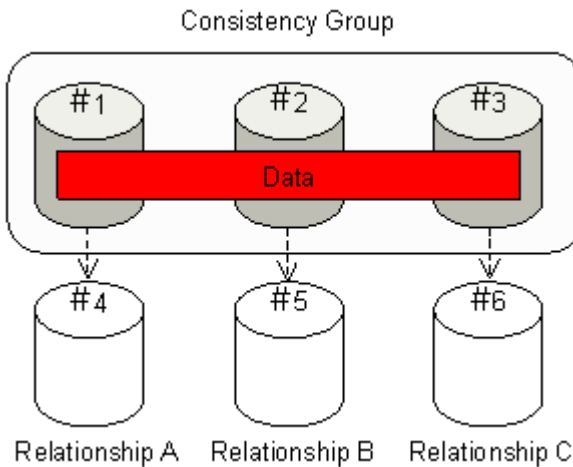

**Figure 8 Copying data stored on multiple volumes**

The figure shows copying the data stored on volumes #1-#3 to volumes #4-#6. You need to establish relationships for volume #1 and #4, #2 and #5, and #3 and #6, then copy the data. However, if volume #1 is updated before the creation of the Relationship B (relationship of #2 and #5) is completed, the consistency of the data in the copy target cannot be maintained.

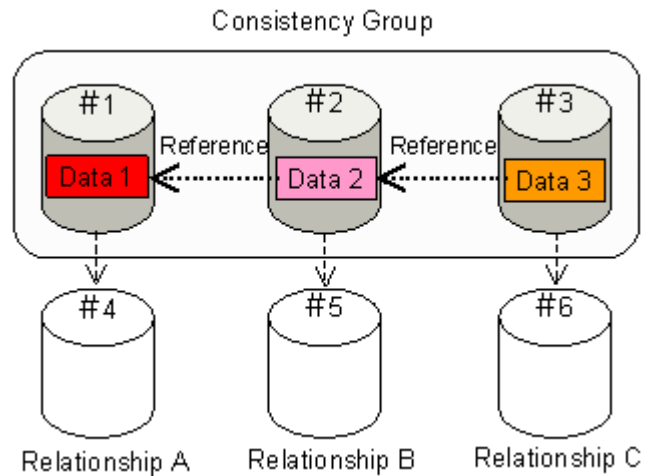

**Figure 9 Copying data with references that cross volume boundaries**

The figure shows Data 2 in Volume #2 reference Data 1 in volume #1, and Data 3 in volume #3 references Data 2 in volume #2. Without consistency groups, when you try to copy Data 1 - 3 to volume #4 - #6, if Data 1 is updated before the copy operation of Data 2 is complete, the data consistency of copied Data 1 and copied Data 2 will not be maintained.

Consistency groups maintain data consistency across volumes when they are copied using Compatible FlashCopy®. In the figure, Compatible FlashCopy® regards volumes #1 - #3 as a single consistency group, and suspends write operations from the host to the source volumes until the three relationships (Relationship A, Relationship B, and Relationship C) are created and all copy processing is finished. To suspend write operations to source volumes, you issue the command that creates the relationships with the appropriate "freeze" option set for your interface.

When Compatible FlashCopy® and TrueCopy for Mainframe (TCz) share volumes, the results of operations such as creating pairs and relationships will differ depending on whether you are using a consistency group.

## Incremental FlashCopy® (Compatible FlashCopy® V2 only)

The Incremental FlashCopy® function maintains a relationship even after the copy operation from copy source to target is completed. After the background copy completes, when the S-VOL or T-VOL is updated, the location of the updated data is managed using differential bitmaps. If the command to establish a relationship is re-executed on the volumes originally related using the Incremental FlashCopy® function, only differential data is copied. The Incremental FlashCopy® workflow is shown in the following figure.

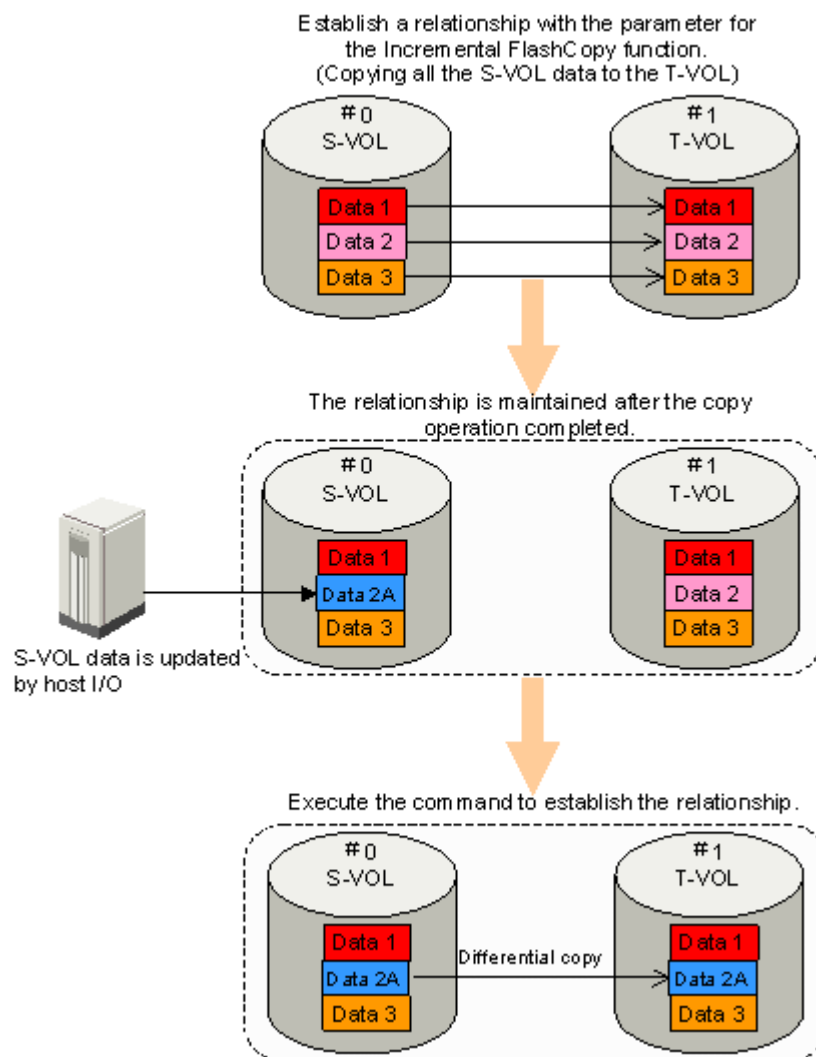

**Figure 10 Incremental FlashCopy®**

The previous figure shows Data 2A managed as differential data. If you re-execute the command to establish the relationship, only the differential data of Data 2A is copied to the T-VOL.

You cannot perform the Restore function when:

- The original relationship was established without using the Incremental FlashCopy® function.
- The original relationship was re-established by the Fast Reverse Restore function, and then the relationship was re-established by the Restore function twice more.

For information about the Fast Reverse Restore function, see [Fast Reverse Restore on page 31](#).

## Reverse Restore (Compatible FlashCopy® V2 only)

The Reverse Restore function enables you to simplify data recovery. This function reverses the original S-VOL and T-VOL relationship established by the Incremental FlashCopy® function. This reversal re-establishes the relationship with the data flowing in the opposite direction.

You cannot perform the Reverse Restore function in the following cases:

- The original relationship was established without using the Incremental FlashCopy® function.
- A copy operation established in COPY mode is not yet completed.
- The original relationship was established in NOCOPY mode.
- The relationship being reversed includes a relationship established with multiple volumes.
- The T-VOL capacity exceeds the S-VOL capacity in the relationship being reversed.
- The original relationship was re-established using the Fast Reverse Restore function.

For information about the Fast Reverse Restore function, see [Fast Reverse Restore on page 31](#).

To determine whether the Reverse Restore function can be used, examine the results of the `FLASHCOPY QUERY RELATIONS` command of ICKDSF. For more information, see [Displaying information about Compatible FlashCopy V2 relationships: FLASHCPY QUERY RELATIONS on page 107](#).

When you perform the Reverse Restore function, only updated data is copied from the new source volume (former target volume) to the new target volume. This is just the reverse of what happens when a standard Incremental FlashCopy® is established.



**Note:** Data written to the former source volume, but not yet copied to the former target, will be lost once the Reverse Restore relationship is executed.

---

The Incremental FlashCopy® workflow of Reverse Restore is shown in the following figure.

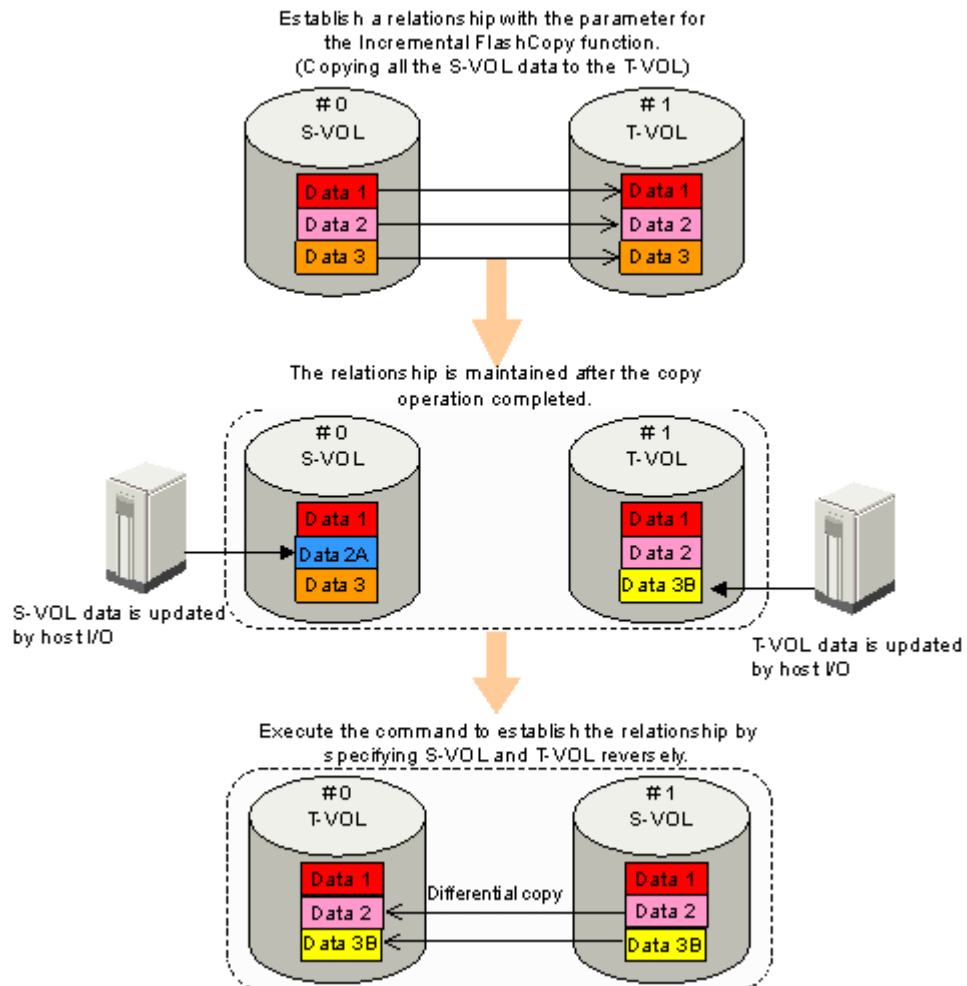

**Figure 11 Reverse Restore**

## Fast Reverse Restore

The Fast Reverse Restore function, available for both Compatible FlashCopy® V2 and HCFCSE, enables you to simplify data recovery. This function reverses the original S-VOL and T-VOL relationship established by Compatible FlashCopy® V2. This reversal re-establishes the relationship with the data flowing in the opposite direction. The Fast Reverse Restore function is available for HCFCSE only if the Incremental FlashCopy® function is not in use.

You cannot perform the Fast Reverse Restore function in the following cases:

- The relationships to be reversed include a relationship established with multiple volumes.
- The T-VOL capacity exceeds the S-VOL capacity in the relationship to be reversed.

- The original relationship was re-established using the Fast Reverse Restore function.
- The original relationship was established using HCFCSE, and the Incremental FlashCopy® function is in use. A relationship established using Incremental FlashCopy® cannot be created using HCFCSE, so this describes the existence of multiple relationships.

You can perform the Fast Reverse Restore function on a relationship established in NOCOPY mode or during the copy process. If you perform the Fast Reverse Restore function during the copy process, the copy process will terminate.

After you re-establish a relationship by using the Fast Reverse Restore function, the contents of the new S-VOL are not ensured, as they will be changed by any host write operations.

When you perform the Fast Reverse Restore function, only the updated data is copied from the newly specified S-VOL (former T-VOL) to the T-VOL (former S-VOL) as with ordinary relationship re-establishment. The updated Data 2A in the target volume is then lost (as shown in the following figure).

The Incremental FlashCopy® workflow of Fast Reverse Restore is shown in the following figure.

Establish a relationship in NOCOPY mode with the parameter for the FlashCopy relationship function.

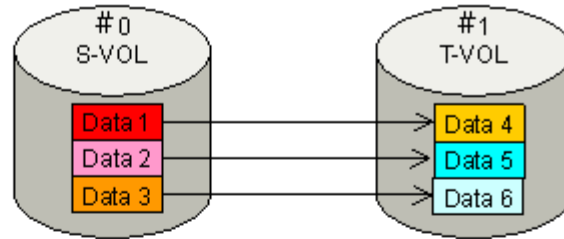

On-demand Copy is not performed until writing request to the non-copied area of the S-VOL or reading/writing request to the non-copied area of the T-VOL occurs because the relationship was established in NOCOPY mode.

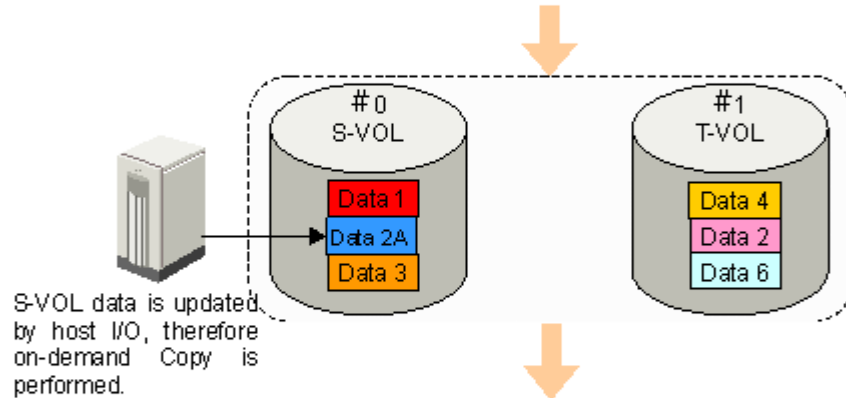

Execute the command with specifying S-VOL and T-VOL reversely and with specifying Fast Reverse Restore option.

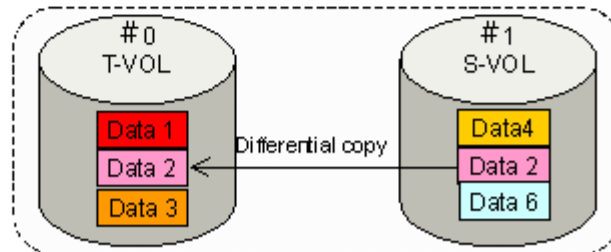

Contents of new S-VOL data is not ensured.

**Figure 12 Fast Reverse Restore**

## FlashCopy® to PPRC Primary Volume (Compatible FlashCopy® V2 only)

The FlashCopy® to PPRC Primary Volume function (Peer-to-Peer Remote Copy) enables you to share Compatible FlashCopy® V2 T-VOLs and TCz P-VOLs. When you share Compatible FlashCopy® V2 T-VOLs and TCz P-VOLs, the status of the TCz pairs must be Duplex, Pending, or Suspend. You can

create TCz pairs after creating Compatible FlashCopy® V2 relationships, or create Compatible FlashCopy® V2 relationships after creating TCz pairs.

You can create Compatible FlashCopy® V2 relationships after creating TCz pairs only when the specified options are used in the following host interfaces:

- DFSMSdss: FCTOPPRCPRIMARY
- TSO: TGTPPRIM (YES)
- ICKDSF: TGTOKASPPRCPRIM (YES)
- ANTRQST macro: TGTPPRIM (YES)

For information about using Compatible FlashCopy® V2 with TCz, see [Using Compatible FlashCopy with TrueCopy for Mainframe on page 53](#).

The requirements of the FlashCopy® to PPRC Primary Volume function follow:

- TCz is a prerequisite for using the FlashCopy® to PPRC Primary Volume function.
- The FlashCopy® to PPRC Primary Volume function cannot be used for TCz pairs that are registered in consistency groups.
- Data that Compatible FlashCopy® V2 copies to TCz P-VOLs is transferred to TCz S-VOLs asynchronously. TCz displays the progress of the asynchronous data transfer. Depending on the timing of the Compatible FlashCopy® V2 and TCz copy operations, a time delay might occur and the TCz asynchronous data transfer might progress slowly.
- If the Compatible FlashCopy® V2 S-VOL and T-VOL are Dynamic Provisioning for Mainframe volumes, the number of pages remaining in the T-VOL might differ, depending on the timing.
- If you create TCz pairs or resynchronize suspended pairs when Compatible FlashCopy® V2 relationships exist, Compatible FlashCopy® V2 prepares as many copies as the number of relationships. The higher the number of relationships per volume, the longer it takes for TCz pairs to become Duplex. Even with less load, it takes approximately 1.5 times longer when the TCz pairs are not used with Compatible FlashCopy® V2.

When using the FlashCopy® to PPRC Primary Volume function, the maximum number of relationships (or datasets) per volume should be 2,000. If that is not possible, establish one relationship for each volume. This causes non-data-set parts to be copied as well, but the status of the TCz pairs will change to Duplex in a shorter time.

## **Copy operation between FlashCopy® relationships and TCz pairs (Compatible FlashCopy® V2 only)**

The following figures show the copy operation of Compatible FlashCopy® V2 relationships and TCz pairs by the FlashCopy® to PPRC Primary Volume function.

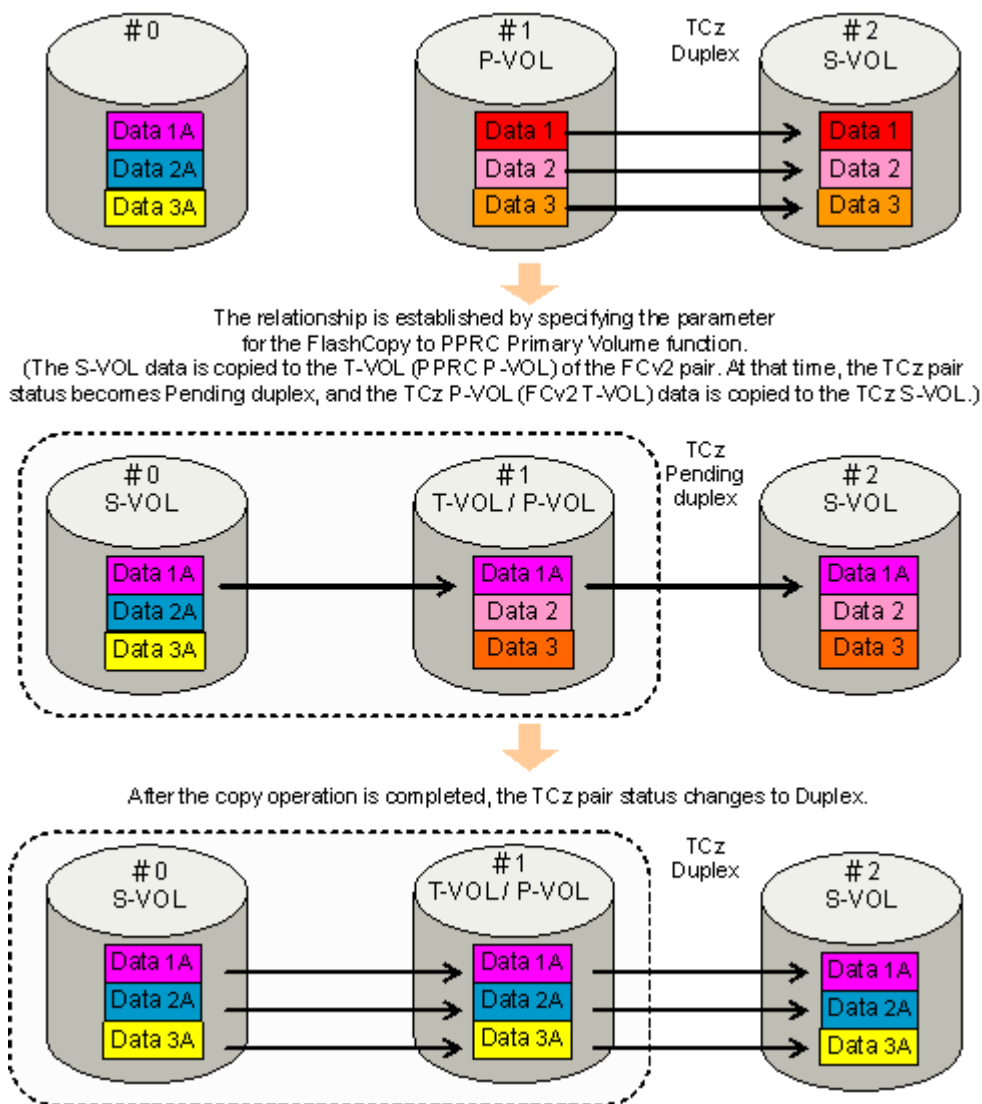

**Figure 13 Creating a Compatible FlashCopy® V2 relationship in a TCz pair**

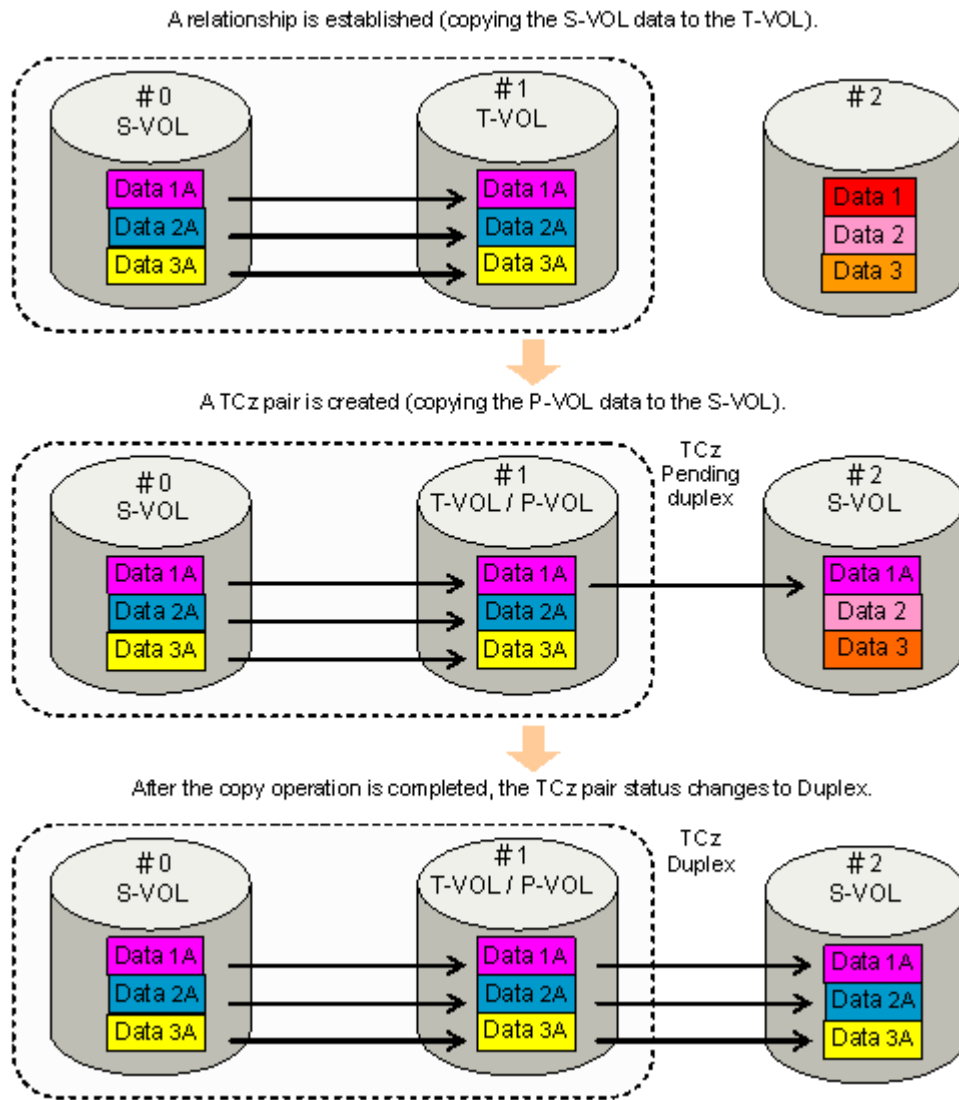

**Figure 14 Creating TCz pair in Compatible FlashCopy® V2 relationship**

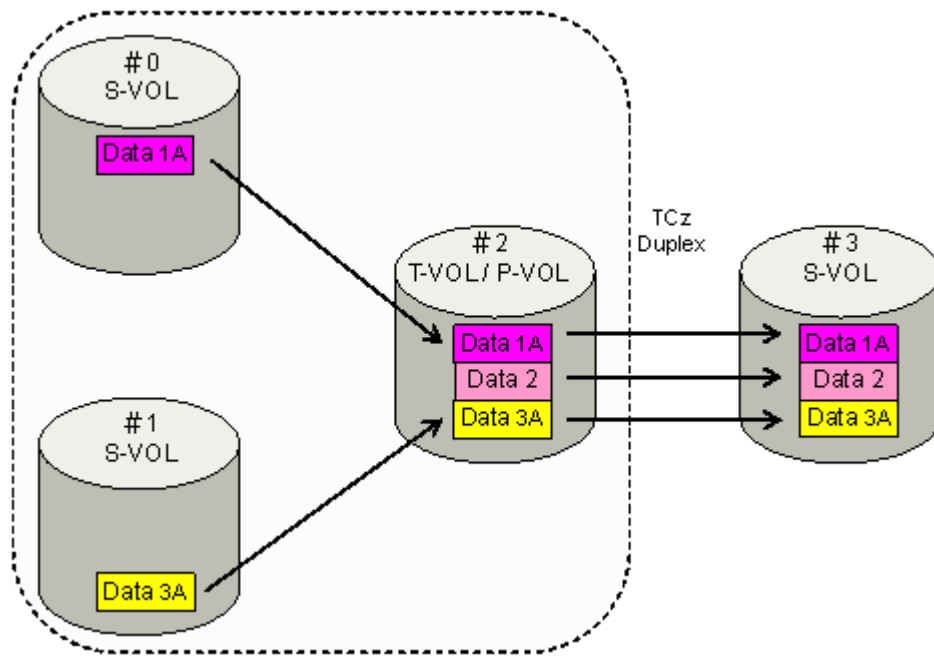

**Figure 15 Copying TCz pairs when Compatible FlashCopy® V2 datasets reside on separate volumes**

## Remote FlashCopy®

The Remote FlashCopy® function enables you to perform operations on Compatible FlashCopy® relationships on the TCz secondary storage system. These operations are performed from the host connected to the TCz primary storage system. This function can be used for both Compatible FlashCopy® V2 and HCFCSE relationships.

The Remote FlashCopy® function operates as follows:

- 1.** A Compatible FlashCopy® operation command is issued to the TCz P-VOL.
- 2.** The command is transmitted from the Main Control Unit (MCU) to the Remote Control Unit (RCU).
- 3.** The secondary storage system identifies the TCz S-VOL as a Compatible FlashCopy® S-VOL, and then performs a Remote FlashCopy® operation (for example, it creates a relationship, releases a relationship, or displays information about a relationship).

You cannot perform the Remote FlashCopy® function in the following cases:

- The Compatible FlashCopy® operation command is not issued to the TCz P-VOL.
- The Compatible FlashCopy® source volume is not the TCz secondary volume.

- You specify an extent when you establish a relationship. You cannot use extents to establish a relationship for dataset copying.
- The TCz S-VOL status is Simplex (unpaired).
- The TCz S-VOL status is Pending.
- The TCz S-VOL status is Duplex or Suspend, and the TCz P-VOL status is Simplex or Pending.

The following figure shows the Remote FlashCopy® function. If the HCFCSE license is not installed on the primary storage system, only the HCFCSE relationships on the secondary storage system are released.

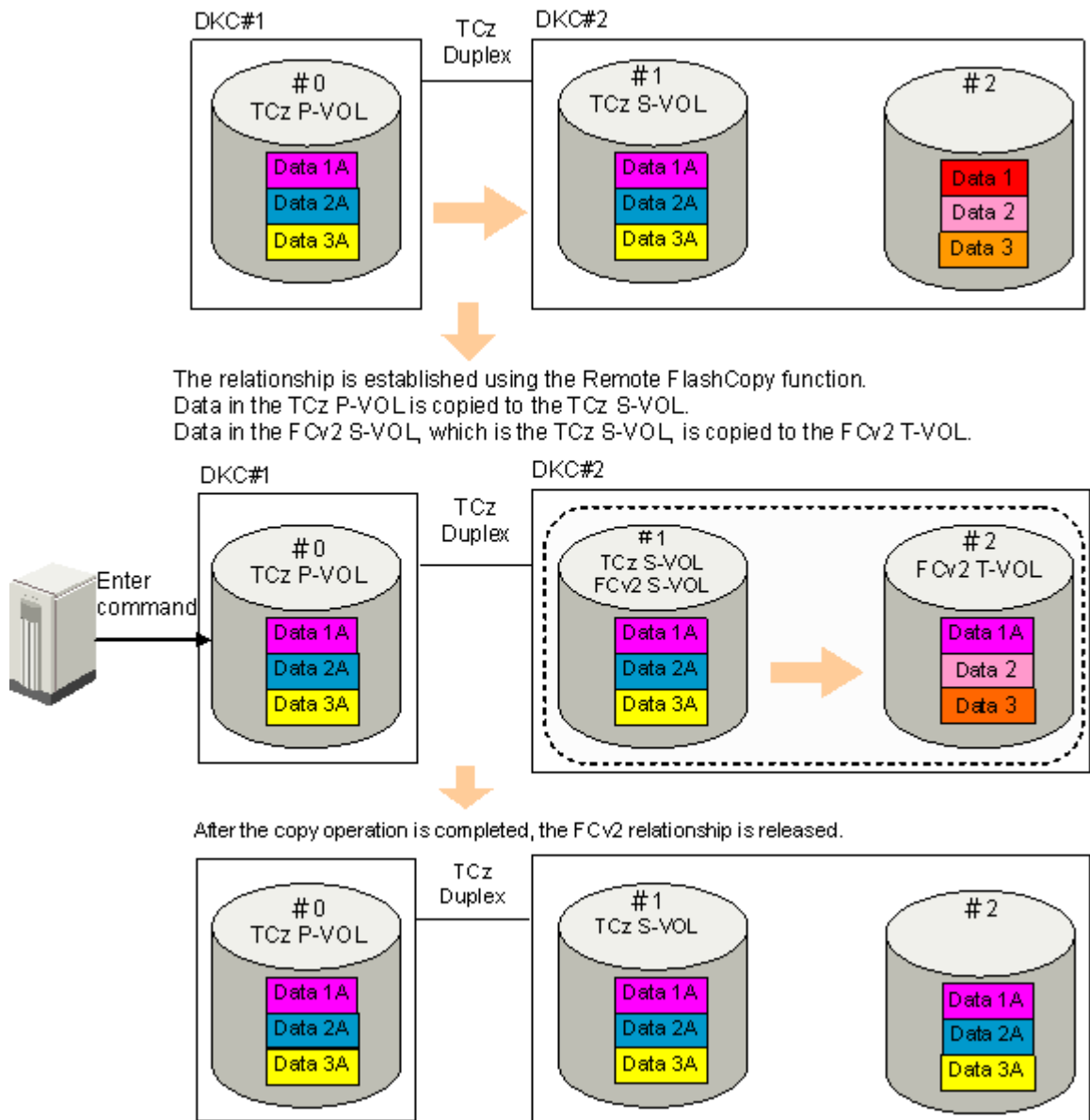

**Figure 16 Remote FlashCopy®**

## Combining Remote FlashCopy® functions with other Compatible FlashCopy® functions

**Table 2 Combining Remote FlashCopy functions with other Compatible FlashCopy functions**

Remote FlashCopy® function	Can be combined with other Compatible FlashCopy® functions?
Volume copy	Yes
Dataset copy*	No
COPY mode*	Yes
NOCOPY mode	Yes
Incremental FlashCopy®*	Yes
Using consistency groups for dataset copies	Yes
Reverse Restore*	No
FlashCopy® to PPRC Primary Volume*	Yes
Fast Reverse Restore	No
*Applies to Compatible FlashCopy® V2 only	

## FlashCopy® to URz Primary Volume (Compatible FlashCopy® V2 only)

The FlashCopy® to URz Primary Volume function enables you to share Compatible FlashCopy® V2 T-VOLs and URz P-VOLs. When you share Compatible FlashCopy® V2 T-VOLs and URz P-VOLs, the status of the URz pairs must be Duplex, Pending, Suspend, or Suspending. You can create URz pairs after creating Compatible FlashCopy® V2 relationships. You can also create Compatible FlashCopy® V2 relationships after creating URz pairs but only when the specified options are used in the following host interfaces:

- DFSMSdss: FCTOPPRCPRIMARY
- TSO: TGTPPRIM (YES)
- ICKDSF: TGTOKASPPRCPRIM (YES)
- ANTRQST macro: TGTPPRIM (YES)

For information about using Compatible FlashCopy® V2 with URz, see [Using Compatible FlashCopy with Universal Replicator for Mainframe on page 61](#).

The requirements of the FlashCopy® to URz Primary Volume function are as follows:

- Universal Replicator for Mainframe is a prerequisite for using the FlashCopy® to URz Primary Volume function.
- The FlashCopy® to URz Primary Volume function can be used regardless of the status of URz.

- The FlashCopy® to URz Primary Volume function cannot be used for the URz configuration combined with the multiple primary system and secondary system using CCI.
- The FlashCopy® to URz Primary Volume function cannot be used for URz in 3DC multi-target configuration using 3 URz sites.
- Data that Compatible FlashCopy® V2 copies to URz P-VOLs is transferred asynchronously to URz S-VOLs. URz displays the progress of this asynchronous data transfer. Depending on the timing of the Compatible FlashCopy® V2 and URz copy operations, a time delay might occur between the Compatible FlashCopy® V2 copy operation and the URz copy operation, and the URz asynchronous data transfer might progress slowly.
- If the Compatible FlashCopy® V2 S-VOL and T-VOL are Dynamic Provisioning for Mainframe volumes, the number of pages remaining in T-VOL may differ depending on the timing.
- If you create URz pairs or resynchronize suspended pairs when Compatible FlashCopy® V2 relationships exist, Compatible FlashCopy® V2 prepares as many copies as the number of relationships. The larger the number of relationships per volume, the longer it takes for URz pairs to become Duplex. Even with less load, it takes approximately 1.5 times longer when the URz pairs are not used with Compatible FlashCopy®. When using the Preserve Mirror FlashCopy® function, the maximum number of relationships (or datasets) per volume should be 2,000 or less. If that is not possible, you should create and operate one relationship for each volume. This causes non-data-set parts to be copied as well, but the status of the TCz pairs will change to Duplex in a shorter time.

The copy process of Compatible FlashCopy® V2 relationships and URz pairs by the FlashCopy® to URz Primary Volume function is the same as that of the FlashCopy® to PPRC Primary Volume function.

## **Preserve Mirror FlashCopy® (Compatible FlashCopy® V2 only)**

If a Compatible FlashCopy® V2 T-VOL is a TCz P-VOL, the FlashCopy® to PPRC Primary Volume function copies data from the Compatible FlashCopy® V2 T-VOL to the TCz S-VOL. During the data copy, the status of the TCz pair is Pending. If a failure occurs, the consistency of the data on the TCz S-VOL cannot be guaranteed. The Preserve Mirror FlashCopy® function enables you to copy the Compatible FlashCopy® V2 data to the secondary system with the status of the TCz pairs as Duplex.

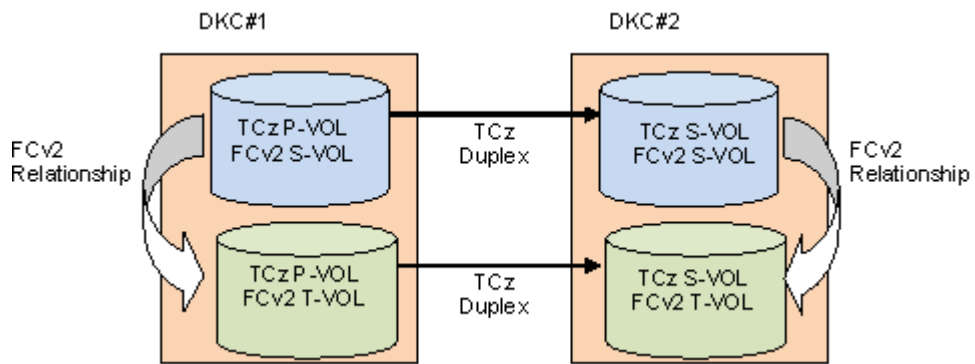

**Figure 17 Preserve Mirror FlashCopy® function**

The two options for establishing a Compatible FlashCopy® V2 relationship using the Preserve Mirror FlashCopy® function follow:

- **REQUIRED:** Perform the copy operation only when the Compatible FlashCopy® V2 relationship can be established using the Preserve Mirror FlashCopy® function. If the relationship cannot be established, the Preserve Mirror FlashCopy® command is rejected.
- **PREFERRED:** Perform the copy operation using the FlashCopy® to PPRC Primary Volume function, even if the Compatible FlashCopy® V2 relationship cannot be established using the Preserve Mirror FlashCopy® function. In this case, the status of the TCz pair changes to Pending.

When using the Preserve Mirror FlashCopy® function, note the following:

- TCz is required.
- Only TCz synchronous pairs can be used.
- The status of the two TCz pairs must be Duplex. If they are not, the outcome of the operation depends on the specified (`PRESMIRREQ` or `PRESMIRRPREF`) option.
- Best practice is to set the MIH timer to 45 seconds when working with TCz synchronous pairs.
- If you create TCz pairs or resynchronize suspended pairs when Compatible FlashCopy® V2 relationships exist, Compatible FlashCopy® V2 prepares as many copies as the number of relationships. The larger the number of relationships per volume, the longer it takes for TCz pairs to become Duplex. Even with less load, it takes approximately 1.5 times longer when the TCz pairs are not used with FlashCopy®.

When using the Preserve Mirror FlashCopy® function, the maximum number of relationships (or datasets) per volume should be 2,000 or less. If that is not possible, you should create and operate one relationship for each volume. This causes non-data-set parts to be copied as well, but the status of the TCz pairs will change to Duplex in a shorter time.

- When you establish a Compatible FlashCopy® V2 relationship with Preserve Mirror in COPY mode, a relationship might still be established in

both the MCU and RCU. The copy operations for the relationship in the MCU and the relationship in the RCU are not synchronized.

---

**Caution:** If you perform a Withdraw operation during the copy, both of the Compatible FlashCopy® V2 relationships are suspended. Data between P-VOL and S-VOL might not be consistent even though the status of the TCz pair is Duplex.

The status of a TCz volume can be determined by the `PPRC QUERY` command or through Device Manager - Storage Navigator by viewing the TCz Pair Operation window. To release this status, delete the TCz pair.

---

**Caution:** If the relationship at the primary site cannot be established, the relationship at the secondary site could be established, depending on the type of error. If you try again to create a Compatible FlashCopy® V2 relationship using the Preserve Mirror FlashCopy® function, but the relationship will not be established at the primary site, release the relationship at the secondary site, and then try again.

---

**Caution:** When using the Preserve Mirror FlashCopy® function, the missing interrupt handler (MIH) value should be the same as the value for TCz operations. The best practice is to specify 60 seconds for the MIH value for TCz and 30 seconds for the RIO MIH time used by TCz path monitoring. For information about the RIO MIH time, see the *Hitachi TrueCopy® for Mainframe User Guide*.

---

**Caution:** You cannot use the TCz zHyperWrite function when you use the Preserve Mirror FlashCopy® function. Do not operate the volume where DB2® log exists when you copy the data by using the Preserve Mirror FlashCopy® function. For information about the TCz zHyperWrite function, see the *Hitachi TrueCopy® for Mainframe User Guide*.

---

## Copy operation of Compatible FlashCopy® V2 relationships and TCz pairs (Compatible FlashCopy® V2 only)

The following figures show the copy operation of Compatible FlashCopy® V2 relationships and TCz pairs using the Preserve Mirror FlashCopy® function in COPY mode.

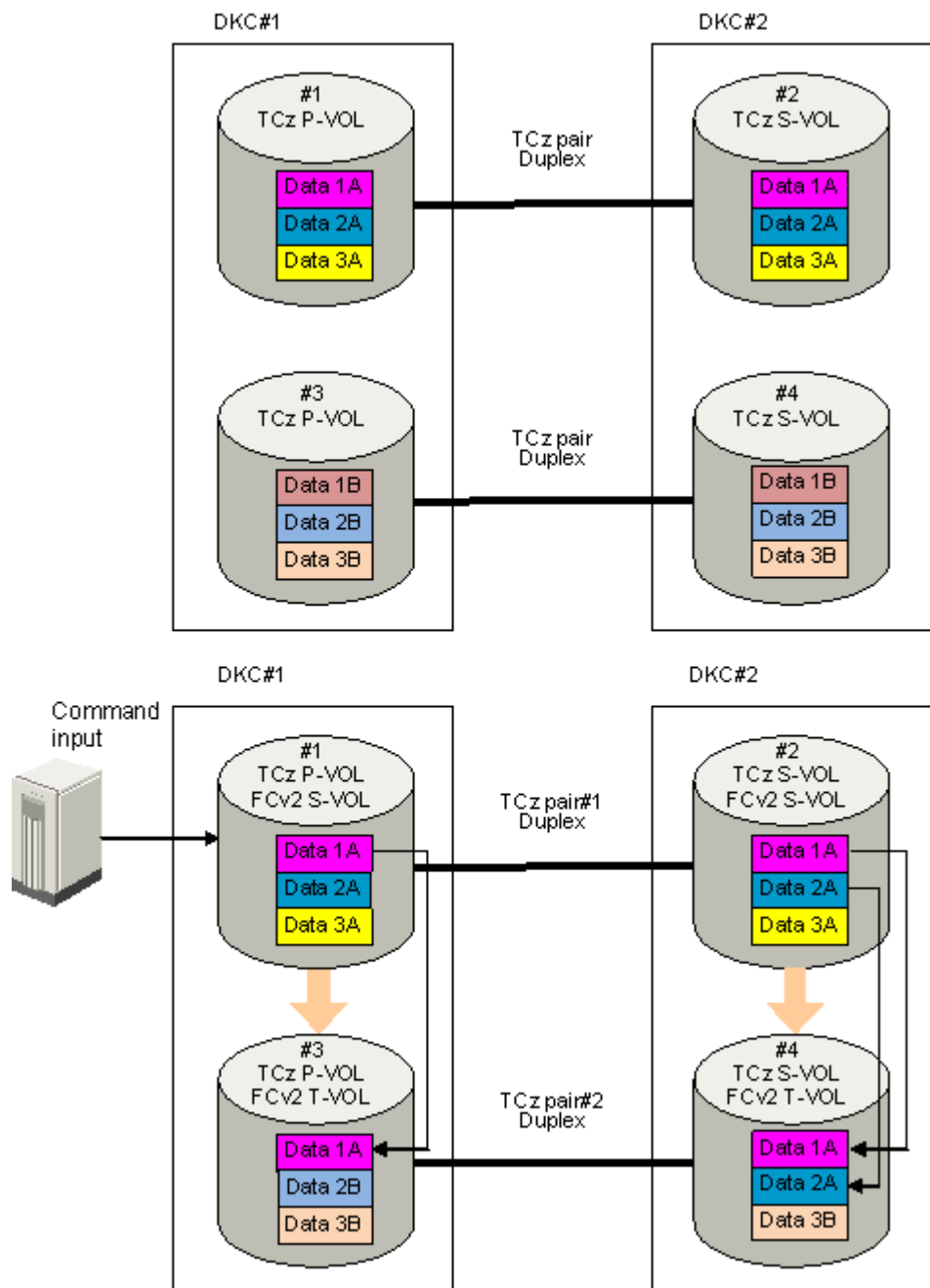

**Figure 18 Preserve Mirror FlashCopy® (COPY mode)**

The Preserve Mirror FlashCopy® function starts to copy after the following occurs:

- The TCz pair #1 P-VOL in DKC#1 becomes the Compatible FlashCopy® V2 S-VOL.
- The TCz pair #2 P-VOL in DKC#1 becomes the Compatible FlashCopy® V2 T-VOL.
- The Compatible FlashCopy® V2 relationship is established in DKC#1.

After establishing the relationship in DKC#1, the TCz #1 S-VOL in DKC#2 becomes the Compatible FlashCopy® V2 S-VOL, and the TCz #2 S-VOL in DKC#2 becomes the Compatible FlashCopy® V2 T-VOL.

Data is copied in each Compatible FlashCopy® V2 relationship, but not in the TCz pairs.

If you issue a command to withdraw the Compatible FlashCopy® V2 relationship, the TCz pair #2 P-VOL in DKC#1 and the pair #2 S-VOL in DKC#2 become inconsistent because the copy operations are asynchronous.

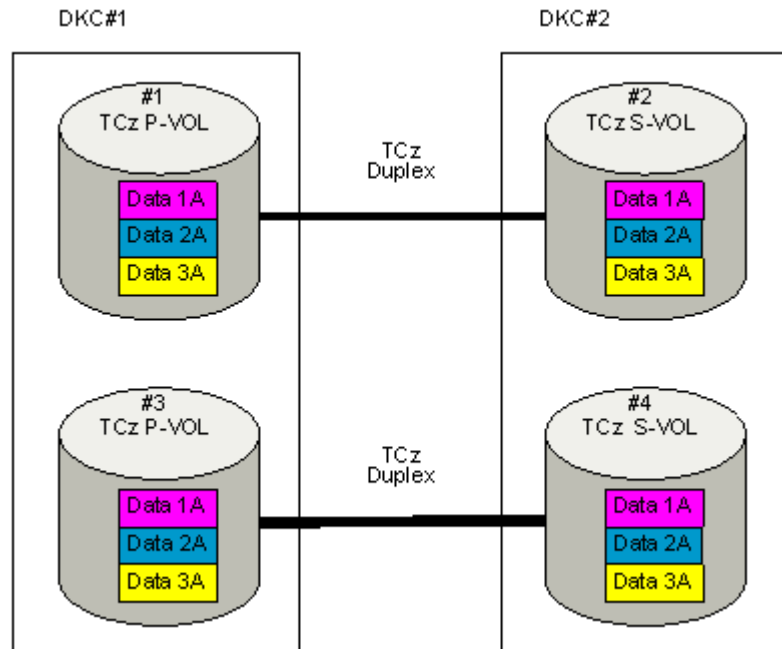

**Figure 19 Preserve Mirror FlashCopy® (COPY mode) after the copy operation is completed**

Each Compatible FlashCopy® V2 relationship is released after the copy operation is completed.

The following table shows the Preserve Mirror FlashCopy® functions you can use with other Compatible FlashCopy® functions.

Preserve Mirror FlashCopy® function	Can be used with other Compatible FlashCopy® functions?
Volume copy	Yes
Dataset copy	Yes
COPY mode	Yes
NOCOPY mode	Yes
Incremental FlashCopy®	Yes
Using consistency groups for dataset copies	Yes
Reverse Restore	Yes

Preserve Mirror FlashCopy® function	Can be used with other Compatible FlashCopy® functions?
FlashCopy® to PPRC Primary	Yes
Fast Reverse Restore	No
HCFCSE	No

## Options required for the Preserve Mirror FlashCopy® function (Compatible FlashCopy® V2 only)

To establish a Compatible FlashCopy® V2 relationship using the Preserve Mirror FlashCopy® function, use the specified options with the following host interfaces:

- DFSMSdss: FCTOPPRCPRIARY(PRESMIRREQ or PRESMIRRPREF)
- TSO: PRESERVEMIRROR(REQUIRED or PREFERRED)
- ICKDSF: PRESERVEMIRROR(REQUIRED or PREFERRED)
- ANTRQST macro: PRESMIR(REQ or PREF)

You also need to specify the following options of FlashCopy® to PPRC Primary Volume when establishing a Compatible FlashCopy® V2 relationship using Preserve Mirror FlashCopy®:

- DFSMSdss: FCTOPPRCPRIARY
- TSO: TGTPPRIM(YES)
- ICKDSF: TGTOKASPPRCPRIM(YES)
- ANTRQST macro: TGTPPRIM(YES)

## Releasing Compatible FlashCopy® relationships

Issue the TSO **FCWITHDR** command to release Compatible FlashCopy® relationships.

The DFSMSdss host interface cannot be used to release Compatible FlashCopy® relationships.

If the following operations or processes are executed, the host server might issue the **FCWITHDR** command automatically, and relationships might be deleted:

- A user deletes a dataset.
- A user initializes a volume.
- A temporary dataset is deleted when a job is completed.

You can release allocated space for a target space-efficient volume (TSE-VOL) by using the following host interfaces and parameters:

- ICKDSF: RELATSPACE
- ANTRQST macro: SPACEREL

If you do not specify these parameters when releasing relations of TSE-VOLs, relations are deleted but the allocated capacity of targets is not released.

## Optimizing volumes

You can optimize Compatible FlashCopy® volumes by using the DFSMSdss utility **DEFRAG** command with the `FASTREPLICATION` option. See *IBM® z/OS® DFSMSdss Storage Administration* for details on the `FASTREPLICATION` option.



**Caution:** The **DEFRAG** command might generate an error when the number of relationships per volume exceeds the maximum number of relationships per volume allowed when all of the following conditions are met:

- The parity group to which the volume belongs is overloaded by I/O requests.
- The **DEFRAG** command is executed with the `FASTREPLICATION(REQUIRED)` option.

To avoid a **DEFRAG** command error, either do not specify the `FASTREPLICATION` option or specify `FASTREPLICATION(PREFERRED)`. They both have the effect of attempting to execute Compatible FlashCopy® and, if it cannot run, to run Concurrent Copy or a host copy operation. If you specify `FASTREPLICATION(REQUIRED)`, and you receive an error, reduce the workload on the parity group.

---

## Interoperability with other products

Compatible FlashCopy® can share volumes with the several software products.

- [Compatible and incompatible products](#)
- [Available operations on Compatible FlashCopy volumes](#)
- [Relationships with volumes used by other products](#)
- [Compatibility of volumes shared by Compatible FlashCopy and other products](#)
- [External volumes](#)
- [Reverse Restore and Fast Reverse Restore when a Compatible FlashCopy volume is used as volume of other products](#)
- [Restricted volumes](#)
- [Using Compatible FlashCopy with ShadowImage for Mainframe](#)
- [Using Compatible FlashCopy with TrueCopy for Mainframe](#)
- [Using Compatible FlashCopy with Universal Replicator for Mainframe](#)
- [Using Compatible FlashCopy with Concurrent Copy and Extended Remote Copy](#)
- [Using Compatible FlashCopy with Dynamic Provisioning for Mainframe](#)
- [Using Compatible FlashCopy with Resource Partition Manager](#)
- [Using Compatible FlashCopy with Virtual LVI](#)

## Compatible and incompatible products

Compatible FlashCopy® can share volumes with the following software products:

- ShadowImage for Mainframe
- TrueCopy for Mainframe
- Universal Replicator for Mainframe
- IBM® Extended Remote Copy (XRC)
- IBM® Concurrent Copy (CC)
- Compatible PAV (PAV)

Compatible FlashCopy® cannot share volumes with the following software products:

- Volume Migration

## Available operations on Compatible FlashCopy® volumes

The following table lists operations that can be performed on the S-VOL or T-VOL of a Compatible FlashCopy® V2 or HCFCSE pair.

Operations		Compatible FlashCopy® V2 volume		HCFCSE volume	
		S-VOL	T-VOL	S-VOL	T-VOL (TSE-VOL)
Volume Retention Manager	Setting Protect attribute	Yes	No	Yes	No
	Setting Read enabled/Write disabled attribute	Yes	Yes	Yes	Yes
	Setting Read/Write enabled attribute	Yes	Yes	Yes	Yes
Cache Residency Manager	Making data in volume reside in cache	Yes	Yes	Yes	No

## Relationships with volumes used by other products

The following table indicates whether you can create Compatible FlashCopy® V2 or HCFCSE relationships with volumes used by another product.

Operation		Compatible FlashCopy® V2 volume		HCFESE volume	
		S-VOL	T-VOL	S-VOL	T-VOL (TSE-VOL)
Volume Retention Manager	Volume with Protect attribute	No	No	No	No
	Volume with Read enabled/Write disabled attribute	Yes	Yes	Yes	Yes
	Volume with Read/Write enabled attribute	Yes	Yes	Yes	Yes
Cache Residency Manager	Volume in which data resides in cache	Yes	Yes	Yes	No
Universal Volume Manager	External volume	Yes	Yes	Yes	No
Dynamic Provisioning for Mainframe	Virtual volume	Yes	Yes	Yes	No
Dynamic Tiering for Mainframe	Virtual volume	Yes	Yes	Yes	No
Active flash for mainframe	Virtual volume	Yes	Yes	Yes	No
Compatible PAV		Yes	Yes	Yes	Yes
Volume Migration		No	No	No	No

## Compatibility of volumes shared by Compatible FlashCopy® and other products

The following table indicates whether you can set attributes on the S-VOL or T-VOL of a Compatible FlashCopy® relationship by using other products.

Product	Compatible FlashCopy® V2 volume		HCFESE volume	
	S-VOL	T-VOL	S-VOL	T-VOL (TSE-VOL)
Cache Residency Manager	Yes	Yes	Yes	No
Universal Volume Manager	Yes	Yes	Yes	No
Dynamic Provisioning for Mainframe	Yes	Yes	Yes	No

Product	Compatible FlashCopy® V2 volume		HCFE volume	
	S-VOL	T-VOL	S-VOL	T-VOL (TSE-VOL)
Dynamic Tiering for Mainframe	Yes	Yes	Yes	No
Active flash for mainframe	Yes	Yes	Yes	No
Compatible PAV	No	No	No	No
Volume Migration	No	No	No	No

## External volumes

External volumes are located in an external storage system and are mapped as internal volumes. For details about Universal Volume Manager and external volumes, see the *Hitachi Universal Volume Manager User Guide*.

Consider the following when using external volumes with Compatible FlashCopy® V2:

- If an external volume is specified as a Compatible FlashCopy® V2 T-VOL, be careful about setting the time of path blockade, which is the time from when the external storage system is disconnected to when the path is blocked. If the time of path blockade watch set for the T-VOL is longer than the time of the MIH timer which is set for the S-VOL for the host side, MIH might occur on the S-VOL and the processing might end abnormally when the external storage system is powered off or when failures occur.
- To give higher priority to host I/O to the S-VOL than to host I/O to the T-VOL, set a smaller time value for the time of the path blockade watch for the T-VOL than the value set for the MIH timer for the S-VOL. By doing this, the Compatible FlashCopy® V2 relationship will be suspended when the T-VOL is blocked because of the path blockade watch, but the host I/O to the S-VOL will continue.
- To give higher priority to T-VOL host I/O than to S-VOL host I/O, use the default setting for the time of path blockade watch for the external volume to be used as the T-VOL.

## Reverse Restore and Fast Reverse Restore when a Compatible FlashCopy® volume is used as volume of other products

The following table indicates whether you can perform Reverse Restore and Fast Reverse Restore on the S-VOL or T-VOL of a Compatible FlashCopy® V2 relationship to which attributes are set by other products.

Product		Compatible FlashCopy® V2 volume		HCFCSE volume	
		S-VOL	T-VOL	S-VOL	T-VOL (TSE-VOL)
Volume Retention Manager	Protect attribute	No	No	No	No
	Read enabled/Write disabled attribute	Yes	Yes	Yes	Yes
	Read/Write enabled attribute	Yes	Yes	Yes	Yes
Cache Residency Manager		Yes	Yes	Yes	No
Universal Volume Manager		Yes	Yes	Yes	No
Dynamic Provisioning for Mainframe		Yes	Yes	Yes	No
Dynamic Tiering for Mainframe		Yes	Yes	Yes	No
Compatible PAV		Yes	Yes	Yes	Yes
Volume Migration		No	No	No	No

## Restricted volumes

You cannot use the following volumes as the S-VOL or T-VOL of a Compatible FlashCopy® relationship:

- Command devices of Business Continuity Manager
- Journal volumes of Universal Replicator for Mainframe
- Pool volumes of Dynamic Provisioning for Mainframe
- Alias volumes of Compatible PAV

## Using Compatible FlashCopy® with ShadowImage for Mainframe

The following figure shows an example of using Compatible FlashCopy® with ShadowImage for Mainframe.

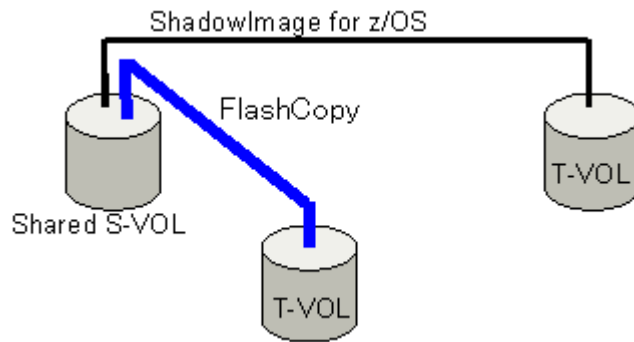

**Figure 20 Compatible FlashCopy® S-VOL shared with ShadowImage for Mainframe**

Typically, you must specify an unpaired volume (with the Simplex status) as a copy source (S-VOL) or a copy target (T-VOL). When you specify an SIz P-VOL as a copy source, you can establish a Compatible FlashCopy® relationship only if the SIz pair does not have the status of Resync-R/REVRSY.

You can establish or release a Compatible FlashCopy® relationship if you meet the requirements described in [Copying by volume on page 26](#) or [Copying by dataset \(Compatible FlashCopy V2 only\) on page 26](#). When there is a Compatible FlashCopy® relationship, you cannot perform backward resynchronization (Reverse Resync or Quick Restore) on the SIz pair.

Even if the SIz P-VOL already has three S-VOLs, you can create up to 16 pairs by specifying the Compatible FlashCopy® relationships with the shared S-VOL (SIz P-VOL) as the copy source.

You cannot create SIz pairs in the following cases, (see the following figure).

- The Compatible FlashCopy® S-VOL (source volume) and the SIz S-VOL (secondary volume) are shared.
- The Compatible FlashCopy® T-VOL and the SIz S-VOL (secondary volume) are shared.
- The Compatible FlashCopy® T-VOL and the SIz P-VOL are shared.

When you use Compatible FlashCopy® volumes, there are some SIz pairs that cannot be created. These are shown in the following diagram.

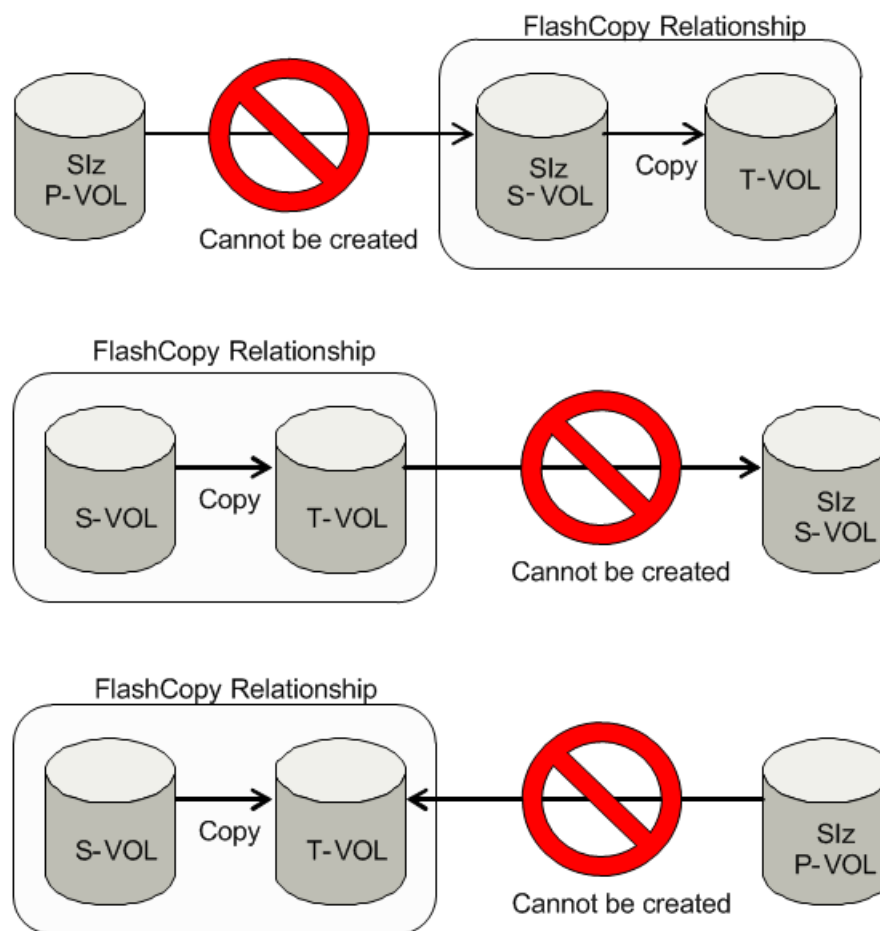

**Figure 21 Compatible FlashCopy® and ShadowImage for Mainframe configurations that cannot be shared**

## Using Compatible FlashCopy® with TrueCopy for Mainframe

### Volumes that can be shared

The following two tables show the combination of volumes that are supported when you share TCz volumes with either Compatible FlashCopy® V2 or HCFCSE volumes.

**Table 3 Compatible FlashCopy V2 and TCz shared volumes**

Compatible FlashCopy® V2 volume	TrueCopy for Mainframe volume	
	P-VOL	S-VOL
S-VOL	Yes	Yes
T-VOL	Yes	No

**Table 4 HCFCSE and TCz shared volumes**

HCFCSE volume	TrueCopy for Mainframe volume	
	P-VOL	S-VOL
S-VOL	Yes	Yes
T-VOL (TSE-VOL)	No	No

## Volumes that cannot be shared

The Compatible FlashCopy® and TCz shared configuration is different from the Compatible FlashCopy® and PPRC shared configuration. For Compatible FlashCopy® and TCz, you cannot create the following pairs (see the following figure):

- A TCz pair that includes a volume functioning as a Compatible FlashCopy® V2 T-VOL and a TCz S-VOL
- A TCz pair that includes a volume functioning as a HCFCSE TSE-VOL and a TCz P-VOL

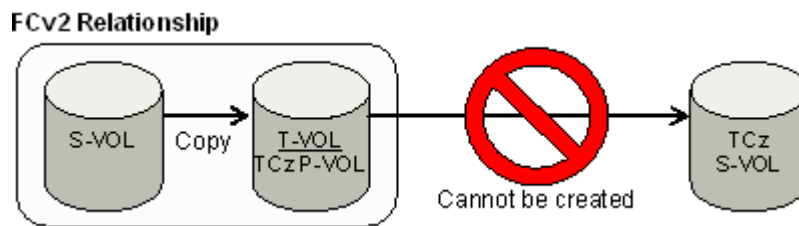

**Figure 22 Compatible FlashCopy® V2 and TCz configurations that cannot be shared**

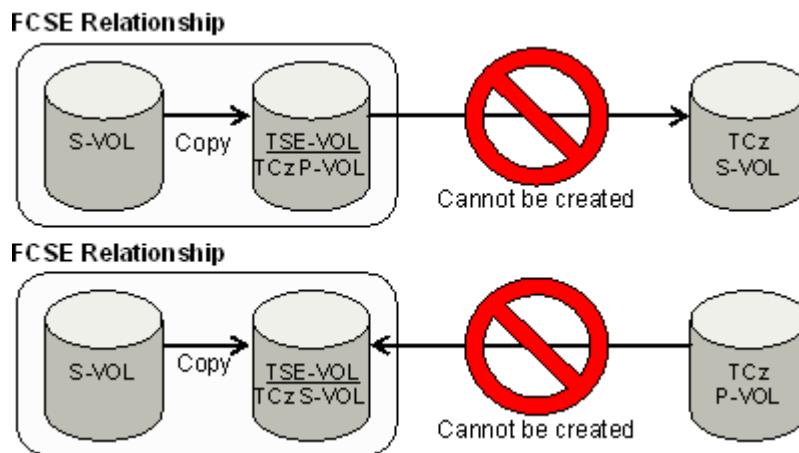

**Figure 23 HCFCSE and TCz configurations that cannot be shared**

A TCz pair volume combined with the multiple primary system and the secondary system using CCI, and the Compatible FlashCopy® source volume or T-VOL cannot be shared.

## Sharing a Compatible FlashCopy® S-VOL and a TCz volume

When sharing a Compatible FlashCopy® S-VOL and a TCz volume, or when using the Remote FlashCopy® function, you must do the following:

- If the Compatible FlashCopy® S-VOL is shared with the TCz S-VOL, specify only one Compatible FlashCopy® T-VOL.
- If the Compatible FlashCopy® S-VOL is shared with the TCz S-VOL, specify a volume of the same emulation type and capacity as the Compatible FlashCopy® S-VOL.
- Set system option modes 20 and 190 to ON in the RCU.
- Use a volume with an emulation type listed in [Table 15 Emulation type combinations supported by Compatible FlashCopy on page 66](#).

When you share a Compatible FlashCopy® S-VOL and a volume of a TCz pair, the status of the TCz pair must be either Duplex, Pending, or Suspend. If the shared TCz volume is an S-VOL, there may be cases when you might not be able to create the Compatible FlashCopy® relationship, as described in the following table.

**Table 5 Shared volume: Compatible FlashCopy S-VOL and TCz**

Shared TCz volume		Status of TCz pair		
		Duplex	Pending	Suspend
TCz	P-VOL	OK	OK <sup>1</sup>	OK
	S-VOL <sup>3, 4, 5</sup>	OK	No <sup>2</sup>	OK
<p><b>Notes:</b></p> <ol style="list-style-type: none"> <li>1. If a TCz P-VOL is in Pending status and you execute an ICKDSF command for Compatible FlashCopy®, the ICKDSF job will end abnormally with CC=12 error. For information about how to avoid that abnormal ending, see <a href="#">ICKDSF command terminates abnormally on page 162</a>.</li> <li>2. You cannot establish the Compatible FlashCopy® relationship, because the data consistency of the Compatible FlashCopy® T-VOL will not be ensured.</li> <li>3. If you establish a Compatible FlashCopy® relationship with the FREEZE option when the TCz S-VOL is shared with the Compatible FlashCopy® source volume, the results of operations differ depending on the type of storage systems at the TCz primary and secondary sites. For details, see Table 6. Note that regardless of the type of storage systems at the TCz primary and secondary sites, if a TCz pair is registered in a consistency group, commands are rejected and the Compatible FlashCopy® relationship cannot be established.</li> <li>4. If a Compatible FlashCopy® relationship is established with the FREEZE option, when the TCz S-VOL is shared with the Compatible FlashCopy® source volume, and when the TCz S-VOL is in the extended long busy (ELB) state, the command to create or resume a pair will be rejected. However, the command to split or delete a pair will be executed normally.</li> <li>5. When the TCz S-VOL is shared with the Compatible FlashCopy® source volume, if a line failure occurs between a primary storage system and a secondary storage system, solve the problem first, and then establish the Compatible FlashCopy® relationship. When a line failure occurs, it might take time (maximum of 2 minutes and 40 seconds) for releasing the FREEZE option, which is the status when writing to the source volume is temporary suspended. Also, it might take time (maximum of 50 seconds when system option mode 995 is set to OFF, and</li> </ol>				

Shared TCz volume	Status of TCz pair		
	Duplex	Pending	Suspend
28 seconds for ON) to establish a Compatible FlashCopy® relationship when the Establish command is executed with the FREEZE option specified for the TCz S-VOL.			

**Table 6 Operation results when the TCz S-VOL is shared with a Compatible FlashCopy source volume, and a Compatible FlashCopy relationship is established with the FREEZE option**

Storage systems at TCz primary and secondary sites		Operation results
Storage system type	DKCMAIN version	
VSP G1000 and G1500, VSP F1500 at both the primary and secondary sites	80-05-23 or later at both the primary and secondary sites	<p>A Compatible FlashCopy® relationship can be established. As with the case of when volumes are not shared with TCz, writing to the P-VOL of a TCz pair will be suspended until the FREEZE state (a state in which writing to the source volume is suspended) is released after a Compatible FlashCopy® relationship has been established. However, when the TCz pair is suspended, writing to the P-VOL of the TCz pair is not suspended.</p> <p>To perform this operation, we recommend you to set the SCP time, which is not longer than 2 minutes (default) for the TCz S-VOL. For SCP time settings, see <a href="#">Suspending write operations to S-VOLs when establishing Compatible FlashCopy V2 relationships on page 98</a> .</p> <p>To release the FREEZE state, execute the <code>FCWITHDR</code> command with the <code>ACTION</code> parameter for the source volume of the Compatible FlashCopy® relationship.</p> <p>For details, see <a href="#">Releasing Compatible FlashCopy V2 relationships on page 115</a>.</p>
	Other than above	<p>The Compatible FlashCopy® relationship can be established when the following conditions are met:</p> <ul style="list-style-type: none"> <li>• When the DKCMAIN program version of a storage system at the secondary site is 80-05-23-xx/xx or later.</li> <li>• When the relationship is established after the TCz pair is created by executing the Establish command with the Remote Compatible FlashCopy® function for the P-VOL of a TCz pair.</li> </ul> <p>However, if data is written to the P-VOL of the TCz pair in the FREEZE state, the TCz pair will be suspended.</p> <p>In this case, you can restore the TCz pair by resynchronizing the pair. For other cases, commands are rejected, and a Compatible FlashCopy® relationship cannot be established.</p>

Storage systems at TCz primary and secondary sites		Operation results
Storage system type	DKCMAIN version	
Other than above		Commands are rejected, and a Compatible FlashCopy® relationship cannot be established.

When you use a Compatible FlashCopy® source volume as a TCz S-VOL, configure the system as follows:

- Connect the different hosts to the local storage system and remote storage system, or connect the host of the local storage system to both the local and remote storage systems.
- Use an iSCSI or Fibre Channel interface to connect the local storage system with the remote storage system.

The above combinations are different from when IBM® FlashCopy® and PPRC are used in conjunction.

The following table describes whether Reverse Restore can be performed when you share a Compatible FlashCopy® S-VOL and a volume of a TCz pair.

**Table 7 Reverse Restore when a Compatible FlashCopy S-VOL is used as a TCz volume**

Shared TCz pair volume		Status of TCz pair		
		Duplex	Pending	Suspend
TCz	P-VOL	OK*	OK*	OK*
	S-VOL	No	No	No
*You can perform Reverse Restore by specifying the following options listed for each host interface: <ul style="list-style-type: none"> <li>• DFSMSdss: FCTOPPRCPRIARY (You cannot perform Fast Reverse Restore when using DFSMSdss.)</li> <li>• TSO: TGTTPRIM(YES)</li> <li>• ICKDSF: TGTOKASPPRCPRIM(YES)</li> <li>• ANTRQST macro: TGTTPRIM(YES)</li> </ul>				

The following table shows whether Fast Reverse Restore can be performed when you share a Compatible FlashCopy® S-VOL and a volume of a TCz pair.

**Table 8 Fast Reverse Restore when a Compatible FlashCopy S-VOL is used as a TCz volume**

Shared TCz pair volume		Status of TCz pair		
		Duplex	Pending	Suspend
TCz	P-VOL	OK*	OK*	OK*
	S-VOL	No	No	No

Shared TCz pair volume	Status of TCz pair		
	Duplex	Pending	Suspend
*You can perform Fast Reverse Restore by specifying the following options listed for each host interface: <ul style="list-style-type: none"> <li>• TSO: TGTTPRIM(YES)</li> <li>• ICKDSF: TGTOKASPPRCPRIM(YES)</li> <li>• ANTRQST macro: TGTTPRIM(YES)</li> </ul>			

## Using a volume as both a Compatible FlashCopy® V2 T-VOL and a TCz P-VOL

Volumes can be used as both a Compatible FlashCopy® V2 T-VOL and a TCz P-VOL as long as they are used in one of the combinations listed in [Table 15 Emulation type combinations supported by Compatible FlashCopy on page 66](#).

The following table shows whether you can share the Compatible FlashCopy® V2 T-VOL and the TCz P-VOL.

**Table 9 Compatible FlashCopy V2 T-VOL shared with the TCz P-VOL**

Shared TCz pair volume		Status of TCz pair		
		Duplex	Pending	Suspend
TCz	P-VOL	OK	OK	OK

The following table indicates the TCz pair status that is required when performing a Reverse Restore and Fast Reverse Restore if a Compatible FlashCopy® V2 T-VOL and the volume of a TCz pair is shared.

**Table 10 TCz pair status required for performing Reverse Restore and Fast Reverse Restore**

Shared TCz pair volume		Status of TCz pair		
		Duplex	Pending	Suspend
TCz	P-VOL	OK	OK	OK

If the Compatible FlashCopy® V2 S-VOL and T-VOL are Dynamic Provisioning for Mainframe volumes, the number of pages remaining in the T-VOL might differ, depending on the timing.

For instructions on sharing Compatible FlashCopy® V2 and TCz volumes, see [Using commands to share Compatible FlashCopy V2 and TCz volumes on page 59](#).

## Using commands to share Compatible FlashCopy® V2 and TCz volumes

### Using DFSMS commands to share Compatible FlashCopy® V2 and TCz volumes

**Note:**

- If the status of the TCz pair is Duplex, you must use a TSO command instead of a DFSMS command.
- You cannot perform Fast Reverse Restore using DFSMSdss commands.

**Sharing a Compatible FlashCopy® V2 S-VOL and a TCz S-VOL**

1. To ensure data consistency, terminate I/O operations to the TCz volume pairs.
2. Suspend the TCz pair. For example:

```
CSUSPEND DEVN(X'dev#) PRIM(X'ssid') serial# X'cca' X'lss')  
SEC(X'ssid' serial# X'lss')
```

3. Set the TCz S-VOL online.  
The host will recognize the dataset on the TCz S-VOL and determine the extent for establishing a Compatible FlashCopy® V2 relationship. If the host is connected to both the TCz P-VOL and S-VOL, the S-VOL label must be rewritten.
4. Establish the Compatible FlashCopy® V2 relationship. For example:

```
COPY FULL INDYNAM(xxxxxxx) OUTDYNAM(yyyyyy) FASTREP(REQ)
```

5. Set the TCz S-VOL offline.
6. Resynchronize the TCz pair.

**Sharing a Compatible FlashCopy® V2 T-VOL and a TCz P-VOL**

1. To ensure data consistency, terminate I/O operations to the volumes of the TCz pairs.
2. Confirm the status of the TCz pair is Duplex.
3. Establish the Compatible FlashCopy® V2 relationship. For example:

```
COPY FULL INDYNAM(xxxxxxx) OUTDYNAM(yyyyyy) FASTREP(REQ)  
FCTOPPRCPRIARY
```

4. After establishing the relationship, you can resume I/O operations to the volumes of the TCz pairs.

### Using TSO commands to share Compatible FlashCopy® V2 and TCz volumes

**Sharing a Compatible FlashCopy® V2 S-VOL and a TCz S-VOL**

1. To ensure data consistency, terminate I/O operations to the volumes of the TCz pairs.

2. Establish the Compatible FlashCopy® V2 relationship. For example:

```
FCESTABL SDEVN(X'xxxx') TDEVN(X'yyyy') MODE(COPY)
ONLINTGT(YES)
```

3. After establishing the relationship, you can resume I/O operations to the volumes of the TCz pairs.

### Sharing a Compatible FlashCopy® V2 T-VOL and a TCz P-VOL

1. To ensure data consistency, terminate I/O operations to the volumes of TCz pairs.
2. Confirm that the status of the TCz pair is Duplex.
3. Establish the Compatible FlashCopy® V2 relationship. For example:

```
COPY FULL INDYNAM(xxxxxx) OUTDYNAM(yyyyyy) FASTREP(REQ)
TCTOPPCPRIMARY
```

4. After establishing the relationship, you can resume I/O operations to the volumes of the TCz pairs.

## Using ICKDSF commands to share Compatible FlashCopy® V2 and TCz volumes

For details about the ICKDSF command for creating Compatible FlashCopy® V2 relationships, see [Establishing relationships for Compatible FlashCopy V2 on page 76](#).

### Sharing a Compatible FlashCopy® V2 S-VOL and a TCz S-VOL

1. To ensure data consistency, terminate I/O operations to the volumes of TCz pairs.
2. Establish the Compatible FlashCopy® V2 relationship. For example:

```
FLASHCPY ESTABLISH UNIT(X'dev#')
TARGETVOL(X'ssid',X'cca',lss) ONLINTGT(YES)
```

3. After establishing the relationship, you can resume I/O operations to the volumes of the TCz pairs.

### Sharing a Compatible FlashCopy® V2 T-VOL and TCz P-VOL

1. To ensure data consistency, terminate I/O operations to the volumes of TCz pairs.
2. Confirm that the pair status of the TCz is Duplex.
3. Establish the Compatible FlashCopy® V2 relationship. For example:

```
COPY FULL INDYNAM(xxxxxx) OUTDYNAM(yyyyyy) FASTREP(REQ)
TCTOPPCPRIMARY
```

4. After establishing the relationship, you can resume I/O operations to the volumes of the TCz pairs.

# Using Compatible FlashCopy® with Universal Replicator for Mainframe

The following tables describe the allowed volume combinations when you share Compatible FlashCopy® and URz volumes.

**Table 11 When a Compatible FlashCopy V2 volume can be used as a URz volume**

Compatible FlashCopy® V2 volume	URz volume	
	P-VOL	S-VOL
S-VOL	Yes	No
T-VOL	Yes	No

**Table 12 When a HCFESE volume can be used as a URz volume**

HCFESE volume	URz volume	
	P-VOL	S-VOL
S-VOL	Yes	No
T-VOL	Yes	No

## Using a Compatible FlashCopy® S-VOL as a URz P-VOL

- You can use a Compatible FlashCopy® S-VOL as a URz P-VOL regardless of the status of the URz pair.
- A URz P-VOL combined with the multiple primary system and the secondary system using CCI, and the Compatible FlashCopy® S-VOL cannot be shared.
- The URz P-VOL in 3DC multi-target configuration using 3 URz sites and a Compatible FlashCopy® source volume cannot be shared.

## Using a Compatible FlashCopy® T-VOL as a URz P-VOL

You can use a Compatible FlashCopy® T-VOL as a URz P-VOL regardless of the status of the URz pair. Note the following:

- If a Compatible FlashCopy® volume and a URz volume cannot be shared, the host might receive a report that a Compatible FlashCopy® T-VOL is a PPRC P-VOL.
- If the S-VOL and T-VOL of a Compatible FlashCopy® relationship are Dynamic Provisioning for Mainframe volumes, the number of pages remaining in the T-VOL might differ, depending on the timing.
- If a Compatible FlashCopy® relationship is suspended during a copy operation, the shared URz pair is also suspended. Since data is copied asynchronously in URz, there will be a noticeable delay between the time

the Compatible FlashCopy® is suspended and when the URz pair is suspended.

- A URz P-VOL combined with the multiple primary system and the secondary system using CCI, and the Compatible FlashCopy® T-VOL cannot be shared.
- The URz P-VOL in 3DC multi-target configuration using 3 URz sites and a Compatible FlashCopy® target volume cannot be shared.

## Using Compatible FlashCopy® with Concurrent Copy and Extended Remote Copy

The following table describes the allowed volume combinations when you share Compatible FlashCopy® with Concurrent Copy (CC) and Extended Remote Copy (XRC).

**Table 13 When a Compatible FlashCopy volume can be used as a CC or XRC volume**

Compatible FlashCopy® volume	CC or XRC volume	
	P-VOL	S-VOL
S-VOL	Yes	Yes
T-VOL	No	No <sup>1</sup>

**1.** Do not share a Compatible FlashCopy® T-VOL with a CC or XRC S-VOL. If you do so, the data in the volume will be overwritten by the two programs and destroyed.

The following table indicates whether you can perform a Reverse Restore and Fast Reverse Restore when a Compatible FlashCopy® volume is used as a CC or XRC volume.

**Table 14 Reverse Restore and Fast Reverse Restore when a Compatible FlashCopy volume is used as a CC or XRC volume**

Compatible FlashCopy® volume	CC or XRC volume	
	P-VOL	S-VOL
S-VOL	No	No*

\* Do not perform Reverse Restore or Fast Reverse Restore when an S-VOL is shared by Compatible FlashCopy® and CC or XRC. Doing so will overwrite the data in the S-VOL.

## Using Compatible FlashCopy® with Dynamic Provisioning for Mainframe

When you use a DP-VOL as a Compatible FlashCopy® T-VOL, the host cannot access the volume if the relationship status becomes suspended because the

pool becomes full. To recover from suspended status, you must release the Compatible FlashCopy® relationship.

## **Using Compatible FlashCopy® with Resource Partition Manager**

You can create a Compatible FlashCopy® relationship regardless of whether the S-VOL and the T-VOL are assigned to the same resource group.

## **Using Compatible FlashCopy® with Virtual LVI**

To create a relationship using Virtual LVI volumes, the capacity of the S-VOL and the T-VOL must be the same.



## Preparing for Compatible FlashCopy® operations

This chapter describes configuration requirements and Compatible FlashCopy® options used for tuning the host I/O impact of Compatible FlashCopy® operations.

- [Requirements for using Compatible FlashCopy](#)
- [Compatible FlashCopy Options](#)
- [Powering off the storage system during Compatible FlashCopy](#)
- [Installing and removing Compatible FlashCopy](#)
- [License capacity requirements](#)

## Requirements for using Compatible FlashCopy®

You can establish a Compatible FlashCopy® relationship for unpaired volumes or SIZ volumes regardless of the pair status.

The following table shows the emulation type combinations supported by Compatible FlashCopy®.

**Table 15 Emulation type combinations supported by Compatible FlashCopy**

Emulation type of S-VOL	Emulation type of T-VOL						
	3390-1	3390-2	3390-3	3390-9	3390-L	3390-M	3390-A
3390-1	Yes	Yes	Yes	Yes	Yes	Yes	Yes
3390-2	Yes	Yes	Yes	Yes	Yes	Yes	Yes
3390-3	Yes	Yes	Yes	Yes	Yes	Yes	Yes
3390-9	Yes	Yes	Yes	Yes	Yes	Yes	Yes
3390-L	Yes	Yes	Yes	Yes	Yes	Yes	Yes
3390-M	Yes	Yes	Yes	Yes	Yes	Yes	Yes
3390-A	Yes	Yes	Yes	Yes	Yes	Yes	Yes

For 3390 emulation, you can specify volumes of different emulation types for the S-VOL and T-VOL (for example, a 3390-3 S-VOL paired with a 3390-9 T-VOL). The specified extent must be within the range of the user cylinders in each volume.

## Compatible FlashCopy® Options

Use the options described in the following table to manage the host I/O impact of Compatible FlashCopy® operations in your environment.

In the following cases, set options if necessary because the background copying operation is performed in NOCOPY mode:

- For the applicable relationship, when you execute the **Establish** command with NOCOPY2COPY specified.
- While deleting the applicable relationship, when you execute the **Withdraw** command with DDSW(YES) specified.
- When you delete a data set, or a host issues the **Withdraw** command with DDSW(YES) specified.

**Table 16 Compatible FlashCopy options**

Option	Description
FC Slower Copy1	Suppresses Compatible FlashCopy® copy operations, and gives priority to host I/O operations. For details, see <a href="#">FC Slower Copy1 option on page 67</a> .  Note: If the FC Slower Copy2 option is enabled, the FC Slower Copy1 option will be ignored. Make sure the FC Slower Copy2 option is disabled when using this option.
FC Slower Copy2	Suppresses Compatible FlashCopy® copy operations, and gives priority to host I/O operations. This option suppresses more Compatible FlashCopy® background copy operations than the FC Slower Copy1 option. For details, see <a href="#">FC Slower Copy2 option on page 67</a> .
FC Ext. Slower Copy1	Suppresses Compatible FlashCopy® copy operations, and gives priority to host I/O operations. For details, see <a href="#">FC Ext. Slower Copy1 option on page 68</a> .  Note: If the FC Slower Copy1, FC Slower Copy2, or FC Ext. Slower Copy2 option is enabled, this option will be ignored. Make sure those options are disabled when selecting this option.
FC Ext. Slower Copy2	Suppresses Compatible FlashCopy® copy operations, and gives priority to host I/O operations. This option suppresses more Compatible FlashCopy® background copy than with the FC Ext. Slower Copy1 option. For details, see <a href="#">FC Ext. Slower Copy2 option on page 68</a> .

## FC Slower Copy1 option

Use this option is to give priority to host I/O response over background copy processing of Compatible FlashCopy® relationships. When this option is enabled, the maximum number of Compatible FlashCopy® relationships that can be copied simultaneously in the background is reduced by 50%, thus improving host I/O response. When the FC Slower Copy2 option is enabled, the FC Slower Copy1 option is invalid.

When Compatible FlashCopy® background copy operations are suppressed by the FC Slower Copy1 option, the time required for background copying increases. Background copy operation time vary depending on the relationships, so the FC Slower Copy1 option will not necessarily double the time compared to when the option is not specified.

If ShadowImage pairs exist in the same parity group as Compatible FlashCopy® volumes, the host I/O response time might not improve.

## FC Slower Copy2 option

Use this option is to give priority to host I/O response over background copy processing of Compatible FlashCopy® relationships. When this option is enabled, the maximum number of Compatible FlashCopy® relationships that can be copied simultaneously in the background is reduced to 25% compared to when the option is not specified, thus improving the host I/O response time.

The FC Slower Copy1 and FC Slower Copy2 options perform the same basic function. The difference is that the FC Slower Copy2 option provides the best host I/O response because it suppresses more background copy operations than the FC Slower Copy1 option. When the FC Slower Copy2 option is enabled, the FC Slower Copy1 option is invalid.

When Compatible FlashCopy® background copy operations are suppressed by the FC Slower Copy2 option, the time required for background copying increases. Background copy operation time vary depending on the relationships, so the FC Slower Copy2 option will not necessarily quadruple the time compared to when the option is not specified.

If ShadowImage pairs exist in the same parity group as Compatible FlashCopy® volumes, the host I/O response time might not improve.

### **FC Ext. Slower Copy1 option**

Use this option is to give priority to host I/O response over background copy processing of Compatible FlashCopy® relationships. When the FC Ext. Slower Copy1 option is enabled and MP blade usage exceeds 65%, background copy operations are suppressed, thus host I/O response improves.

When Compatible FlashCopy® background copy operations are suppressed by the FC Ext. Slower Copy1 option, the time required for background copying increases. When the FC Ext. Slower Copy2 option is enabled, the FC Ext. Slower Copy1 option is invalid.

### **FC Ext. Slower Copy2 option**

Use this option is to give priority to host I/O response over background copy processing of Compatible FlashCopy® relationships. When the FC Ext. Slower Copy2 option is enabled and MP blade usage exceeds 50%, background copy operations are suppressed, thus host I/O response improves.

When Compatible FlashCopy® background copy operations are suppressed by the FC Ext. Slower Copy2 option, the time required for background copying increases. When the FC Ext. Slower Copy2 option is enabled, the FC Ext. Slower Copy1 option is invalid.

## **Powering off the storage system during Compatible FlashCopy®**

This section describes what occurs when you power off the storage system during Compatible FlashCopy® operations, and then power on the storage system later. What occurs depends on the status of the shared memory when power is restored to the storage system.



**WARNING:** If data in shared memory is not restored when power is restored to the storage system, problems might occur during operations. To reduce potential shared memory problems, withdraw as many Compatible FlashCopy® relationships as possible before powering off the storage system.

---

### **Data in shared memory is restored**

The state of all Compatible FlashCopy® relationships is fully restored upon power up. All relationships in COPY mode automatically restart their background copy operations. All relationships that are in COPY mode automatically restart their background copy when power is restored to the storage system.

### **Data in shared memory is not restored**

Relationships that were not withdrawn before powering off will have their T-VOLs blocked and inaccessible from host when power is restored. The T-VOLs are blocked to prevent access to inconsistent data. To restore the T-VOLs to normal status, the LDEVs must be forcibly restored.

If the T-VOL is an external volume, the storage system might start normally and the T-VOL might not be blocked, even when data in shared memory is lost. However, even if the storage system starts normally, it is likely that the data on the T-VOL is inconsistent. Therefore, delete the data on the T-VOL or initialize the T-VOL.

## **Installing and removing Compatible FlashCopy®**

To enable Compatible FlashCopy® on the storage system, you must install and enable Compatible FlashCopy® features and software on the storage system.

In some cases, you might need to install additional shared memory before installing Compatible FlashCopy®. For details, contact your Hitachi Data Systems account representative.

For information about licenses, see the *System Administrator Guide*.

## **Installing Compatible FlashCopy®**

### **Procedure**

1. Determine if you need to install additional shared memory.  
For details, contact your Hitachi Data Systems representative.
2. Set all devices to be used with Compatible FlashCopy® offline.
3. In the Device Manager - Storage Navigator main window, enter the Compatible FlashCopy® license key and click **Apply**.

4. Set all devices to be used with Compatible FlashCopy® online.
5. Execute the `devserv` command with the `VALIDATE` option of the `QDASD` option to the devices in the storage system.

An example of the `devserv` command follows:

```
devserv QDASD, 4200, VALIDATE
```

The `devserv` command displays information for device number 4200 and the associated controller.

If any devices fail extended function checking, you must find and correct the problem before attempting to use the device with Compatible FlashCopy®.

6. Establish Compatible FlashCopy® relationships.
7. Use the `FCQUERY` command or Device Manager - Storage Navigator to confirm that all of the Compatible FlashCopy® relationships have been created.

## Removing Compatible FlashCopy®

### Procedure

1. Use host commands to withdraw all Compatible FlashCopy® relationships.
2. Use the `FCQUERY` command or Device Manager - Storage Navigator to confirm that all of the Compatible FlashCopy® relationships have been deleted.
3. Set all devices used by Compatible FlashCopy® offline.
4. In the Device Manager - Storage Navigator window, click **Administration** in the Explorer pane on the left side.
5. In the navigation tree, click **License Keys**, and then select **Compatible FlashCopy**.
6. At the top of the window, click **Remove Licenses**, and then select the appropriate actions to complete the process.
7. Set all devices used by Compatible FlashCopy® back online.  
The host recognizes that Compatible FlashCopy® has been removed.
8. Execute the `devserv` command with the `VALIDATE` option of `QDASD` to the devices in the storage system.  
For an example of the `devserv` command, see [Installing Compatible FlashCopy on page 69](#).
9. From the host, perform the mainframe host path online operation.  
Compatible FlashCopy® does not support the `REMOVEFCPY` parameter of the command.

## License capacity requirements

The total volume capacity (S-VOLs and T-VOLs) used by Compatible FlashCopy® must always be less than or equal to the license capacity installed in the storage system.

### License capacity for Compatible FlashCopy® V2

- The total capacity of Compatible FlashCopy® V2 S-VOLs and T-VOLs must be less than or equal to the installed license capacity.
- If thin-provisioned (Dynamic Provisioning) volumes are used as Compatible FlashCopy® V2 volumes, the Dynamic Provisioning pool capacity is used to determine the used volume capacity, not the capacity of individual thin-provisioned volumes. Increasing the Dynamic Provisioning pool capacity might result in exceeding the installed license capacity.



**Caution:** If the total volume capacity required by Compatible FlashCopy® V2 exceeds the installed license capacity, you can continue to use Compatible FlashCopy® V2 for 30 days. After that, you can delete Compatible FlashCopy® V2 relationships, but you cannot perform any other Compatible FlashCopy® V2 operations.

---

### License capacity for HCFCSE

- The total capacity of HCFCSE S-VOLs and T-VOLs must be less than or equal to the installed license capacity.
- For source volumes, the capacity is added in the same way as for Compatible FlashCopy® V2. For target volumes, which are TSE-VOLs, the capacity for the tracks in use is added track by track. This license capacity is not updated immediately. Therefore, the installed license capacity might be exceeded by multiple write operations to the pools.



**Caution:** If the total volume capacity required by HCFCSE exceeds the installed volume capacity, you can continue to use HCFCSE for 30 days. After that, you can delete HCFCSE relationships, but you cannot perform any other HCFCSE operations.

---



# Performing Compatible FlashCopy® V2 operations

This chapter describes how to use host interface commands to perform Compatible FlashCopy® V2 operations. The operations include establishing relationships, withdrawing relationships, and querying relationship status. It describes all of the command options you can set.

- [Commands for Compatible FlashCopy V2](#)
- [Supported operating systems for Compatible FlashCopy V2](#)
- [Setting local replica options](#)
- [Establishing relationships for Compatible FlashCopy V2](#)
- [Establishing Compatible FlashCopy V2 relationships by extent](#)
- [Using z/VM CP to establish Compatible FlashCopy V2 relationships](#)
- [Suspending write operations to S-VOLs when establishing Compatible FlashCopy V2 relationships](#)
- [Viewing details of Compatible FlashCopy V2 relationships](#)
- [Viewing resource information from Device Manager - Storage Navigator](#)
- [Releasing Compatible FlashCopy V2 relationships](#)

## Commands for Compatible FlashCopy® V2

You can only issue Compatible FlashCopy® V2 commands from the host. Compatible FlashCopy® V2 supports the following host interfaces and commands to establish and control Compatible FlashCopy® V2 operations.

- PPRC TSO commands:

- **FCESTABL**
- **FCWITHDR**
- **FCQUERY**

To use the PPRC TSO commands when the host system is protected by RACF, you must add the PPRC TSO command names to the AUTHCMD PARM of IKJTSOxx in SYS1.PARMLIB.

- DFSMSdss commands:

- **COPY FULL**
- **COPY DS**

Compatible FlashCopy® V2 supports VSAM datasets. However, if you specify attributes for the copy source extents that differ from those specified for the target extents, DFSMSdss invokes a different program, such as IDCAMS, which might cause Compatible FlashCopy® V2 to operate differently for VSAM datasets.

- ICKDSF commands:

- **FLASHCPY ESTABLISH**
- **FLASHCPY WITHDRAW**
- **FLASHCPY QUERY**
- **FLASHCPY QUERY RELATIONS**

- ANTRQST macro commands:

- **REQUEST=FCESTABLISH**
- **REQUEST=FCWITHDRAW**
- **REQUEST=FCQUERY**

- z/VM CP commands:

- **FLASHCOPY**
- **FLASHCOPY ESTABLISH**
- **FLASHCOPY BACKGNDCOPY**
- **FLASHCOPY RESYNC**
- **FLASHCOPY TGTWRITE**
- **FLASHCOPY WITHDRAW**
- **QUERY VIRTUAL FLASHCOPY**

For more information about these commands, see the appropriate IBM® documentation.

## Supported operating systems for Compatible FlashCopy® V2

The following operating systems are supported for Compatible FlashCopy® V2:

- z/OS V1R0 and later
- z/VM V5R3 and later

Earlier versions of these operating systems require the appropriate program temporary fixes (PTFs).

## Setting local replica options

This section describes how to change system options using Device Manager - Storage Navigator.

For details about how to change system options using Command Control Interface, see the *Command Control Interface User and Reference Guide*.

### Before you begin

- You must have the Storage Administrator (Local Copy) role.

### Procedure

1. Open the **Edit Local Replica Options** window.  
Select **Actions > Local Replication > Edit Local Replica Options**.
2. In the **Edit Local Replica Options** window, select **Mainframe** for System Type.
3. Select one of the following **System Options**:
  - **Swap & Freeze**: Saves data immediately after a Quick Restore as-is. When you enable this option and execute Quick Restore, update copying after Quick Restore is prevented, and the secondary volume in DUPLEX status is saved without being updated.
  - **Host I/O Performance**: Gives I/O response a higher priority than volume copy time.
  - **FC Slower Copy1**. Reduces background copy processing by 50% to improve the host I/O response time.
  - **FC Slower Copy2**. Reduces background copy processing to 25% to improve the host I/O response time.
  - **FC Ext. Slower Copy1**. Reduces background copy processing when MP blade utilization exceeds 65%.
  - **FC Ext. Slower Copy2**. Reduces background copy processing when MP blade utilization exceeds 50%.
4. Click **Finish**.
5. In the **Confirm** window, enter a **Task Name**, and then click **Apply**.

If you selected **Go to tasks window for status**, the **Task** window opens when the task begins.

### Related concepts

- [Edit Local Replica Option wizard](#) on page 171

## Establishing relationships for Compatible FlashCopy® V2

You can establish Compatible FlashCopy® V2 volume relationships using the following host interfaces to the storage system:

- PPRC TSO
- DFSMSdss
- ICKDSF
- ANTRQST macro
- z/VM CP



**Caution:** If more than 100 Compatible FlashCopy® V2 relationships are established at the same time, a time-out might occur. To avoid timeouts, divide the tasks into small groups and establish relationships at intervals of approximately 5 seconds per 100 relationships.

## Using PPRC TSO to establish Compatible FlashCopy® V2 relationships by volume

The following table describes the parameters you can use with the **FCESTABL** command to establish Compatible FlashCopy® V2 relationships by volume.

**Table 17 FCESTABL command parameters for establishing relationships by volume**

Parameter	Value	Description
SDEVN	Source device number	Specify the device address of the S-VOL on which you want to execute the <b>FCESTABL</b> command. (This parameter is required.)
TDEVN	Target device number	Specify the device address of the T-VOL on which you want to perform the <b>FCESTABL</b> command. (This parameter is required.)
MODE	COPY	All of the data in the copy range of the volume specified as the source by SDEVN is copied in the background to the volume specified as the target by TDEVN. The relationship ends automatically, and all of the data is copied.  COPY is the default mode.
	NOCOPY	Data is not copied in the background. The relationship does not end automatically, even if all of the data is copied over time. To withdraw the relationship, you must use the <b>FCWITHDR</b> command. In the following cases, data is copied

Parameter	Value	Description
		<p>from the S-VOL to the T-VOL before access occurs in the following cases:</p> <ul style="list-style-type: none"> <li>• There is access to write data on the copy source of the specified area within the extent.</li> <li>• There is access to write data on the copy target of the specified area within the extent.</li> <li>• There is access to read data on the copy target of the specified area within the extent.</li> </ul>
	NOCOPY2COPY	A relationship created using NOCOPY mode is changed to COPY mode, and a background copy occurs for data not already copied to the T-VOL. When all of the data is copied, the relationship is released automatically.
ONLINTGT	YES	The path group is not checked. The relationship is established even if the copy target is online.
	NO	<p>The path group is checked. The relationship is not established when the copy target is online.</p> <p>NO is the default setting.</p>
INCREMENTAL	YES	<p>Establishes a relationship that includes all of the tracks in the volume. If you specify YES for this parameter and COPY for the MODE parameter, the relationship will be maintained after the background copy operation is completed, and the differential data between the S-VOL and the T-VOL will be managed. As long as the relationship is maintained, you cannot update the T-VOL.</p> <p>The differential data between the S-VOL and the T-VOL will be copied when you re-execute the <b>FCESTABL</b> command with the INCREMENTAL parameter, or you execute the <b>FCESTABL</b> command (Reverse Restore) with the S-VOL and the T-VOL reversed.</p>
	NO	<p>The relationship will be deleted after the background copy operation is completed.</p> <p>NO is the default setting.</p>
	YTW	<p>The relationship remains in effect after background copy operation is completed. Data can be written to the T-VOL. Subsequent changes are tracked so that future operations are performed incrementally. This relationship continues until explicitly terminated by a Withdraw request.</p> <p><b>Note:</b> The target is writable while the incremental relationship is active. Any writes to the target during this period are overwritten if a subsequent incremental copy is performed, keeping the target a true copy of the source. If the relationship is reversed, changes made to the target are also made to the source.</p>
TGTPPRIM	YES	Specify YES when the Compatible FlashCopy® V2 T-VOL and the TCz P-VOL (or URz P-VOL) share the same volume.
	NO	<p>Specify NO when the Compatible FlashCopy® V2 T-VOL and the TCz P-VOL (or URz P-VOL) do not share the same volume.</p> <p>NO is the default setting.</p>

Parameter	Value	Description
TGTUCB	YES	Specifies the device number (device address) of the T-VOL on which you want to execute the <b>FCESTABL</b> command. To specify the device number, use the TDEVN parameter.  YES is the default setting.
	NO	Specifies the serial number, CU number, and LDEV number of the T-VOL on which you want to execute the <b>FCESTABL</b> command. To specify this number, use the TARGET parameter instead of the TDEVN parameter.
TARGET	Serial number CU number LDEV number of the T-VOL	Specifies the serial number, CU number, and LDEV number of the T-VOL on which you want to execute the <b>FCESTABL</b> command.  Use this parameter when the TGTUCB parameter is set to NO.
REMOTE	YES	Use the Remote FlashCopy® function to establish a relationship.
	NO	Do not use the Remote FlashCopy® function.  NO is the default setting.
DEVN	TCz source device number	Specifies the TCz source device number (device address).  Use this parameter when the REMOTE parameter is set to YES.
SOURCE	Serial number CU number LDEV number of the S-VOL	Specifies the serial number, CU number, and LDEV number of the S-VOL on which you want to execute the <b>FCESTABL</b> command.  Use this parameter when the REMOTE parameter is set to YES.
SSID	SSID	Specifies the SSID of the CU on which you establish the Compatible FlashCopy® V2 relationship.  Use this parameter when the REMOTE parameter is set to YES.
ACTION	FREEZE	Suspends write operations from the host to all S-VOLs. For further information, see <a href="#">Suspending write operations to S-VOLs when establishing Compatible FlashCopy V2 relationships on page 98</a> .
	FRR	Reverses the direction of the Compatible FlashCopy® V2 relationship, restoring the source volume to the state it was in when it was last flashed to the target. Changed tracks are copied back from the target to the source.
PRESERVEMIRROR or PRESMIR	NO	Establishes the relationship without using the Preserve Mirror FlashCopy® function.  NO is the default setting.
	REQUIRED or REQ	Establishes the relationship by using the Preserve Mirror FlashCopy® function. If the relationship cannot be established, the command is rejected. You must also specify TGTPPRIM(YES).
	PREFERRED or PREF	Establishes the relationship by using the Preserve Mirror FlashCopy® function. If the relationship cannot be

Parameter	Value	Description
		established, the copy operation is executed using the existing FlashCopy® to PPRC Primary Volume function. You must also specify TGTPPRIM(YES).
SETGTOK*	YES	Specifies that the T-VOL can be a TSE-VOL.
	NO	Specifies that the T-VOL cannot be a TSE-VOL.
*Valid in Compatible FlashCopy® SE		

To perform volume copying:

### Procedure

1. Set the T-VOL offline.
2. Execute the **FCESTABL** command without specifying the EXTENTS and XTNTLST parameters.
3. Before you set the T-VOL online to an LPAR that has the S-VOL online, you must change the VOLSER of the T-VOL.  
When the VTOC is copied, the VOLSER of the S-VOL and the T-VOL become identical, so this step is necessary before setting the T-VOL online.
4. Set the T-VOL online.

### FCESTABL command example

The following is an example of **FCESTABL** command usage. In this example, the **FCESTABL** command specifies that the data in source device 4202 will be copied to target device 4203 using COPY mode while device 4203 is online.

```
FCESTABL SDEVN(X'4202') TDEVN(X'4203') MODE(COPY) ONLINTGT(YES)
```

## Using DFSMSdss to establish Compatible FlashCopy® V2 relationships by volume

Use the DFSMSdss **COPY FULL** command to perform a Compatible FlashCopy® V2 volume copy operation.

The following table describes the parameters you can use with the DFSMSdss command to establish Compatible FlashCopy® V2 relationships by volumes.

**Table 18 Parameters for DFSMSdss, Volume copying**

Parameter	Value	Description
COPYVOLID <sup>1</sup>	N/A	Enables you to select whether you want to copy the ID label (VOLSER). When specified, the VOLSER of the source volume is

Parameter	Value	Description
		copied to the target volume. When <b>COPYVOLID</b> is executed, the target volume is placed offline automatically.  <b>COPYVOLID</b> must be specified for volumes controlled by SMS. When the <b>DUMPCONDITIONINO</b> command is specified, the <b>VOLSER</b> of the source volume is copied to the backup tape or disk. In this case, you do not need to specify <b>COPYVOLID</b> to copy the volume label.
DUMPCONDITIONINO <sup>1</sup>	N/A	Specifies that the purpose of the copy operation is to create a backup copy and not for using the copied volume with an application.
FCNOCOPY	N/A	Sets the copy operation mode to <b>NOCOPY</b> . When specified, the background copy operation is not performed.
FCNOCOPYTOCOPY	N/A	Specifies that a relationship established using <b>NOCOPY</b> mode will use the <b>COPY</b> option, and a background copy operation starts. When all of the data is copied, the relationship is released automatically.
FASTREPLICATION	PREFERRED	Executes the Compatible FlashCopy® V2 copy operation as a priority. If Compatible FlashCopy® V2 cannot be used, Concurrent Copy or a host copy operation is executed.  When <b>FASTREPLICATION</b> is not specified, the copy operation will be executed as if <b>PREFERRED</b> was specified.
	REQUIRED	Executes the Compatible FlashCopy® V2 copy operation unconditionally. If Compatible FlashCopy® V2 cannot be used, an error is returned, no relationship is established, and no copy operation is executed.
	NONE	Specifies that Compatible FlashCopy® V2 is not to be used for the copy operation.
FCFULLVOLUMERELATION	N/A	Creates an Compatible FlashCopy® V2 relationship for all areas of the S-VOL (areas that have datasets and areas that do not have datasets).
FCFASTREVERSERESTORE	N/A	Replaces the S-VOL and T-VOL of an Compatible FlashCopy® V2 relationship with each other, and then performs the <b>FastReverseRestore</b> function.
FCCGFREEZE	N/A	Temporarily suspends write operations from the host to the S-VOLs when you establish relationships to maintain data consistency. Use the <b>DFSMSdss CGCREATE</b> command or the TSO <b>FCWITHDR</b> command to resume the write operation from the host to the S-VOLs.
FCINCREMENTAL	N/A	To use the Incremental FlashCopy® function, use <b>FCINCREMENTAL</b> . For details about the Incremental FlashCopy® function, see <a href="#">Reverse Restore (Compatible FlashCopy V2 only) on page 30</a> .  When <b>FCINCREMENTAL</b> is specified, a relationship covering the entire volume is created. This relationship is maintained after the background copy operation is completed. When <b>FCINCREMENTAL</b> is specified, the following functionality becomes available. <ul style="list-style-type: none"> <li>The changed tracks since the last <b>COPY</b> command between the S-VOL and the T-VOL are tracked.</li> <li>When you re-execute the <b>COPY</b> command, only the changed tracks (differential data) are copied to the T-VOL.</li> </ul>

Parameter	Value	Description
		If you reverse the S-VOL and the T-VOL and execute the <code>COPY</code> command (Reverse Restore), only the differential data is copied to the resulting T-VOL.
FCINCREMENTALLAST	N/A	Deletes the relationship after completing the differential data copy operation.  When you re-execute the <code>COPY</code> command by specifying <code>FCINCREMENTALLAST</code> on a relationship created by specifying <code>FCINCREMENTAL</code> , only the differential data will be copied to the T-VOL. After the copy has completed, the relationship is deleted.  If you reverse the S-VOL and the T-VOL and execute the <code>COPY</code> command (Reverse Restore), only the differential data is copied to the resulting T-VOL. After Reverse Restore has completed, the relationship is deleted.
FCINCRVERIFY	N/A	Verifies the condition established when re-executing the <code>COPY</code> command.
	NOREVERSE	Only executes the copy operation when you specify the S-VOL and the T-VOL in the same way as when the relationship was created.
	REVERSE	Only executes the copy operation when you specify the S-VOL and the T-VOL in the opposite way as when the relationship was created.
DEBUG	FRMSG <sup>2</sup>	Specifies that you want to receive error description information if the Compatible FlashCopy® V2 operation fails. You can specify the amount of error information you want to receive.
FCTOPPRCPRIMARY	PRESMIRNONE	Specifies sharing the T-VOL with a TCz P-VOL or URz P-VOL. Specify this parameter when the Compatible FlashCopy® V2 T-VOL and the TCz or URz P-VOL share the same volume.
	PRESMIRREQ	Establishes the relationship using the Preserve Mirror FlashCopy® function. If the relationship cannot be established, the system rejects the command.
	PRESMIRRPREF	Establishes the relationship using the Preserve Mirror FlashCopy® function. If the relationship cannot be established, the copy operation is executed using the existing FlashCopy® to PPRC Primary Volume function.
FCSETGTOK <sup>3</sup>	FAILRELATION	Specifies that T-VOL can be a TSE-VOL.
<ol style="list-style-type: none"> <li>1. You cannot specify <code>COPYVOLID</code> and <code>DUMPCONDITIONINO</code> at the same time.</li> <li>2. For more information, see the IBM® documentation.</li> <li>3. Valid with Compatible FlashCopy® SE.</li> </ol>		

When you execute the `COPY FULL` command, DFSMSdss determines whether the selected volumes meet the requirements for use as Compatible FlashCopy® V2 volumes. DFSMSdss automatically determines if the copy is from the host or not. DFSMSdss processes the `COPY FULL` command in a few seconds and establishes the Compatible FlashCopy® V2 relationship as it completes the copy operation. The job completion is not reported.

The following example shows the DFSMSdss **COPY FULL** command for processing Compatible FlashCopy® V2 volume copy operations:

```
//COPYFULL JOB .....  
//*  
//INSTIMG EXEC PGM=ADRDSSU  
//SYSPRINT DD SYSOUT=*  
//SYSUDUMP DD SYSOUT=V,OUTLIM=3000  
//VOL1 DD UNIT=3390,VOL=SER=FCPY05,DISP=OLD  
//VOL2 DD UNIT=3390,VOL=SER=FCPY06,DISP=OLD  
//SYSIN DD *  
COPY FULL INDYNAM(FCPY05) OUTDYNAM(FCPY06) COPYVOLID  
/*
```

The following example shows the **COPY FULL** command with the **FCCGFREEZE** parameter:

```
//SYSPRINT DD SYSOUT=*  
//VOL1 DD UNIT=3390,VOL=SER=FCV200,DISP=OLD  
//VOL2 DD UNIT=3390,VOL=SER=FCV201,DISP=OLD  
//SYSIN DD*  
COPY FULL INDDNAME(VOL1) OUTDDNAME(VOL2)  
FASTREP(PREFERRED) FCCGFREEZE
```

The following example shows the use of the **CGCREATE** parameter:

```
//SYSPRINT DD SYSOUT=*  
//SYSIN DD*  
CGCREATE ACCESSVOLUME(FCV200) FCCGVERIFY(FCV200)
```

The following example shows the **COPY FULL** command with the **FCINCREMENTAL** parameter:

```
//SYSPRINT DD SYSOUT=*  
//VOL1 DD UNIT=3390,VOL=SER=FCV200,DISP=OLD  
//VOL2 DD UNIT=3390,VOL=SER=FCV201,DISP=OLD  
//SYSIN DD *  
COPY FULL INDDNAME(VOL1) OUTDDNAME(VOL2)  
FCINCREMENTAL
```

## Using ICKDSF to establish Compatible FlashCopy® V2 relationships by volume

The following table describes the parameters you can use with the ICKDSF **FLASHCPY ESTABLISH** command to establish Compatible FlashCopy® V2 relationships by volumes.

**Table 19 Parameters for the ICKDSF FLASHCPY ESTABLISH command**

Parameter	Value	Description
DDNAME DNAME	JCL statement	Specifies the JCL DD statement identifying the volume. If the host server OS is z/OS, this parameter or the UNITADDRESS parameter is required.
SYSNAME	SYSNAME	Specifies the SYSNAME in the ASSGN system control statement. If the host server OS is VSE, this parameter is required.
UNITADDRESS UNITADDR UNIT	Source device number	Specifies the device number (device address) of the S-VOL for the <b>FLASHCPY ESTABLISH</b> command. If the host server OS is z/OS, this parameter or the DDNAME parameter is required.
TARGETVOL TGTVOL	CU number LDEV number Target device number	Specifies the CU number, LDEV number, and device number (device address) of the T-VOL for the <b>FLASHCPY ESTABLISH</b> command. This parameter is required.
CHANGERECORDING CHANOERCD CHRCDD	YES	Establishes a relationship for the entire volume. The relationship will be maintained after the background copy operation completes, and if the S-VOL and the T-VOL are updated, the updated tracks will be managed as differential data.
	NO	Establishes a relationship for the entire volume. The relationship will be deleted after the background copy operation completes.  NO is the default setting.
INHIBITTARGETWRITES INHIBWRTS NOTGTWR	YES	Inhibits writes to the T-VOL. If the relationship is maintained after the background copy operation completes, you cannot access the T-VOL in write mode until the relationship is deleted or you execute a command to enable write access.
	NO	Do not inhibit writes to the T-VOL when the relationship is maintained after the background copy operation completes.  NO is the default setting.
MODE	COPY	Establishes a relationship for the entire volume, and executes the background copy operation.  COPY is the default setting.
	NOCOPY	Establishes a relationship for the entire volume. The background copy operation is not executed.
ONLINTGT ONTGT	YES	Establishes the relationship when the S-VOL is online.
	NO	Does not establish the relationship when the copy target is online.  NO is the default setting.
RESTORE	N/A	If the S-VOL or the T-VOL of the relationship established by specifying YES for CHANGERECORDING is updated, only the data that has been changed on the S-VOL or T-VOL is copied. If you specify YES for CHANGERECORDING and

Parameter	Value	Description
		<p>you reverse the S-VOL or T-VOL, Reverse Restore is executed, and only the data that has been changed on the S-VOL or T-VOL is copied.</p> <p>The relationship will be maintained after the copy operation completes if you specify YES for CHANGERECDING. If you specify NO or nothing for INCREMENTAL CHANGERECDING, the relationship will be withdrawn after the copy operation completes.</p>
FASTREVERSERESTORE FASTREVREST	N/A	<p>Specifies that the S-VOL and T-VOL of the relationship are to be reversed.</p> <ul style="list-style-type: none"> <li>If you specify YES for CHANGERECDING, only the data that has been changed on the S-VOL or T-VOL is copied.</li> <li>If you specify NO for CHANGERECDING or specify nothing, only the data that has been copied from the S-VOL to the T-VOL is copied.</li> <li>If you specify YES for CHANGERECDING, the relationship will be maintained after the copy operation completes. If you specify NO or nothing for CHANGERECDING, the relationship will be withdrawn after the copy operation completes.</li> </ul>
TGTCANCOMEONLINE TGTONLINE	YES	<p>Enables the T-VOL to be set online after the relationship is established.</p> <p>YES is the default setting.</p>
	NO	<p>Prevents the T-VOL from being set online until the relationship is deleted.</p>
TGTOKASPPRCPRIM	YES	<p>Specify this parameter when the Compatible FlashCopy® V2 T-VOL and the TCz P-VOL or URz P-VOL share a volume.</p>
	NO	<p>Specify this parameter when the Compatible FlashCopy® V2 T-VOL and the TCz P-VOL or URz P-VOL do <i>not</i> share a volume.</p> <p>NO is the default setting.</p>
SOURCEVOL SRCVOL	CU number LDEV number Source device number	<p>Specifies the CU number, the LDEV number, or the device number of the S-VOL when you use the Remote FlashCopy® function.</p>
PRESERVEMIRROR PRESMIR	REQUIRED	<p>Establishes the relationship using the Preserve Mirror FlashCopy® function. If the relationship cannot be established, the system rejects the command. You must also specify TGTOKASPPRCPRIM(YES).</p>
	PREFERRED	<p>Establishes the relationship using the Preserve Mirror FlashCopy® function. If the relationship cannot be established, the copy operation is executed using the existing FlashCopy® to PPRC Primary Volume function. You must also specify TGTOKASPPRCPRIM(YES).</p>
	NO	<p>Establishes the relationship without using the Preserve Mirror FlashCopy® function.</p> <p>NO is the default setting.</p>

Parameter	Value	Description
SETGTOK*	YES	Specifies that the T-VOL can be a TSE-VOL.
	NO	Specifies that the T-VOL cannot be a TSE-VOL.
*Valid in Compatible FlashCopy® SE.		

To create a Compatible FlashCopy® V2 relationship using the ICKDSF **FLASHCPY ESTABLISH** command:

### Procedure

1. Set the T-VOL offline.  
If the ONLINTGT parameter is set to YES, the T-VOL will be set offline automatically when creating the relationship.
2. Specify the S-VOL by using the DDNAME parameter to reference a JCL DD statement, or by using the UNITADDRESS parameter.
3. Specify the CU number, LDEV number, and device number of the T-VOL for the TARGETVOL parameter.
4. Execute the **FLASHCPY ESTABLISH** command, for example:  
FLASHCPY ESTABLISH UNIT(X'7000') TARGETVOL(X'00',X'01',7001)  
CHANGERECORDING(YES) ONLINTGT(YES)

## Compatible FlashCopy® V2 Reverse Restore using the ICKDSF **FLASHCPY ESTABLISH** command

To execute a Compatible FlashCopy® V2 Reverse Restore operation, you use a relationship that was created with the Incremental FlashCopy® function, and reverse the S-VOL and the T-VOL (Reverse Restore).

To use Reverse Restore with an existing Compatible FlashCopy® V2 relationship:

### Procedure

1. Execute the **FLASHCPY ESTABLISH** with the RESTORE parameter to reverse the direction of the relationship. For example:  
FLASHCPY ESTABLISH UNIT(X'7001') TARGETVOL(X'00',X'00',7000)  
RESTORE

If the S-VOL is updated before you perform the Reverse Restore operation, only the data that has changed on the S-VOL (differential data) is copied to the T-VOL. When the T-VOL is updated, before the Reverse Restore operation is performed, only the data that has changed on the T-VOL is copied from the S-VOL.

Set the CHANGERECORDING parameter to YES to maintain the relationship after the copy process is completed and to continue tracking differential data between the S-VOL and the T-VOL. If you do not specify

the CHANGERECORDING parameter, the relationship is deleted after the copy operation is completed.

## Compatible FlashCopy® V2 Fast Reverse Restore using the ICKDSF FLASHCPY ESTABLISH command

You can copy the differential data of an existing Compatible FlashCopy® V2 relationship by using the Fast Reverse Restore function to reverse the S-VOL and the T-VOL.

### Procedure

1. Execute the **FLASHCPY ESTABLISH** command with the **FASTREVREST** parameter to reverse the S-VOL and T-VOL to perform the Fast Reverse Restore function. For example:

```
FLASHCPY ESTABLISH UNIT(X'7001') TARGETVOL(X'00',X'00',7000)
FASTREVREST
```

When you perform the Fast Reverse Restore operation, the S-VOL becomes the T-VOL, and the T-VOL becomes the S-VOL. The data of the S-VOL is copied to the T-VOL as follows:

- If the S-VOL is updated before you perform Fast Reverse Restore, only the updated data is copied to the T-VOL.
- If the T-VOL is updated before you perform Fast Reverse Restore, only the updated data is copied from the S-VOL to the T-VOL.

## Compatible FlashCopy® V2 Incremental Restore using the ICKDSF FLASHCPY ESTABLISH command

You can perform an incremental restore on an existing Compatible FlashCopy® V2 relationship using the Restore function.

### Procedure

1. Execute the **FLASHCPY ESTABLISH** command with the **RESTORE** parameter using an existing Compatible FlashCopy® V2 relationship. For example:

```
FLASHCPY ESTABLISH UNIT(X'7000') TARGETVOL(X'00',X'01',7001)
RESTORE
```

When the S-VOL is updated, only the data that has changed on the S-VOL (differential data) will be copied to the T-VOL. When the T-VOL is updated, only the data that has changed on the T-VOL will be copied from the S-VOL.

Set the CHANGERECORDING parameter to YES to maintain the relationship after the copy process is completed and to maintain tracking differential data between the S-VOL and the T-VOL. If you do not specify the CHANGERECORDING parameter, the relationship will be deleted after the copy operation is completed.

## Using the ANTRQST macro to establish Compatible FlashCopy® V2 relationships by volume

The following table describes the parameters that you can use with the **ANTRQST** macro to establish Compatible FlashCopy® V2 relationships by volume.

**Table 20 ANTRQST macro command parameters (REQUEST=FCESTABLISH)**

Parameter	Value	Description
SDEVN	Source device number	Specifies the device number (device address) of the S-VOL on which you want to perform the <b>FCESTABLISH</b> command.
TDEVN	Target device number	Specifies the device number (device address) of the T-VOL on which you want to perform the <b>FCESTABLISH</b> command.
INCREMENTAL	YES	Establishes a relationship including all tracks in the volume. If you specify YES for this parameter and COPY for the MODE parameter, the relationship is maintained after the background copy operation completes, and the differential data between the S-VOL and the T-VOL is maintained. As long as the relationship is maintained, you cannot update the T-VOL.  When you execute the ANTRQST macro with the INCREMENTAL parameter, the differential data between the S-VOL and the T-VOL is copied.
	NO	The relationship will be deleted after background copying completes.  NO is the default setting.
	YTW	The relationship remains in effect after the background copy operation completes. Data can be written to the T-VOL. Subsequent changes are tracked so that future operations are performed incrementally. This relationship continues until explicitly ended with a Withdraw request.  <b>Note:</b> The target volume is writable while the incremental relationship is active. Any writes to the target during this period are overwritten if a subsequent incremental copy is executed, keeping the target an exact copy of the source. If the relationship is reversed, the changes made to the target are reflected to the source.
TGTPPRIM	YES	Specifies using the Compatible FlashCopy® V2 T-VOL as a TCz P-VOL or a URz P-VOL.
	NO	Specifies that the Compatible FlashCopy® V2 T-VOL is not sharing a volume with a TCz P-VOL or a URz P-VOL.  NO is the default setting.
RETINFO	Return value	Obtains the return code and the reason code for the execution results. For information about the codes, see the <i>IBM® z/OS® MVS System Messages, Vol 1 (ABA-AOM)</i> , or the ANTRQSTL macro code.
MODE	COPY	Copy all of the data in the source volume copy range specified in SDEVN in the background to the target volume specified by

Parameter	Value	Description
		TDEVN. The relationship ends automatically, and the Compatible FlashCopy® V2 relationship is deleted when all of the data is copied.  COPY is the default setting.
	NOCOPY	Do not copy data in the background. The relationship does not end automatically even when all of the data is copied. To withdraw the relationship, use the <b>FCWITHDR</b> command. In the following cases, the data subject to read/write processing is copied from the source to the target before Compatible FlashCopy® V2 read/write processing starts. <ul style="list-style-type: none"> <li>When there is access to write a track not already copied on the source volume within the extent.</li> <li>When there is access to write a track not already copied on the target volume within the extent.</li> <li>When there is access to read data from the copy target from within the extent.</li> </ul>
	NO2CPY	A relationship created using NOCOPY mode is changed to COPY mode and a background copy operation is started. When all of the data is copied, the relationship is released automatically.
ONLINTGT	YES	Do not check the path group. The relationship is established even when the copy target is online.
	NO	Check the path group. The relationship is not established when the copy target is online.  NO is the default setting.
ACTION	FREEZE	Suspends the write operations from the host to S-VOLs. To resume the write operation, you need to issue the <b>FCWITHDRAW</b> command with the ACTION parameter. If a timeout occurs, the write operation may be resumed even when you do not issue the <b>FCWITHDRAW</b> command.  The default setting for the timeout is 120 seconds (two minutes), but you can change it.
	FRR	Reverse the S-VOL and T-VOL of an existing relationship. <ul style="list-style-type: none"> <li>If you specify YES for INCREMENTAL, only the data that has been changed on the S-VOL or T-VOL of the established relationship is copied.</li> <li>If you specify NO for INCREMENTAL, or specify nothing, only the data that has been changed on the S-VOL or T-VOL of the established relationship is copied.</li> </ul>
TGTUCB	YES	Specifies the device number (device address) of the T-VOL on which you want to perform the <b>FCESTABLISH</b> command. To specify this number, use the TDEVN parameter.  YES is the default setting.
	NO	Specifies the serial number, CU number, and LDEV number of the T-VOL on which you want to execute the <b>FCESTABLISH</b> command. To specify this number, use the TGTSERIAL, TGTLSS, TGTDVC parameters instead of TDEVN.
PRESMIR	NO	Establishes the relationship without using the Preserve Mirror FlashCopy® function.  NO is the default setting.

Parameter	Value	Description
	REQ	Establishes the relationship using the Preserve Mirror FlashCopy® function. If the relationship cannot be established, the system rejects the command. TGTPPRIM=YES must be specified at the same time.
	PREF	Establishes the relationship using the Preserve Mirror FlashCopy® function. If the relationship cannot be established, the copy operation is executed using the existing FlashCopy® to PPRC Primary Volume function. TGTPPRIM=YES must be specified at the same time.
TGTSERIAL	Serial number of the storage system containing the T-VOL	Specifies the serial number of the storage system containing the T-VOL on which you want to execute the <b>FCESTABLISH</b> command. Use this parameter when the TGTUCB parameter is set to NO or the REMOTE parameter is set to YES.
TGTLSS	T-VOL CU number	Specifies the CU number of the T-VOL on which you want to perform the <b>FCESTABLISH</b> command. Use this parameter when the TGTUCB parameter is set to NO or the REMOTE parameter is set to YES.
TGTDVC	T-VOL LDEV number	Specifies the LDEV number of the T-VOL on which you want to execute the <b>FCESTABLISH</b> command. Use this parameter when the TGTUCB parameter is set to NO, or the REMOTE parameter is set to YES.
REMOTE	YES	Use the Remote FlashCopy® function to establish a relationship.
	NO	You do not use the Remote FlashCopy® function. NO is the default setting.
DEVN	TCz source device number	Specifies the TCz source device number (device address). Use this parameter when REMOTE is set to YES.
SRCSERIAL	Serial number of the storage system containing the S-VOL	Specifies the serial number of the storage system containing the S-VOL on which you want to execute the <b>FCESTABLISH</b> command. Use this parameter when REMOTE is set to YES.
SRCLSS	S-VOL CU number	Specifies the CU number of the S-VOL on which you want to perform the <b>FCESTABLISH</b> command. Use this parameter when REMOTE is set to YES.
SRCDVC	S-VOL LDEV number	Specifies the LDEV number of the S-VOL on which you want to execute the <b>FCESTABLISH</b> command. Use this parameter when REMOTE is set to YES.
SSID	SSID	Specifies the SSID of the CU on which to establish the FlashCopy® relationship. Use this parameter when REMOTE is set to YES.
SETGTOK*	YES	Specifies that the T-VOL can be a TSE-VOL.
	NO	Specifies that the T-VOL cannot be a TSE-VOL.
*Valid in Compatible FlashCopy® SE.		

## Establishing Compatible FlashCopy® V2 relationships by extent

You can use the following host interfaces to establish Compatible FlashCopy® V2 relationships by extent:

- PPRC TSO
- DFSMSdss
- ANTQRST macro

## Using TSO to establish Compatible FlashCopy® V2 relationships by extent

The following table describes the parameters used to establish Compatible FlashCopy® V2 relationships by extent with the **FCESTABL** command.

**Table 21 Parameters for using the FCESTABL command to establish Compatible FlashCopy V2 relationships by extent)**

Parameter	Value	Description
EXTENTS	Extents (copy range)	Specifies the extent (copy range) by setting the same starting and ending addresses of the source and target with CCHH (cylinder and head numbers). From the copy source, the specified data is copied to the same offset position on the copy target. Up to 32 extents can be specified. When EXTENTS is not specified, the data on all of the tracks is copied.
XTNTLST	Extents (copy range)	Specifies the extent (copy range) by setting the starting and ending addresses of the source, and the starting and ending addresses of the target with CCHH (cylinder and head numbers). From the copy source, the specified data is copied to a different offset position on the copy target. Up to 32 extents can be specified. When XTNTLST is not specified, the data on all of the tracks is copied.
XXTNTLST	Extents (copy range)	Specifies the extent (copy range) by setting the starting and ending addresses of the source, and the starting and ending addresses of the target with cccccch (cylinder and head numbers), when either of both the copy source and target exceed 65,520 cylinders. From the copy source, the specified data is copied to a different offset position on the copy target. Up to 32 extents can be specified. When XXTNTLST is not specified, the data on all of the tracks is copied.

If you specify the XTNTLST or XXTNTLST parameter, the size of the copy source extent and the copy target extent must be the same.

When you execute the **FCESTABL** command with the EXTENTS parameter, only the specified source extents are copied from the source to the target. The source extents are specified by SDEVN and the target extents are specified by TDEVN. The following figure shows an example of copying only Dataset 2 from the S-VOL to the T-VOL. If you do not specify the EXTENTS parameter, the entire source volume is copied to the target volume.

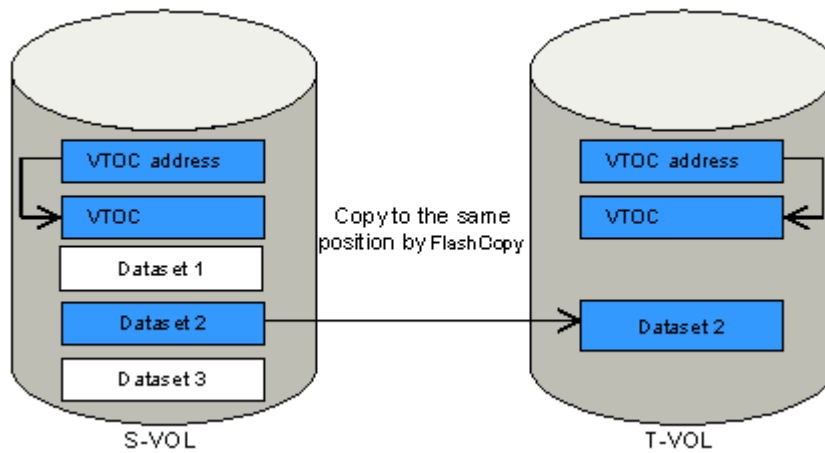

**Figure 24 Copying datasets using the `FCESTABL` command with the `EXTENTS` parameter (Compatible FlashCopy® V2)**

When you execute the `FCESTABL` command with the `XTNTLTS` or `XXTNTLST` parameter, the specified source extents are copied to the specified target extents. Starting and ending addresses are specified by cylinder and head and do not have to match in the source and target volumes. The following figure shows an example of copying Dataset 2 from the S-VOL to a different position on the T-VOL.

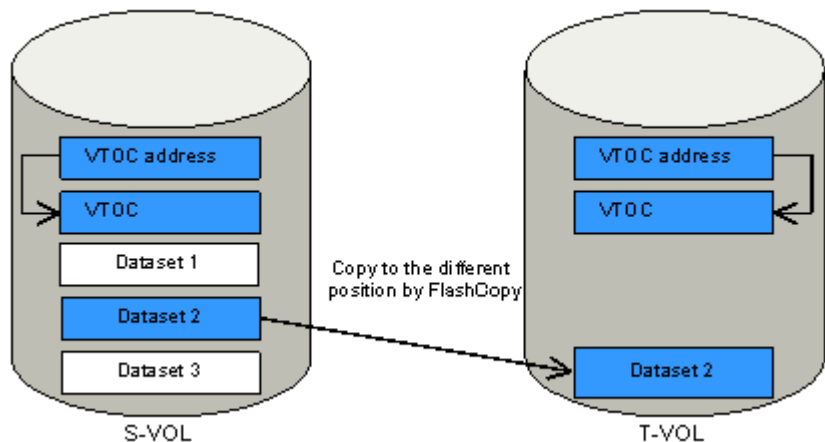

**Figure 25 Copying datasets using the `FCESTABL` command with the `XTNTLST` or `XXTNTLST` parameter (Compatible FlashCopy® V2)**

When you establish a Compatible FlashCopy® V2 dataset relationship per extent for a volume with `CATALOG`, you trigger a write operation from the host to both the VTOC and `CATALOG` (the volume table of contents and dataset attributes and the data set locations).

To perform dataset copying using the `FCESTABL` command:

## Procedure

1. Use the VTOC list stored in the S-VOL to check the VTOC INDEX and the position of the extent (cylinder number, header number, and size) used for the dataset copy operation.
2. Create the copy target dataset on the T-VOL.
3. Obtain the VTOC list stored in the T-VOL.
4. Set the T-VOL offline.
5. Execute the **FCESTABL** command with the XTNTLST or XXTNTLST parameter.

Use the XTNTLST or XXTNTLST parameter to specify the extent position information for the source and target extents. If there are multiple extents, you need to specify the position information for each extent.

Use the XTNTLST or XXTNTLST parameter as follows:

- Specify multiple copy target datasets to be copied simultaneously from a single copy source dataset.
  - Specify the simultaneous execution of volume copying and dataset copying from a single source volume.
  - Specify multiple source datasets that are overlapping or are part of another dataset. You can specify a maximum of 16 extents per dataset.
  - Do not specify multiple target datasets that are overlapping.
  - Specify source and target datasets that reside at one position on the S-VOL and at a different position on the T-VOL.
  - Specify source and target datasets that are in the same volume, provided that they do not overlap.
6. If the T-VOL was set offline in step 4, set it online.  
You can skip this step if the ONLINTGT parameter of the **FCESTABL** command is set to YES.  
You can only execute the **FCESTABL** command once for each Compatible FlashCopy® V2 relationship.

An example of the **FCESTABL** command follows. In this example, the **FCESTABL** command specifies the following:

```
FCESTABL SDEVN(X'4202') TDEVN(X'4203') MODE(NOCOPY)
          XTNTLST(X'01000004' X'0357000A' X'13000001' X'15570007',
                 X'02AC0006' X'02FF000C' X'18A00000' X'18F30006')
```

- The data on the extent starting from CCHH '01000004' and ending at CCHH '0357000A' on source device number 4202 is to be copied to the extent starting from CCHH '13000001' and ending at CCHH '15570007' on target device number 4203.
- The data on the extent starting from CCHH '02AC0006' and ending at CCHH '02FF000C' on source device number 4202 is to be copied to the extent starting from CCHH '18A00000' and ending at CCHH '18F30006' on target device number 4203 (the copy operation mode is set to NOCOPY).

Example of **FCESTABL** command (Compatible FlashCopy® V2 / **XTNTLST** and **NOCOPY** are specified):

## Using DFSMSdss to establish Compatible FlashCopy® V2 relationships by extent

You can use DFSMSdss **COPY DS** for Compatible FlashCopy® V2 dataset copy operations. See [Table 18 Parameters for DFSMSdss, Volume copying on page 79](#) for **COPY DS** command parameter descriptions.

When you execute the **COPY DS** command, DFSMSdss determines whether the selected volumes meet the requirements for use as Compatible FlashCopy® V2 volumes, and automatically determines if the copy is from the host or not. DFSMSdss processes the **COPY DS** command and establishes the Compatible FlashCopy® V2 relationship as it completes the processing. The job completion is not reported.

The following example shows use of the DFSMSdss **COPY DS** command to perform Compatible FlashCopy® V2 dataset copy operations. In this example, all datasets starting with SAM020 on volume FCPY05 are copied to volume FCPY06.

```
//DSSCOPY JOB
//*
//INSTIMG EXEC PGM=ADRDSU
//SYSPRINT DD SYSOUT=*
//SYSUDUMP DD SYSOUT=V,OUTLIM=3000
//VOL1 DD UNIT=3390,VOL=SER=FCPY05,DISP=OLD
//VOL2 DD UNIT=3390,VOL=SER=FCPY06,DISP=OLD
//SYSIN DD *
COPY DS(INCL(SAM020.**)) INDDNAME(FCPY05)
OUTDDNAME(FCPY06) FASTREPLICATION(PREFERRED) -
FCNOCOPY DEBUG (FRMSG(DETAILED))
/*
```

You can establish up to 16 relationships simultaneously from a single copy source extent.

## Using ANTRQST macro to establish Compatible FlashCopy® V2 relationships by extent

The following **ANTRQST** macro parameters can be used to establish Compatible FlashCopy® V2 relationships by extent.

**Table 22 ANTRQST macro command parameters  
(REQUEST=FCESTABLISH)**

Parameter	Value	Description
SRCEXTENTS	Copy source extent (copy range)	Specifies the copy source extent (copy range) by setting the starting and ending addresses of the source using CCHH format (cylinder and head numbers). Up to 32 extents can be specified. When SRCEXTENTS is not specified, the data on all of the tracks is copied. You cannot specify this parameter if you specify YES for the INCREMENTAL parameter.
TGTEXTENTS	Copy target extent (copy range)	Specifies the copy target extent (copy range) by setting the starting and ending addresses of the target using CCHH format (cylinder and head numbers). Up to 32 extents can be specified. When TGTEXTENTS is not specified, the data on all of the tracks is copied. You cannot specify this parameter if you specify YES for the INCREMENTAL parameter.

## Using z/VM CP to establish Compatible FlashCopy® V2 relationships

The following table shows the z/VM CP commands that you can use to establish Compatible FlashCopy® V2 relationships. For details about the z/VM CP commands, see the *IBM® z/VM CP Commands and Utilities Reference* for the z/VM version you are using.

**Table 23 z/VM CP commands for establishing Compatible FlashCopy V2 relationships**

CP command	Description
FLASHCOPY	Establishes the relationship in COPY mode. Cancels the relationship after the background copy operation completes.
FLASHCOPY ESTABLISH	Creates the persistent relationship. Does not cancel the relationship after the copy operation completes. (The Incremental FlashCopy® function, NOCOPY mode, and the S-VOL write-protect specification are available.).
FLASHCOPY BACKGNDCOPY	Starts the background copy of the relationship created in NOCOPY mode. Does not cancel the relationship after the background copy operation completes.
FLASHCOPY RESYNC	Performs the restoration (resync) of the relationship created by the Incremental FlashCopy® function. Does not cancel the relationship after the restoration completes.
FLASHCOPY TGTWRITE	Cancels the S-VOL write-protect for the relationship established by the S-VOL write-protect specification. Does not cancel the relationship.

## Using z/VM FlashCopy® to establish relationships

The following table shows the parameters that can be used with the z/VM **FLASHCOPY** to establish relationships.

**Table 24 Parameters available with FLASHCOPY command**

Parameter	Value	Description
vdev1	Primary device number	Specifies the virtual device number of the copy source (device address or mini disk number).
scyl1	Starting cylinder of source	Specifies the starting cylinder of the copy source. Specify 0 if the entire volume is the target.
ecyl1	Ending cylinder of source	Specifies the ending cylinder of the copy source. Specify END if the entire volume is the target.
vdev2	Secondary device number	Specifies the virtual device number of the copy destination (device address or mini disk number).
scyl2	Starting cylinder of target	Specifies the starting cylinder of the copy destination. Specify 0 if the entire volume is the target.
ecyl2	Ending cylinder of target	Specifies the ending cylinder of the copy destination. Specify END if the entire volume is the target.

An example of the **z/VM FLASHCOPY** command follows. In this example, cylinders 0 to 99 from virtual device 10 are copied to virtual device 20 in COPY mode. The relationship is canceled after the copy operation completes.

```
FLASHCOPY 10 0 END 20 0 END
Command complete: FLASHCOPY 0010 0 99 TO 0020 0 99
```



**Note:** The **FLASHCOPY** command cancels the relationship after the copy completes.

## Using z/VM FLASHCOPY ESTABLISH to establish relationships

The **FLASHCOPY ESTABLISH** command does not cancel the relationship after the copy operation completes. The following table shows the parameters are available when establishing relationships by using the **FLASHCOPY ESTABLISH** command.

**Table 25 Parameters for the FLASHCOPY ESTABLISH command**

Parameter	Value	Description
SOURCE	Primary device number, Starting cylinder of source, Ending cylinder of source	Specifies the virtual device number (device address or mini disk number), the starting cylinder, and the ending cylinder of the copy source.
TARGET	Secondary device number, Starting cylinder of target, Ending cylinder of target	Specifies the virtual device number (device address or mini disk number), the starting cylinder, and the ending cylinder of the copy destination.
CHGRECORD	-	Establishes a relationship whose target is the entire virtual volume. If the S-VOL and the T-VOL are updated, the data that has been changed is managed as differential data.
NOTGTWRITE	-	Write to the S-VOL is not allowed until the <b>FLASHCOPY TGTWRITE</b> is executed.

Parameter	Value	Description
REVERSIBLE	-	Establishes a relationship whose target is the entire virtual volume. If the S-VOL and the T-VOL are updated, the data that has been changed on the S-VOL or T-VOL is managed as differential data, and write to the T-VOL is not allowed until the <b>FLASHCOPY TGTWRITE</b> command is executed.
NOCOPY	-	Does not perform the background copy when establishing the relationship.
FAILNOSPACE	-	When the T-VOL is a TSE-VOL and the pool becomes full, the state of the relationship will change to failed state. For details about failed state, see <a href="#">Managing failed states on page 141</a> .  When the T-VOL is a TSE-VOL, this parameter is set by default.
NOSETARGET	-	This parameter can be set when the T-VOL is not a TSE-VOL. If this parameter is specified when the T-VOL is a TSE-VOL, creating relationships will fail.

See the *IBM® z/VM CP Commands and Utilities* document for your version of z/VM for more information about the parameters.

An example of the **FLASHCOPY ESTABLISH** command follows. In this example, cylinders 0 to 99 are copied from device 10 to device 20 in COPY mode. The relationship remains after the completion of the copy operation.

```
FLASHCOPY ESTABLISH SOURCE 10 0-END TARGET 20 0-END
Command complete: FLASHCOPY 0010 0 99 TO 0020 0 9
```

To cancel the relationship after the copy completes, use the **FLASHCOPY WITHDRAW** command. For more information on the **FLASHCOPY WITHDRAW** command, see [Using z/VM CP FLASHCOPY WITHDRAW to release Compatible FlashCopy V2 relationships on page 132](#).

If the relationship is established using the **FLASHCOPY ESTABLISH** command, 0010 (background copy operation started) might be displayed as the reference code in the History window of Device Manager - Storage Navigator, regardless of which **FLASHCOPY ESTABLISH** parameter is specified. When you specify NOCOPY mode, code 0023 might be displayed.

## Using z/VM FLASHCOPY BACKGNDCOPY to start the background copy operation

The **FLASHCOPY BACKGNDCOPY** command starts up background copying of the relationship established in NOCOPY mode. The relationship remains after background copying is completed.

**Table 26 FLASHCOPY BACKGNDCOPY command parameters**

Parameter	Value	Description
SOURCE	Primary device number, Starting cylinder of source extent, Ending cylinder of source extent	Specifies the virtual device number (device address or mini disk number), the starting cylinder, and the ending cylinder of the copy source extent.

## Using z/VM FLASHCOPY RESYNC to re-establish relationships

Use the **FLASHCOPY RESYNC** command to re-establish the relationship that was originally established by using the **CHGRECORD** or **REVERSIBLE** parameter.

The following table shows the parameters that are available with the **FLASHCOPY RESYNC** command.

**Table 27 FLASHCOPY RESYNC command parameters**

Parameter	Value	Description
SOURCE	Primary device number Starting cylinder of source extent Ending cylinder of source extent	Specifies the virtual device number (device address or mini disk number), the starting cylinder, and the ending cylinder of the copy source extent.
TARGET	Secondary device number Starting cylinder of target Ending cylinder of target	Specifies the virtual device number (device address or mini disk number), the starting cylinder, and the ending cylinder of the copy target extent.

If the S-VOL is updated, the data that has been changed on the S-VOL (differential data) is copied to the T-VOL. If the T-VOL is updated, the data that has been changed on the T-VOL is overwritten by the corresponding part of the data in the S-VOL.

The Reverse Restore function operates if the **FLASHCOPY RESYNC** command is re-established by reversing the S-VOL and the T-VOL of the relationship established by specifying the **INCREMENTAL** parameter.

The following example shows how you can re-establish relationships using the **FLASHCOPY RESYNC** command. The **FLASHCOPY ESTABLISH** command establishes a relationship from virtual device number 30 to virtual device number 40 and manages differential data. The **FLASHCOPY RESYNC** command copies only the updated data from virtual device number 30 to virtual device number 40.

```
FLASHCOPY ESTABLISH SOURCE 30 0-END TARGET 40 0-END CHGRECORD
REVERSIBLE
Command complete: FLASHCOPY 0030 0 END TO 0040 0 END
FLASHCOPY RESYNC SOURCE 30 0-END TARGET 40 0-END RESYNC COMPLETED
```

## Using the z/VM FLASHCOPY TGTWRITE command to remove write-protection from a T-VOL

The following table describes the parameter that is available with the **FLASHCOPY TGTWRITE** command.

**Table 28 FLASHCOPY TGTWRITE command parameters**

Parameter	Value	Description
TARGET	Target (secondary) virtual device number Starting cylinder of target extent Ending cylinder of target extent	Specifies the virtual device number (device address or mini disk number), the starting cylinder, and the ending cylinder of the copy target extent.

## Suspending write operations to S-VOLs when establishing Compatible FlashCopy® V2 relationships

When using **FCESTABL** to establish Compatible FlashCopy® V2 relationships, you can suspend write operations to S-VOLs. Suspending write operations to S-VOLS helps to keep data consistent.

**Table 29 ACTION parameter to the FCESTABL command to suspend write operations to S-VOLs**

Parameter	Value	Description
ACTION	FREEZE	Suspend the write operations from the host to S-VOLs. If you establish a relationship specifying extents, the ACTION parameter suspends the write operation to the whole volume.

The following example shows how to use the **FCESTABL** command with the **ACTION** parameter to suspend write operations on an S-VOL when you establish a Compatible FlashCopy® V2 relationship.

```
FCESTABL SDEVN(X'4202') TDEVN(X'4203') ACTION(FREEZE)
```

In this example, the **FCESTABL** command establishes a relationship between volume (device) number 4202 and volume number 4203, and at the same time suspends write operations from the host to the source device, volume 4202.

To resume write operations to S-VOLs, you need to issue the **FCWITHDR** command with the **ACTION** parameter specified.

If a timeout occurs, write operations might be resumed even if you did not issue the **FCWITHDR** command. The default setting for the timeout is 120 seconds.



**Caution:** The state change pending (SCP) time for Compatible FlashCopy® V2 and TrueCopy for Mainframe is the same. Therefore, when you change the SCP time for Compatible FlashCopy® V2, you must specify a value that is appropriate for TrueCopy for Mainframe. For information about the SCP time for TrueCopy for Mainframe, see the *Hitachi TrueCopy® for Mainframe User Guide*.

---

## Changing the SCP time

SCP time is the interval that I/O from the host is suspended.

### Before you begin

- You must have the Storage Administrator (Local Copy) and Storage Administrator (Remote Copy) role.

### Procedure

1. Open the **Edit SCP Time** window.  
Click **Actions > Local Replication > Edit SCP Time**.
2. In the **Edit SCP Time** window, select the CU for which you want to change the SCP time and click **Change SCP Time**.
3. In the **Change SCP Time** window, enter the SCP time you want to set and click **OK**.
4. Click **Finish**.
5. In the **Confirm** window, enter a **Task Name** and click **Apply**.  
If you selected **Go to tasks window for status**, the **Task** window opens when the task begins.

### Related concepts

- [Edit SCP Time wizard](#) on page 174

## Viewing details of Compatible FlashCopy® V2 relationships

To view the details of Compatible FlashCopy® V2 relationships, use any of the following commands:

- PPRC TSO **FCQUERY**
- ICKDSF **FLASHCPY QUERY**
- ANTRQST macro **REQUEST = FCQUERY**
- z/VM CP **QUERY VIRTUAL FLASHCOPY**

## Using TSO FCQUERY to view Compatible FlashCopy® V2 relationship details

The following table shows the **FCQUERY** parameters you can use to view details of Compatible FlashCopy® V2 relationships.

**Table 30 FCQUERY command parameters**

Parameter	Value	Description
DEVN	Device number	Specify the number (device address) of the Compatible FlashCopy® V2 volume whose details you want to display.
REMOTE	YES	The target volume of this request is on a storage system that is remote to the host issuing the command. When REMOTE(YES) is used, the DEVN parameter must specify a PPRC primary device in a storage system that is attached to the host issuing the request, and the FlashCopy® S-VOL must be the PPRC S-VOL for the specified DEVN.
	NO	The target volume of this request is on a storage system that is attached (local) to the host issuing the command.  NO is the default setting.
QRYSSID	SSID	Specifies the SSID of the CU on which the FlashCopy® relationship was established.  Use this parameter when REMOTE is YES.
QRYDVC	Serial number of the remote DKC  CU number  LDEV number	Specifies the serial number of the remote DKC, the CU number, and the LDEV number of the volume that is the target of the status query command.  Use this parameter when REMOTE is YES.
SHOWRELS	ALL	Displays detailed relationship information.
	NO	Does not display detailed information about relationships.  NO is the default setting.
	Integer between 1 and 9999	Displays the same information as for ALL. However, detailed information is shown only for the specified number of relationships.
STARTADDR	CCHH number	Specifies the CCHH number of the starting address. Use this parameter when the relationship number is specified in the SHOWRELS parameter.

You can use the **FCQUERY** command to display information such as the attributes for devices specified by DEVN and the number of Compatible FlashCopy® V2 relationships established with the specified devices.

An example of the **FCQUERY** command follows. This command requests that information about device 4202 be displayed.

```
FCQUERY DEVN(4202)
```

The following example shows the output of this **FCQUERY** command.

```
ANTF0090I FCQUERY Formatted
DEVN SSID LSS CCA CU SERIAL ACT MAX XC PC CC RV SE SEQNUM
```

The following table shows the information displayed by the **FCQUERY** command.

**Table 31 FCQUERY command output**

Item	Value	Description
DEVN	Device number	Device number recognized by the host.
SSID	Storage system ID	Storage subsystem ID.
LSS	CU number	CU number.
CCA	LDEV number in CU	LDEV number in the CU.
CU	DKC emulation type	DKC emulation type.
SERIAL	Serial number	Serial number.
ACT	Number of active relationships	Number of active Compatible FlashCopy® V2 and Compatible FlashCopy® SE relationships. For details, see the figure and description about the number of the relationships that follow this table.
MAX	Maximum number of pairs and relationships	Maximum number of pairs and relationships that can be created with the device specified by DEVN.
XC	S	Volume status specified by DEVN is one of the following: <ul style="list-style-type: none"> <li>P-VOL of the XRC pair.</li> <li>SIz S-VOL using the ATTIME Suspend function (online)<sup>1</sup>.</li> <li>P-VOL of the TCz pair (Timer Type is SYSTEM or NONE, and the pair status is Duplex or Pending).</li> <li>P-VOL of the URz pair (Timer Type is SYSTEM or NONE, and the pair status is Duplex or Pending).</li> </ul>
	N	Volume specified by DEVN is not in the status described above, or the volume is not used.
PC	P	Volume specified by DEVN is currently used as the P-VOL of an SIz or TCz pair.
	S	Volume specified by DEVN is currently used as an SIz or TCz S-VOL.  When the volume is used as an SIz or TCz S-VOL, N is displayed if one of the following conditions is satisfied: <ul style="list-style-type: none"> <li>For TCz, the pair is suspended and system option mode 20 is ON. For details about system option mode 20, see the <i>Hitachi TrueCopy® for Mainframe User Guide</i>.</li> <li>For TCz, the pair is suspended and secondary volume Read/Write is enabled.</li> <li>For TCz, the pair is being swapped (Swapping).</li> <li>For SIz, the pair is in Split or V-Split status.</li> </ul> If YES is specified for the REMOTE parameter, S is always displayed regardless of the above conditions.
	N	Volume specified by DEVN is currently not used by SIz or TCz.  In some cases N might be displayed when the volume specified by DEVN is used as an SIz or TCz S-VOL. See the description for the PC S value.

Item	Value		Description
CC	S		Volume specified by DEVN is currently used as the source volume of a Concurrent Copy pair.
	N		Volume specified by DEVN is currently used as the T-VOL of the Concurrent Copy pair, or not used for Concurrent Copy.
RV	N		Displays whether the volume specified by DEVN is Revertible or not. However, since Compatible FlashCopy® V2 does not support this function, N will always be displayed for this item. For details about Revertible, see the <i>IBM® PPRC</i> document.
SE <sup>2</sup>	S	Y	The volumes specified by DEVN are TSE-VOLs.
		N	The volumes specified by DEVN are not TSE-VOLs.
	E	N	The volumes specified by DEVN are not source volumes of relationships containing TSE-VOLs.
		Y	The volumes specified by DEVN are source volumes of relationships containing TSE-VOLs.
		F	The volumes specified by DEVN are source volumes of relationships containing TSE-VOLs, and at least one is in Failed State.
		I	The volumes specified by DEVN are source volumes of relationships containing TSE-VOLs, and at least one is in write inhibit.
		B	The volumes specified by DEVN are source volumes of relationships containing TSE-VOLs, and relationships in failed state and write inhibit are mixed.
SEQNUM	00000000	Displays the Sequence Number. However, since Compatible FlashCopy® V2 does not support this function, "00000000" will always be displayed for this item. For details about Sequence Number, see the <i>IBM® PPRC</i> manual.	
<p><b>Notes:</b></p> <ol style="list-style-type: none"> <li>In case the volume is set online in more than one LPAR defined by the mainframe system host.</li> <li>The SE item might not display correctly when the following conditions occur at the same time: <ul style="list-style-type: none"> <li><b>FCQUERY</b> is executed with the SHOWRELS parameter omitted.</li> <li>The specified volume is the source volume of a volume relationship having 13 or more target volumes.</li> </ul> </li> </ol> <p>You can avoid this situation by specifying the SHOWRELS parameter when running <b>FCQUERY</b>. To omit detailed information about the relationships, specify SHOWRELS(NO), which is equivalent to the omission of the SHOWRELS parameter.</p>			

ACT shows the total number of the active Compatible FlashCopy® V2 relationships in each data set. In the first case of the following figure, VOL#0 has one active relationship within. Since the number of relationships is counted for each data set, "2" displays as the value of ACT for the volume even though there is only one relationship. In the second case, VOL#0 and the VOL#1 have two active relationships. Each volume has two data sets for the relationships, and thus "2" displays as the value of ACT for each volume.

· Relationship within a volume



· Relationships between two volumes

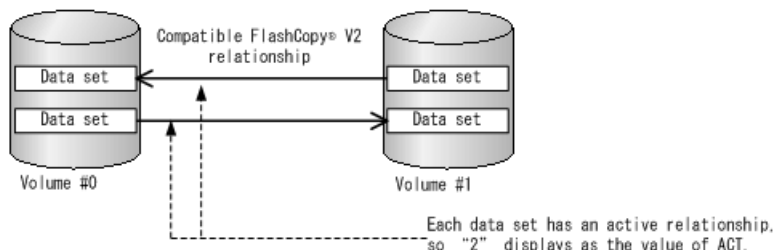

**Figure 26 The number of relationships displayed in ACT**

See [Table 32 FCQUERY command output on page 104](#) for descriptions of the **FCQUERY** output values.

The following is an example of the **FCQUERY** command using the **SHOWRELS** parameter.

```
FCQUERY DEVN(1900) SHOWRELS(ALL)
ANTF0421I FCQUERY Relationship 1
DEVN SSID LSS CCA CU SERIAL ACT MAX XC PC CC RV SE
SEQNUM
1900 12C0 00 00 2107 000000064552 2 1000 N N N N NN
00000000
RELATIONSHIP DETAIL STARTING TRACK: 00000000
DEVICE LONG BUSY FOR CG: NO WRITE INHIBITED: NO
-----
PARTNER SOURCE TARGET S F C C P C T S F P
LSS CCA SSID START START O V O A R R W E S M
-----
00 01 12C0 00010000 00120000 Y N N N N N Y N N N
NO. OF TRACKS: 000000FF TRACKS TO COPY: 000000FF
ESTABL: 2011/09/15 09:31:50 LAST INCR: 2011/09/15
09:31:50
00 01 12C0 00230000 00340000 Y N N N N N Y N N N
NO. OF TRACKS: 000000FF TRACKS TO COPY: 000000FF
ESTABL: 2011/09/15 09:31:50 LAST INCR: 2011/09/15
09:31:50
```

**Table 32 FCQUERY command output**

Item	Value	Description
RELATIONSHIP DETAIL STARTING TRACK	Starting address	CCHH number of the starting address. The CCHH number specified here is displayed if the STARTADDR parameter is specified. "00000000" is displayed if the STARTADDR parameter is not specified.
DEVICE LONG BUSY FOR CG	Y	The consistency of the extent is maintained.
	N	The consistency of the extent is not maintained.
WRITE INHIBITED	Y	Writing is not allowed.
	N	Writing is allowed.
LSS	CU number	CU number
CCA	LDEV number	LDEV number in the CU
SSID	Storage subsystem ID	Storage subsystem ID
SOURCE START	Starting source extent CCHH number	The starting CCHH number of the copy source extent
TARGET START	Starting target extent CCHH number	The starting CCHH number of the copy target extent
SO	Y	This is a source volume of a relationship.
	N	This is a target volume of a relationship.
FV	Y	The relationship is established for the full volume.
	N	The relationship is not established for the full volume.
CO	Y	The relationship is created with COPY mode.
	N	The relationship is created with NOCOPY mode.
CA	Y	Background copy is active.
	N	Background copy is not active.
PR	Y	It is a persistent relationship.
	N	It is not a persistent relationship.
CR	Y	Changes are recorded as differential data if the S-VOL and T-VOL are updated. This is an incremental relationship.
	N	Changes are not recorded as differential data, even if the S-VOL and T-VOL are updated. This is not an incremental relationship.
TW	Y	Writing to the T-VOL is allowed.
	N	Writing to the T-VOL is not allowed.
SE	N	The T-VOL is not a TSE-VOL.

Item	Value	Description
	F	The T-VOL is a TSE-VOL. (When the pool is full, the relationship is in failed state.)
	I	The T-VOL is a TSE-VOL. (When the pool is full, writing to the S-VOL is not allowed.)
FS	Y	The relationship is in failed state.
	N	The relationship is not in failed state.
PM	N	The relationship is established without using the Preserve Mirror FlashCopy® function.
	P	The relationship is established by specifying PREFERRED in the Preserve Mirror FlashCopy® function.
	R	The relationship is established by specifying REQUIRED in the Preserve Mirror FlashCopy® function.
	S	The relationship is established between the two TCz S-VOLs with the Preserve Mirror FlashCopy® function.
	U	The relationship is in the status where the type of the Preserve Mirror FlashCopy® function (PREFERRED or REQUIRED) cannot be identified because the P-VOL and S-VOL of TCz are mixed.
NO. OF TRACKS	Number of tracks	The number of tracks in the relationship.
TRACKS TO COPY	Number of tracks	Displays the number of tracks that have not been copied.

## Using ICKDSF to view details of Compatible FlashCopy® V2 relationships

The following tables show the parameters for the ICKDSF **FLASHCPY QUERY** and **FLASHCPY QUERY RELATIONS** commands.

**Table 33 ICKDSF FLASHCPY QUERY command parameters**

Command	Parameter	Value	Description
FLASHCPY QUERY	DDNAME or DNAME	JCL statement	Sets the JCL statement identifying the volume. If the host server OS is z/OS®, this parameter or the UNITADDRESS parameter is required.
	SYSNAME	SYSNAME	Sets the SYSNAME in the ASSGN system control statement. If the host server OS is VSE, this parameter is required.
	UNITADDRESS, UNITADDR, or UNIT	Source device number	Specifies the device number (device address) of the S-VOL on which you want to perform the <b>FLASHCPY QUERY</b> command. If the host server OS is z/OS®, this parameter or the DDNAME parameter is required.
	SOURCEVOL or SRCVOL	CU number LDEV number Source device number	Specifies the CU number, the LDEV number, or the device number of the S-VOL when you use the Remote FlashCopy® function.

**Table 34 ICKDSF FLASHCPY QUERY RELATIONS command parameters**

Command	Parameter	Value	Description
FLASHCPY QUERY RELATIONS	DDNAME or DNAME	JCL statement	Sets the JCL statement identifying the volume. If the host server OS is z/OS®, this parameter or the UNITADDRESS parameter is required.
	SYSNAME	SYSNAME	Sets the SYSNAME in the ASSGN system control statement. If the host server OS is VSE, this parameter is required.
	UNITADDRESS, UNITADDR, or UNIT	Source device number	Specifies the device number (device address) of the S-VOL on which you want to perform the FLASHCPY QUERY command. If the host server OS is z/OS®, this parameter or the DDNAME parameter is required.

### Displaying information about relationships: FLASHCPY QUERY

To display information about a Compatible FlashCopy® V2 relationship, execute the **ICKDSF FLASHCPY QUERY** command. For example:

```
FLASHCPY QUERY UNIT(X'7000')
```

An example of the **FLASHCPY QUERY** command follows:

```
FLASHCOPY VOLUME CAPABILITY INFORMATION TABLE
          MAXIMUM          MAXIMUM
EXISTING  ALLOWED          RELATIONS
RELATIONS RELATIONS      EXCEEDED   CAPABILITY
-----  -
          1             1000          NO          SRC CAP
                                          TGT CAP

CAPABILITY LEGEND
ASY PVOL = ASYNCHRONOUS PPRC REMOTE COPY PRIMARY
CC SRC   = CONCURENT COPY SOURCE
INACCESS = VOLUME INACCESSIBLE, DATA NOT OBTAINABLE
INHIBIT  = FLASHCOPY INHIBITED ON THIS-VOLUME
MAX EXCD = MAXIMUM RELATIONS EXCEEDED AT-VOLUME OR ESS LEVEL
NEITHER  = VOLUME NEITHER FC SOURCE NOR FC TARGET CAPABLE
PPRC PRI = PPRC PRIMARY
PPRC SEC = PPRC SECONDARY
PHASE 1  = PHASE 1 (VERSION 1) RELATIONSHIP EXISTS ON VOLUME
SRC CAP  = FLASHCOPY SOURCE CAPABLE
TGT CAP  = FLASHCOPY TARGET CAPABLE
XRC SRC  = XRC SOURCE
```

The following table shows the information displayed after executing the **FLASHCPY QUERY** command.

**Table 35 FLASHCPY QUERY command output**

Item	Value	Description
EXISTING RELATIONS	Number of relationships	Displays the number of relationships in the specified volumes.

Item	Value	Description
MAXIMUM ALLOWED RELATIONS	Number of relationships	Displays the maximum number of relationships that can be created in the specified volumes.
MAXIMUM RELATIONS EXCEEDED	NO	Specifies that the number of relationships in the specified volume does not reach the maximum number of relationships that can be created in the specified volume.
	YES(VOL)	Specifies that the maximum number of relationships that can be created in the specified volume has already been created.
	YES(ESS)	Specifies that the maximum number of the relationships that can be created in the storage system has already been created.
CAPABILITY	SRC CAP	The specified volume can be used as an S-VOL for Compatible FlashCopy® V2.
	TGT CAP	The specified volume can be used as a T-VOL for Compatible FlashCopy® V2.
	NEITHER	The specified volume cannot be used as an S-VOL or T-VOL for Compatible FlashCopy® V2.
	PPRCOPY PRI	The specified volume is a copy source volume used by TrueCopy for Mainframe.
	PPRCOPY SEC	The specified volume is a copy target volume used by TrueCopy for Mainframe.
	CC SRC	The specified volume is a copy source volume used by Concurrent Copy.
	INHIBIT	The specified volume cannot be used by Compatible FlashCopy® V2.
	MAX EXCD	Specifies that the maximum number of relationships that can be created in the specified volume has already been created.
	PHASE 1	Specifies that a Version 1 relationship exists in the specified volume.
	INACCESS	Specifies that you cannot access the specified volume.



**Note:** The previous example displays the description of ASY PVOL in the CAPABILITY LEGEND, but VSP G1000 and G1500, and VSP F1500 does not support this item. If the **FLASHCPY QUERY** command is executed on a Compatible FlashCopy® V2 relationship, the ASY PVOL will not be displayed in the CAPABILITY output.

## Displaying information about Compatible FlashCopy® V2 relationships: FLASHCPY QUERY RELATIONS

To view information about all relationships in a specified volume, execute the ICKDSF **FLASHCPY QUERY RELATIONS** command. For example:

```
FLASHCPY QUERY RELATIONS UNIT(X'7001')
```

An example of the **FLASHCPY QUERY RELATIONS** command output follows.

FLASHCOPY RELATIONS INFORMATION TABLE  
 ADDRESSED VOLUME CU SERIAL NUMBER: 0000064552

ADDRESSED VOLUME INFORMATION															PARTNER VOLUME INFO							
FLASHCPY SEQUENCE NUMBER	R/T	FV	BCE	BCP	CRA	VR	SWI	TWP	P	SEVI	PM	SOURCE	TARGET	TRKS IN EXTENT	# CONTIG	# TRACKS YET TO BE COPIED	SSID	LSS	CCA	SSID	LSS	CCA
00000000	SRC	F	F	F	F	F	F	F	F	F	F	N 00010000	00120000	255		255	12C0	00	00	12C0	00	01
00000000	SRC	F	F	F	F	F	F	F	F	F	F	N 00230000	00340000	255		255	12C0	00	00	12C0	00	01

LEGEND  
 R/T = FLASHCOPY RELATIONSHIP TYPE OF ADDRESSED VOLUME (SRC = SOURCE, TGT = TARGET)  
 R = REVERTIBLE (TRUE | FALSE)  
 FV = FULL VOLUME RELATION (TRUE | FALSE)  
 BCE = BACKGROUND COPY ENABLED (TRUE | FALSE)  
 BCP = BACKGROUND COPY IN PROGRESS (TRUE | FALSE)  
 CRA = CHANGE RECORDING ACTIVE (TRUE | FALSE)  
 VR = VALIDATION REQUIRED (T|F), REPORTED INFORMATION NOT CURRENT AND MAY NOT BE ACCURATE  
 SWI = SOURCE EXTENT WRITE INHIBITED (TRUE | FALSE | TFR = WRITE INHIBITED DUE TO FULL REPOSITORY)  
 TWP = TARGET EXTENT WRITE PROTECTED (TRUE | FALSE)  
 P = EXTENTS IN PERSISTENT RELATION (TRUE | FALSE)  
 SEVI = SPACE EFFICIENT VOLUME INFORMATION LEGEND:  
 S = VOLUME QUERIED IS SPACE EFFICIENT (TRUE | FALSE)  
 E = TARGET VOLUME IS SPACE EFFICIENT (TRUE | FALSE) WILL BE FALSE IF VOLUME QUERIED IS A TARGET  
 V = FLASHCOPY RELATION WILL BE FAILED IF TARGET IS OUT OF SPACE (TRUE | FALSE)  
 I = FLASHCOPY RELATION IS IN A FAILED STATE (TRUE | FALSE)  
 PM = PRESERVE MIRROR RELATIONSHIP INFORMATION LEGEND:  
 N = NOT A MIRRORING RELATIONSHIP  
 P = MIRRORING RELATIONSHIP, PREFERRED SPECIFIED  
 R = MIRRORING RELATIONSHIP, REQUIRED SPECIFIED  
 S = REMOTE MIRRORING RELATIONSHIP AT PPRC SECONDARY  
 U = MIRRORING RELATIONSHIP UNDETERMINED  
 N/A = NOT AVAILABLE

**Figure 27 FLASHCPY QUERY RELATIONS command output**



**Note:** The contents displayed in the ADDRESSED VOLUME INFORMATION is the information about the relationships in the volume specified by the **FLASHCPY QUERY RELATIONS** command. The contents displayed in the PARTNER VOLUME INFO is the information about the volume that has the paired relationships for the volume specified by the **FLASHCPY QUERY RELATIONS** command.

The following table describes the **FLASHCPY QUERY RELATIONS** command output.

**Table 36 FLASHCPY QUERY RELATIONS command output**

Item	Value	Description
FLASHCPY SEQUENCE NUMBER	00000000	Displays the sequence number. However, since Compatible FlashCopy® V2 does not support sequence numbers, "00000000" is always displayed for this item.
R/T	SRC	Specifies that this is a Compatible FlashCopy® V2 source volume.
	TGT	Specifies that this is a Compatible FlashCopy® V2 target volume.

Item	Value	Description
R	F	Displays whether the device (volume) specified by DEVN is revertible or not. Since Compatible FlashCopy® V2 does not support this function, F will always be displayed.
FV	T	Specifies that the relationship is established at the volume level.
	F	Specifies that the relationship is established at the extent level.
BCE	T	Specifies that the background copy operation is set to execute.
	F	Specifies that the background copy operation is set not to execute.
BCP	T	Specifies that the background copy operation is running.
	F	Specifies that the background copy operation is not running.
CRA	T	Specifies that changes are recorded as differential data. This is an incremental relationship.
	F	Specifies that this is not an incremental relationship.
VR	T	Specifies that the displayed information is the latest, and that it is accurate.
	F	Specifies that the displayed information is not the latest and might not accurately represent the current state.
SWI	T	Specifies that writing to the S-VOL is not allowed.
	F	Specifies that writing to the S-VOL is allowed.
TWP	T	Specifies that writing to the T-VOL is not allowed.
	F	Specifies that writing to the T-VOL is allowed.
P	T	Specifies that extent consistency is maintained.
	F	Specifies that extent consistency is not maintained.
START OF EXTENT(SOURCE)	CCHH number	Displays the starting CCHH of the source extent.
START OF EXTENT(TARGET)	CCHH number	Displays the starting CCHH of the target extent.
# CONTIG TRKS IN EXTENT	Number of tracks	Displays the number of tracks in the relationship.
# TRACKS YET TO BE COPIED	Number of tracks	Displays the number of tracks that have not finished copying in the relationship.
SSID	Storage subsystem ID	Displays the SSID (storage subsystem ID) of the storage system where the relationship belongs.
LSS	CU number	Displays the CU number of the volume where the relationship exists.
CCA	LDEV number	Displays the logical device number in the control unit of the storage system in which the relationship exists.
S	T	Specifies that this volume is a TSE-VOL.
	F	Specifies that this volume is a normal volume.
E	T	Specifies when the command is issued to the S-VOL, the T-VOL is a TSE-VOL.

Item	Value	Description
	F	Specifies when the command is issued to the S-VOL, the T-VOL is a normal volume. If the command is issued to the T-VOL, the T-VOL is a normal volume or a TSE-VOL.
V	T	Specifies when the pool provisioning the T-VOL becomes full, the relationship will be in failed state.
	F	Specifies when the pool provisioning the T-VOL becomes full, the relationship will not be in failed state.
I	T	Specifies that the relationship is in failed state.
	F	Specifies that the relationship is in normal state.
PM	N	Specifies that the relationship has been established without using the Preserve Mirror FlashCopy® function.
	P	Specifies that the relationship has been established by specifying PREFERRED in the Preserve Mirror FlashCopy® function.
	R	Specifies that the relationship has been established by specifying REQUIRED in the Preserve Mirror FlashCopy® function.
	S	Specifies that the relationship has been established between two TCz S-VOLs with the Preserve Mirror FlashCopy® function.
	U	Specifies that the relationship is in the status where the type of the Preserve Mirror FlashCopy® function (PREFERRED or REQUIRED) cannot be identified, because the P-VOL and S-VOL of TCz are mixed.

The output of the **FLASHCPY QUERY RELATIONS** command determines if you can execute the Restore or Reverse Restore functions.

If the following condition is met, you can execute the Restore function.

- CRA = T

If all of the following conditions are met, you can execute the Reverse Restore function.

- BCE = T
- BCP = F
- CRA = T
- #TRACKS YET TO BE COPIED = 0

## Using ANTRQST macro to view the state of Compatible FlashCopy® V2 relationships

The following table describes the parameters you can use with the **ANTRQST** macro **REQUEST = FCQUERY**.

**Table 37 ANTQRST macro REQUEST = FCQUERY parameters**

Parameter	Value	Description
DEVN	Device number	Specifies the number (device address) of the device on which you want to execute the <b>FCQUERY</b> command.
QRYSIZE	Data length	Specifies the length of data obtained with <b>QRYINFO</b> .
FORMAT	FQMAP	Obtains QUERY information using the ANTFQMAP macro format. For details about the format, see the IBM® manual or the macro source.
	NO	Obtains QUERY information with the format not using the <b>ANTFQMAP</b> macro command.  NO is the default setting.
QRYINFO	QUERY Information (Return Value)	Obtains information such as pair volume attributes of Compatible FlashCopy® V2 relationships and the number of relationships. For details about the information, see the IBM® DFSMS Advanced Copy Services manual.
RETINFO	Return value	Obtains the return code and the reason code of the execution results. For details about the codes, see the IBM® DFSMS Advanced Copy Services manual.
REMOTE	YES	The request is to a device that not directly connected to the host on which the macro is performed.
	NO	The request is to a device that is connected to the local host.  NO is the default setting.
QRYSERIAL	Device number	Specifies the device number of the S-VOL which you want to perform the <b>FCQUERY</b> command.  Use this parameter when REMOTE is YES.
QRYLSS	CU number	Specifies the CU number of the S-VOL which you want to perform the <b>FCQUERY</b> command.  Use this parameter when REMOTE is YES.
QRYSSID	SSID	Specifies the SSID of the CU on which you establish the FlashCopy® relationship.  Use this parameter when REMOTE is YES.

## Using z/VM CP to view the state of Compatible FlashCopy® V2 relationships

Use the z/VM CP **QUERY VIRTUAL FLASHCOPY** command to view information about a Compatible FlashCopy® V2 relationship.

The z/VM CP **QUERY VIRTUAL FLASHCOPY** parameters are shown in the following table.

**Table 38 QUERY VIRTUAL FLASHCOPY command parameters**

Parameter	Description
ALL	Displays information about all of the virtual devices.

Parameter	Description
	ALL is the default setting.
vdev	Only displays information about the specified virtual device.
vdev1-vdev2	Displays information about the virtual devices in the specified range.

An example of the **QUERY VIRTUAL FLASHCOPY** command follows.

```

QUERY VIRTUAL FLASHCOPY
VDEVN  SSID  LSS  UA  CU   SERIAL          ACTIVE    MAX  PPRC
0010   0132  02  00  2107  0000000048151    1    50099
0020   0132  02  01  2107  0000000048151    1    50099

```

## Viewing resource information from Device Manager - Storage Navigator

You can use Device Manager - Storage Navigator (HDvM - SN) to view resource information:

- License information is displayed in the Replication window.
- Consistency group information is displayed in the Local Replication window (see [Viewing consistency group information on page 112](#)).
- Relationship operation history is displayed in the Replication window (see [Viewing relationship operations history on page 112](#)).

### Viewing consistency group information

You can view the following information for consistency groups:

- The number of consistency groups. Use the Summary section of the Local Replication window.
- A list of consistency groups including their status and the number of pairs. Use the Consistency Groups tab in the Local Replication window.
- A consistency group's properties. Use the CTG ID link on the Consistency Groups tab in the Local Replication window.

### Viewing relationship operations history

You can review the operations that have been performed on a relationship in the History window. A maximum of 1,024,000 latest operations are stored in the storage system.

#### Procedure

1. Open the **History** window.
  - a. In the Storage Systems tree, select **Replication**.
  - b. In the **Replication** window, click **View History > Local Replication**.

2. In the Copy Type list, select the type of relationship you want to view. For Compatible FlashCopy® V2 history, select **FCv2/FCSE**. The **Description** column explains what operations that have been performed.

## History window messages for Compatible FlashCopy® V2

Code	Message	Description
0010 <sup>1</sup>	COPY STARTED (FC)	The background copy operation has started.  This message displays: <ul style="list-style-type: none"> <li>• When the relationship is established, not when the copy operation starts.</li> <li>• When the relationship is established without specifying the CHGRECORD option of the <b>FLASHCOPY ESTABLISH</b> command of z/VM.</li> </ul>
0011	1st INCREMENTAL COPY STARTED	The initial copy operation has started. This message displays when the relationship is established and not when the copy operation starts.
0012	2nd or LATER INCREMENTAL COPY STARTED	The second or later incremental copy operation has started. This message is displayed when the relationship is established and not when the copy operation starts.
0013	1st NOCOPY RELATIONSHIP ESTABLISHED (INCREMENTAL)	The relationship was established by the Incremental FlashCopy® function in NOCOPY mode.
0014	2nd or LATER NOCOPY RELATIONSHIP ESTABLISHED (INCREMENTAL)	The relationship initially established by the Incremental FlashCopy® function was re-established in NOCOPY mode.
0015	2nd or LATER INCREMENTAL COPY STARTED (REVERSE RESTORE)	The Reverse Restore function started a second or later incremental copy with a relationship that was initially established by the Incremental FlashCopy® function.  This message is displayed when the relationship is re-established and not when the copy operation starts.
0016	2nd or LATER NOCOPY RELATIONSHIP ESTABLISHED (REVERSE RESTORE)	The relationship initially established by the Incremental FlashCopy® function was re-established by Reverse Restore in NOCOPY mode.
0019	INITIALIZE STARTED (FC)	The initialization processing started.
0020 <sup>1</sup>	COPY ENDED (FC)	The background copy operation ended.
0022	RELATIONSHIP DELETED (FC)	The relationship was deleted.
0023 <sup>1</sup>	NOCOPY RELATIONSHIP ESTABLISHED (FC)	The relationship was created in NOCOPY mode.  This message displays when you establish the relationship for NOCOPY mode without specifying the CHGRECORD option of the z/VM <b>FLASHCOPY ESTABLISH</b> command.
0024	COPY ENDED (Relationship maintained)	The copy operation ended and the relationship is still maintained. This message displays after the copy operation is completed when the relationship is established without specifying the CHGRECORD option of the z/VM <b>FLASHCOPY ESTABLISH</b> command.
0029	INITIALIZE ENDED NORMAL (FC)	The initialization processing terminated normally.
002A	COPY ENDED ABNORMAL (FC)	The copy operation ended abnormally.

Code	Message	Description
002F	INITIALIZE ENDED ABNORMAL (FC)	The initialization processing terminated abnormally.
0030	COPY STARTED AFTER MODE CHANGED (FC)	The background copy operation started after the relationship changed to COPY mode.
003A	DELETED BY SM VOLATILIZING (FC)	The relationship was deleted due to volatilization of the shared memory.
003B	SUSPEND (FC)	The relationship was suspended due to an error or failure.
	HIERARCHICAL MEMORY ACCESS ERROR SUSPENDED (FC)	The relationship was suspended due to a failure when accessing the tier memory. When this message displays, information for the failed volume displays in the LDEV ID and Provisioning Type column under the Source Volume of the History window. A hyphen displays for LDEV ID, Provisioning Type and Relationship ID of the Target Volume.
0040	2nd or LATER INCREMENTAL COPY STARTED (FAST REVERSE RESTORE)	The Fast Reverse Restore function started a second or later incremental copy with a relationship initially established by the Incremental FlashCopy® function. This message is displayed when the relationship is re-established, not when the copy operation starts.
0041	COPY STARTED (FAST REVERSE RESTORE)	The Fast Reverse Restore function started a second or later incremental copy. This message is displayed when the relationship is re-established, not when the copy operation starts.
0042	2nd or LATER INCREMENTAL NOCOPY RELATIONSHIP ESTABLISHED (FAST REVERSE RESTORE)	The relationship initially established by the Incremental FlashCopy® function was re-established by the Fast Reverse Restore in NOCOPY mode.
0043	NOCOPY RELATIONSHIP ESTABLISHED (FAST REVERSE RESTORE)	The relationship established by the Fast Reverse Restore function was re-established in NOCOPY mode.
0060	INHIBITING OUTPUT TO EXCEED 1000 RELATIONSHIPS IN THIS VOL	The output of operation histories stopped because the number of the Compatible FlashCopy® V2 relationships processed exceeded 1000.
0061 <sup>2</sup>	ALL RELATIONSHIPS IN THIS VOL COMPLETED	Processing for the Compatible FlashCopy® V2 relationships completed.
<p><b>Notes:</b></p> <ol style="list-style-type: none"> <li>1. All operation histories are displayed up to the first 1000 operation histories per volume. If the number of operation histories exceeds 1000, the display is updated in increments of 10 histories (999 histories, 1000 histories, no display updates for 1001-1009 histories, then 1010 histories are displayed, then 1020 histories, and so on).</li> <li>2. When this code is output, a hyphen (-) is displayed as the LDEV ID, Provisioning Type, and Relationship ID of the target volume.</li> </ol>		

## History window messages for HCFCSE

Code	Message	Description
0050	NOCOPY RELATIONSHIP ESTABLISHED (HCFCSE)	The creation of the HCFCSE relationship in NOCOPY mode completed.
0051	RELATIONSHIP DELETED (HCFCSE)	The relationship was deleted.

Code	Message	Description
0052	RELATIONSHIP DELETED with RELEASING ALLOCATED SPACE (HCFCE)	The relationship was deleted by the <b>FCWITHDR</b> command and the allocated space was released.
0053	NOCOPY RELATIONSHIP ESTABLISHED (FAST REVERSE RESTORE)	The relationship was re-established with the S-VOL and the T-VOL reversed by the Fast Reverse Restore function in NOCOPY mode.
0054	FAILED STATE (HCFCE)	Failed states occurred.
0055	SUSPENDED (HCFCE)	The copy operation was suspended due to a failure.
	HIERARCHICAL MEMORY ACCESS ERROR SUSPENDED (FCSE)	The relationship was suspended due to a failure when accessing the tier memory. When this message displays, information for the failed volume displays in the LDEV ID and Provisioning Type column under the Source Volume of the History window. A hyphen displays for LDEV ID, Provisioning Type and Relationship ID of the Target Volume.
0056*	TSEVOL INITIALIZATION WASPROCESSED	The allocated spaces of TSE-VOL have been released.
0057	COPY STARTED (HCFCE FAST REVERSE RESTORE)	The relationship was re-established with the S-VOL and the T-VOL reserved by the Fast Reverse Restore function in COPY mode.
0058	COPY ENDED (HCFCE)	The background copy operation ended.
0059	COPY ENDED ABNORMAL (HCFCE)	The copy operation ended abnormally.
005A	COPY STARTED AFTER MODE CHANGED (HCFCE)	The operation mode is changed from NOCOPY to COPY. The background copy operation started.
*When this code is output, a hyphen (-) is displayed as the LDEV ID, Provisioning Type, and Relationship ID of the target volume.		

## Releasing Compatible FlashCopy® V2 relationships

To release Compatible FlashCopy® V2 relationships, use any of the following types of commands:

- PPRC TSO
- DFSMSdss
- ANTRQST macro
- z/VM CP

### Avoiding timeouts when releasing relationships

- If you release more than 100 FlashCopy® relationships at the same time, a timeout might occur. To avoid these timeouts, divide the tasks into small groups and release relationships at intervals of about five seconds per 100 relationships.

A withdraw command deletes relationships in the volume all at once, so a timeout might occur if you execute a withdraw command when the number of relationships per volume is large and the MP operating rate of the MP blade is high. To avoid these timeouts, ensure the maximum number of relationships per volume does not exceed 4000.

- If an MIH occurs and cancellation of a relationship ends abnormally, the relationship remains in effect. If this occurs, re-execute the withdraw command.
- When you cancel a large number of relationships, the cancel relationships process might cause an MIH to occur. To prevent this, complete background copy operations before you cancel relationships.
- To prevent an MIH from occurring, reduce the number of relationships to be canceled with one command to 4000 or less. This also applies when you execute the **INIT**, **SCRATCH**, or **DELETE** commands, which cause the withdraw command to be issued during processing.

## Using PPRC TSO to release Compatible FlashCopy® V2 relationships

Use the **FCWITHDR** command to release relationships established using COPY or NOCOPY mode.

The following table shows the **FCWITHDR** command parameters used to release Compatible FlashCopy® V2 relationships.

**Table 39 FCWITHDR command parameters (Compatible FlashCopy V2)**

Parameter	Value	Description
SDEVN	Source device number.	Specifies the number (device address) of the S-VOL on which to perform the <b>FCWITHDR</b> command.
TDEVN	Target device number.	Specifies the number (device address) of the T-VOL on which to perform the <b>FCWITHDR</b> command.
DEVN	Device number.	Specifies the number (device address) of the device on which to perform the <b>FCWITHDR</b> command with ACTION parameter.
	TCz source device number	Specifies a TCz P-VOL (device address). Use this parameter when REMOTE is YES.
DDSW	YES	Specifies that all relationships involving the device specified by SDEVN are withdrawn. Any NOCOPY relationships are converted to COPY and the copy operations for all relationships are completed before the relationship is withdrawn. The DDSW parameter cannot be used with HCFDSE.
	NO	Specifies that the relationships specified by the SDEVN parameter are withdrawn without data space withdraw considerations. See the <i>IBM® z/OS DFSMS Advanced Copy Services</i> manual for more information. NO is the default setting.
XTNTLST	Extent (range to withdraw the relationship)	Specifies the extent range to withdraw by setting the starting and ending addresses of the source extent and the starting and ending addresses of the target extent with CCHH. Up to 32 extents can be specified.  When XTNTLST is not specified, the relationships on all of the tracks are withdrawn. XTNTLST can only be used when the number of cylinders for the source is 65,520 or less. XTNTLST cannot be used for Extended Addressable Volumes (EAV).

Parameter	Value	Description
XXTNTLST	Extent (range to withdraw the relationship)	Specifies the extent range to withdraw by setting the starting and ending addresses of the source extent and the starting and ending addresses of the target extent with cccccch (cylinder and head numbers) when either or both the source and target exceeds 65,520 cylinders. Up to 32 extents can be specified. When using EAVs, use XXTHLST to specify extents.
ACTION	THAW	Resume write operations from the host for volumes that belong to the same CU as the device specified by the DEVN parameter.
TGTUCB	YES	Specifies that the z/OS® device number specified in the SDEVN and TDEVN parameters is to be used.  YES is the default setting.
	NO	Specifies that the serial number, the CU number, and the LDEV number of the T-VOL are specified to perform the <b>FCWITHDR</b> command. To specify this number, use the TARGET parameter instead of TDEVN.
TARGET	Serial number, CU number, LDEV number of the T-VOL	Specifies the serial number, the CU number, and the LDEV number of the T-VOL for which you want to perform the <b>FCWITHDR</b> command. Use this parameter when TGTUCB is NO.
REMOTE	YES	Use the Remote FlashCopy® function to withdraw the relationship.
	NO	Do not use the Remote FlashCopy® function.  NO is the default setting.
SOURCE	Serial number, the CU number and the LDEV number of the S-VOL	Specifies the serial number, the CU number and the LDEV number of the S-VOL on which you want to perform the <b>FCWITHDR</b> command.  Use this parameter when REMOTE is YES.
SSID	SSID	Specifies the SSID of the CU on which you withdraw the FlashCopy® relationship.  Use this parameter when REMOTE is YES.

To use the XTNTLST or XXTNTLST parameter, the size of the copy source extent and the copy target extent must be the same.

When you execute the **FCWITHDR** command, the combination of parameters that you specify will determine the command output. The following table shows the results of these combinations.

**Table 40 Output results from FCWITHDR command parameter combinations**

Relationship activity	Parameter combinaton or relationship status	Results
Unspecified	<ul style="list-style-type: none"> <li>DDSW parameter set to NO</li> <li>DDSW parameter is not specified</li> </ul>	The relationships specified in the command are withdrawn when the command is executed.
	When the specified device has no relationships to withdraw	The command will do nothing and end normally.

Relationship activity	Parameter combinaton or relationship status	Results
	When the specified device has no relationships that fall within the range specified by the XTNTLST or XXTNTLST parameter	The <b>FCWITHDR</b> command will do nothing and end normally.
	DDSW parameter set to YES	The relationships for the volume specified by the SDEVN parameter are withdrawn based on the MODE (COPY mode or NOCOPY mode) with which each relationship was established. The individual relationships are released as indicated in this table based on the mode of each relationship. All relationships are withdrawn as the appropriate conditions are met.
FCWITHDR is issued for a relationship in COPY mode and the copy has not completed.	The ongoing background copy operation is stopped and cancelled.	The relationships specified in the command are withdrawn.
	DDSW parameter set to YES	The relationships established with the specified copy source extents on the volume specified by SDEVN are withdrawn after the background copy is completed.
FCWITHDR is issued for a relationship in NOCOPY mode.	DDSW parameter set to YES	The relationships established with the device specified in the SDEVN parameter are changed to COPY mode, and each relationship is withdrawn after the background copy for that relationship completes.

The following table lists the **FCWITHDR** parameter combinations that will result in successful execution.

**Table 41 Valid parameter combinations with the FCWITHDR command (Compatible FlashCopy V2)**

Case number	Parameter values						ACTION
	SDEVN	TDEVN	DEVN	DDSW setting	XTNTLST or XXTNTLST		
					Source	Target	
1	Not specified	Specified	Not specified	No	Not specified	Not specified	Not specified
2	Not specified	Specified	Not specified	No	Specified	Specified	Not specified
3	Specified	Specified	Not specified	No	Not specified	Not specified	Not specified
4	Specified	Specified	Not specified	No	Specified	Specified	Not specified
5	Specified	Specified or not specified	Not specified	Yes	Not specified	Not specified	Not specified
6	Specified	Specified or not specified	Not specified	Yes	Specified	Specified	Not specified

Case number	Parameter values						ACTION
	SDEVN	TDEVN	DEVN	DDS W setting	XTNTLST or XXTNTLST		
					Source	Target	
7	Not specified	Not specified	Specified	No	Not specified	Not specified	THAW

The extents information specified by the XTNTLST or XXTNTLST parameter is valid only when the following conditions are met:

- The value used for the XTNTLST or XXTNTLST parameter is for both the source and target. If the value is only set for one of the two, the copy operation will fail.
- The size of the specified copy source and copy target extents is same.
- The relationship is established with INCREMENTAL = NO or is established without INCREMENTAL.



**Caution:** Data on the T-VOL might be inconsistent if the relationships are withdrawn by FCWITHDR and the DDSW parameter is either set to NO or it is not set.

### Case 1: TDEVN specified, DDSW = NO

All relationships established with the target extents in the device specified by TDEVN are withdrawn.

An example of the **FCWITHDR** command for Case 1 follows. This command requests the withdrawal of all relationships established with target extents in device 4203.

```
FCWITHDR TDEVN(X'4203')
```

When this **FCWITHDR** command is executed, the relationship established with the specified target, Dataset 3 in device 4203, is withdrawn, but the relationship established with Dataset 4 is not withdrawn because it is specified as the source. There are two relationships before this **FCWITHDR** command is executed, and there is only one relationship after this **FCWITHDR** command is executed.

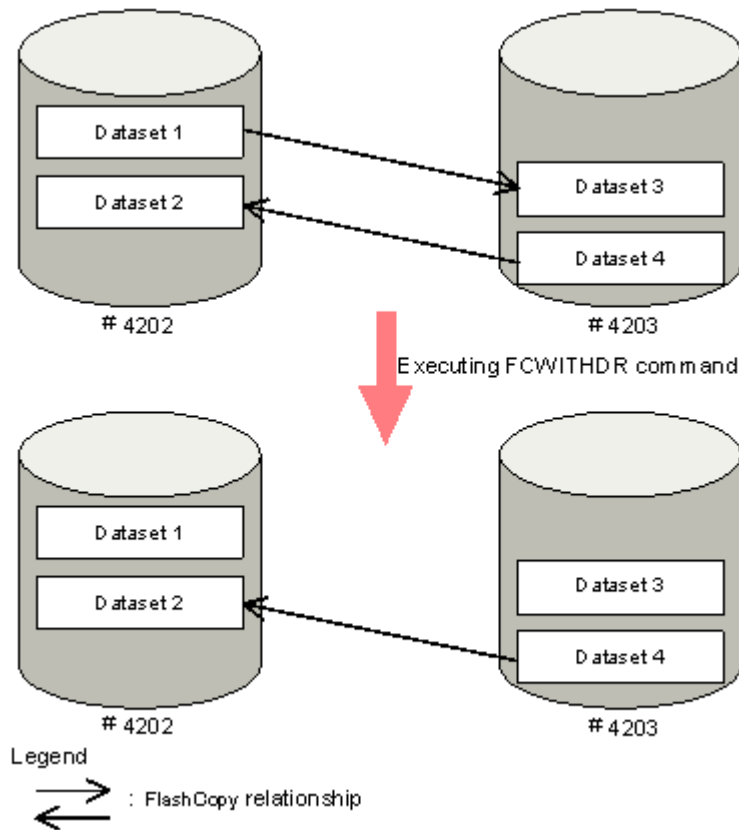

**Figure 28 Case 1: FCWITHDR command (TDEVN: specified, DDSW = NO)**

**Case 2: TDEVN specified, DDSW = NO, XTNTLST or XXTNTLST parameter specified**

In this example, relationships in TDEVN that are specified by XTNTLST or XXTNTLST are withdrawn. If only part of an extent is specified in XTNTLST or XXTNTLST, the relationship that includes that extent is not withdrawn.

This example requests the withdrawal of all of the relationships established with the target extents included in the specified extents for device 4203.

```
FCWITHDR TDEVN(X'4203') XTNTLST(X'00000000' X'
03000000E' X'20000000' X' 23000000E')
```

The specified extents in device 4203 are contained in Dataset 3. When the **FCWITHDR** command is executed, the relationship established with Dataset 3 is withdrawn. There are two relationships before the **FCWITHDR** command above is executed, and there is only one relationship after the **FCWITHDR** command above is executed.

Dataset 1: CCHH=(00000000, 0200000E)  
 Dataset 3: CCHH=(20000000, 2200000E)

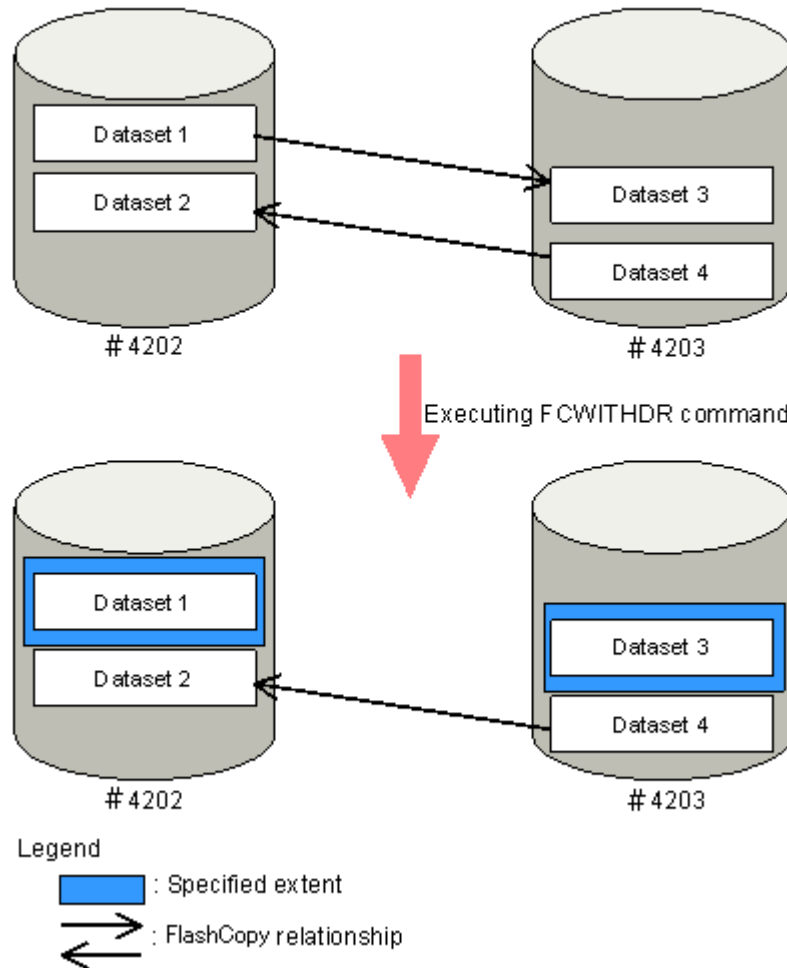

**Figure 29 Case 2: FCWITHDR command (TDEVN specified, DDSW = NO, XTNTLST specified)**

Another example for Case 2 follows. This example requests the withdrawal of all relationships established with target extents included in the specified extents on device 4203. In this example, only part of Dataset 3 is specified by XTNTLST.

```
FCWITHDR TDEVN(X'4203') XTNTLST(X'00000000' X'
0000000E' X'20000000' X' 2000000E')
```

When the command is executed, the relationship established with the specified target, Dataset 3, is not withdrawn because the specified extent on device 4203 is only a part of Dataset 3.

Dataset 1: CCHH=(00000000,0200000E)  
 Dataset 3: CCHH=(20000000,2200000E)

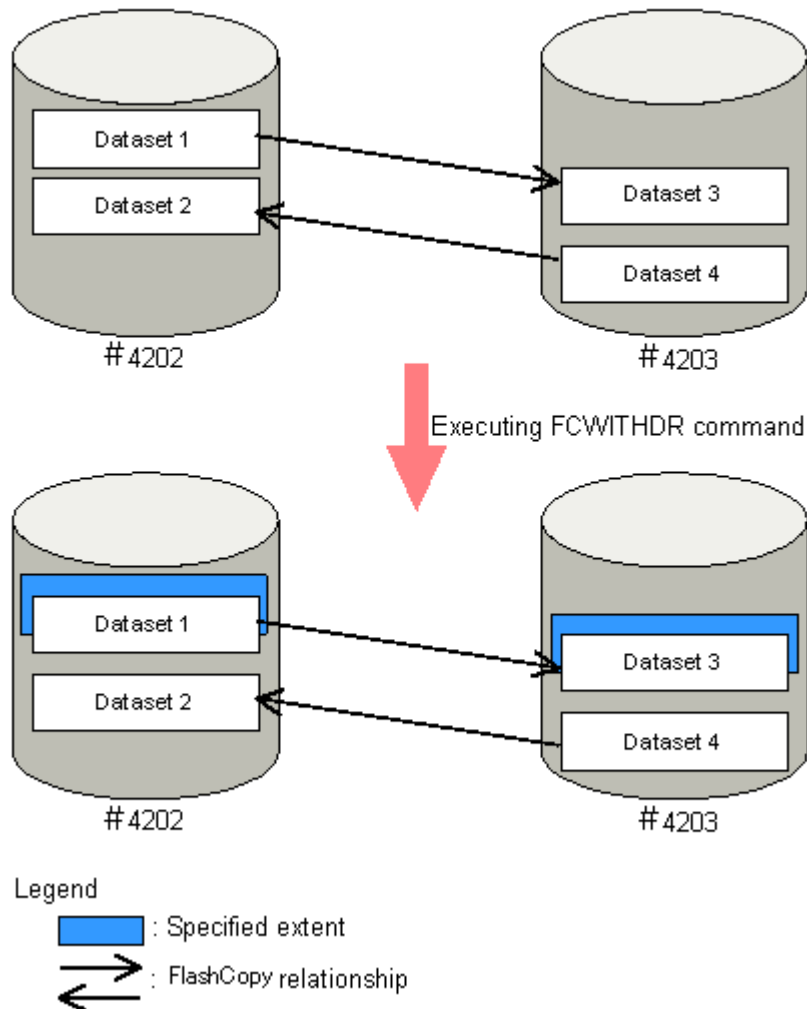

**Figure 30 FCWITHDR command (TDEVN: specified, DDSW = NO, XTNTLST or XXTNTLST specified)**

### Case 3: SDEVN and TDEVN specified, DDSW = NO

All of the relationships established between the source device specified by SDEVN and the target device specified by TDEVN are withdrawn.

An example for Case 3 follows. This example requests the withdrawal of all relationships established with device 4202 as the source and device 4203 as the target.

```
FCWITHDR SDEVN(X'4202') TDEVN(X'4203')
```

In this case, only the relationships established with Dataset 3 in device 4203 are relevant. When the **FCWITHDR** command is executed, the relationship established with Dataset 3 is withdrawn. Dataset 6 is not withdrawn because

the source volume is 4204. There are three relationships before the **FCWITHDR** command is executed and two relationships after the **FCWITHDR** command is executed.

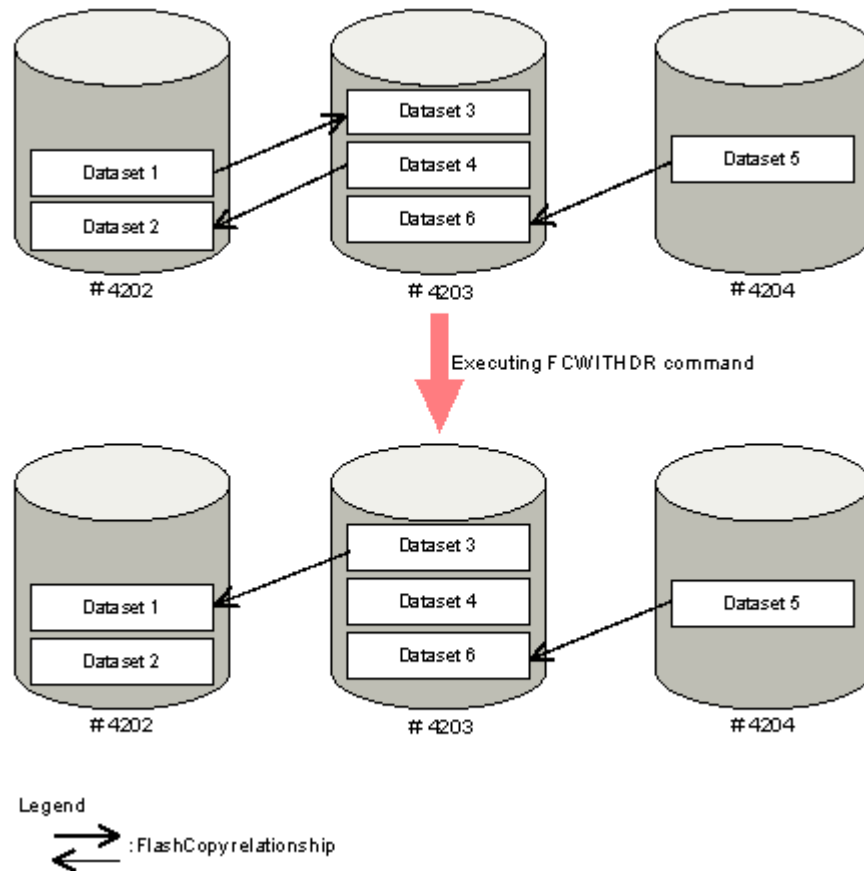

**Figure 31 Case 3: FCWITHDR command (SDEVN and TDEVN specified, DDSW = NO)**

**Case 4: SDEVN and TDEVN specified, DDSW = NO, XTNTLST or XXTNTLST parameter specified**

Relationships between the specified source device (SDEVN) and target device (TDEVN) that are included inside the specified extent ranges for the source and target by the XTNTLST or XXTNTLST parameter are withdrawn. If only part of an extent is specified in XTNTLST or XXTNTLST, the relationship that includes that extent is not withdrawn.

When the following **FCWITHDR** command is executed and the extent specified by the XTNTLST or XXTNTLST parameter does not include an established relationship, the command does nothing and ends normally.

The following command requests the withdrawal of relationships established with the source extent on device 4202 and the target extent on device 4203.

```
FCWITHDR SDEVN(X'4202') TDEVN(X'4203')
XTNTLST(X'00000000' X'0300000E' X'20000000'
X'2300000E')
```

In this case, the specified extent on device 4202 includes all of Dataset 1 and the specified extent on device 4203 includes all of Dataset 3. When the **FCWITHDR** command is executed, the relationship for Dataset 1 is withdrawn. There are two relationships before the **FCWITHDR** command is executed and only one relationship after the **FCWITHDR** command is executed.

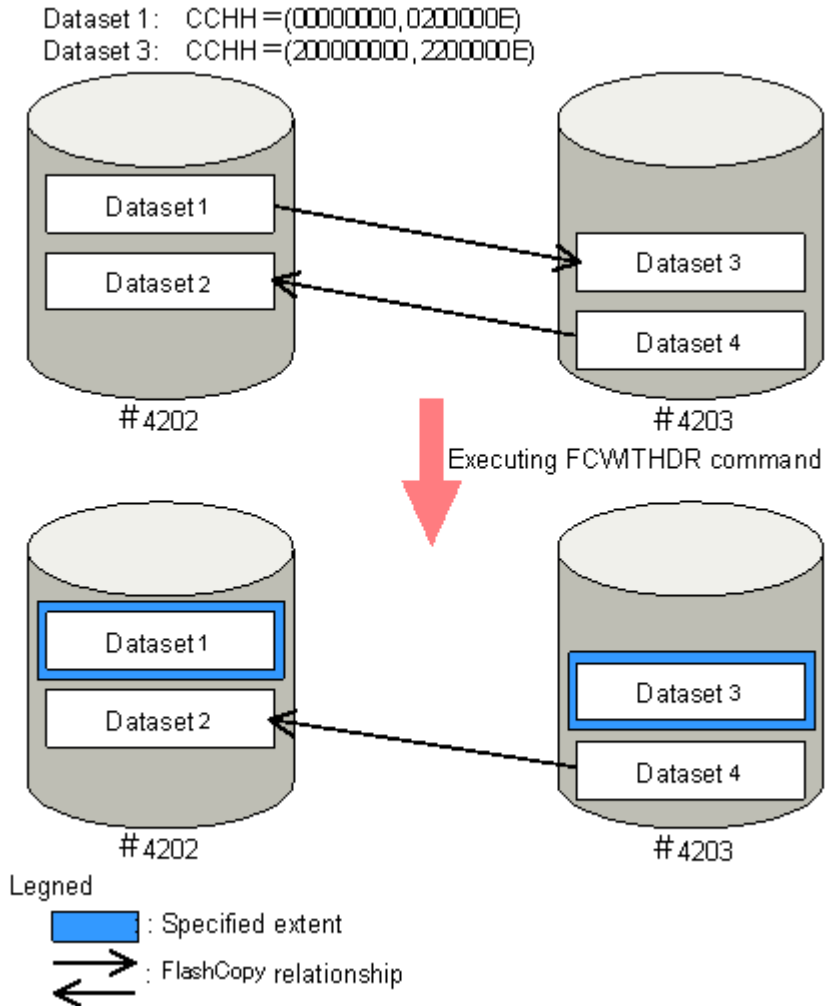
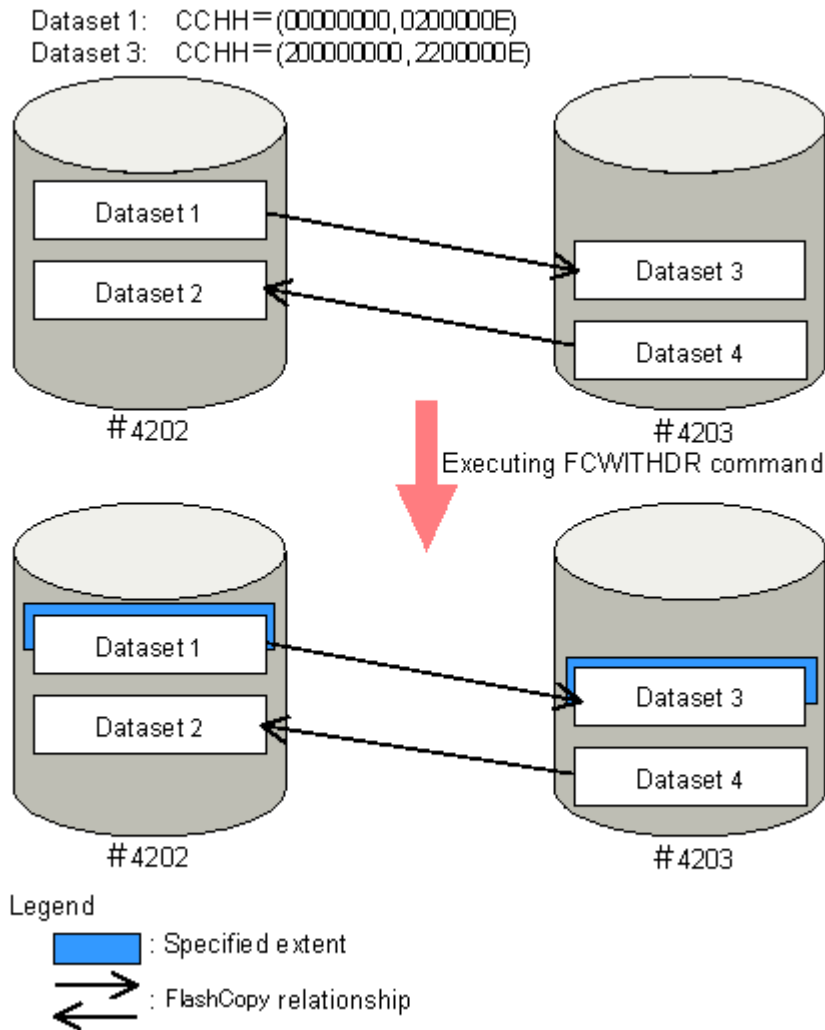

**Figure 32 Case 4: FCWITHDR command (SDEVN and TDEVN specified, DDSW = NO, XTNTLST or XXTNTLST specified)**

Another example for Case 4 follows. This example requests the withdrawal of relationships with the source extent on device 4202 and the target extent on device 4203.

```
FCWITHDR SDEVN(X'4202') TDEVN(X'4203')
XTNTLST(X'00000000' X'0300000E' X'20000000'
X' 2000000E')
```

When you execute this **FCWITHDR** command, the relationship established for Dataset 1 is not withdrawn because the specified extent on device 4202 is included as a part of Dataset 1.



**Figure 33 Case 4: FCWITHDR command (SDEVN and TDEVN specified, DDSW = NO, XTNTLST or XXTNTLST specified, partial dataset specified)**

Another example for Case 4 follows. In this example, the extent specified by the XTNTLST or XXTNTLST parameter is located in the center of Dataset 1,

and the specified extent on device 4202 is included as a part of Dataset 1. In this case, the relationship established for Dataset 1 is not withdrawn.

```
FCWITHDR SDEVN(X'4202') TDEVN(X'4203')
XTNTLST(X'01000000' X'0100000E' X'21000000'
X'2100000E')
```

### Case 5: SDEVN and TDEVN specified or not specified, DDSW = YES

All relationships established with the source or target extents on the device specified by SDEVN are withdrawn.

If the device specified by SDEVN is a relationship using COPY mode, the relationship is withdrawn after the background copy operation completes.

If the device specified by SDEVN is a relationship source using NOCOPY mode, the relationship is withdrawn after the copy mode is changed to COPY and the background copy operation completes. If the device specified by SDEVN contains the target of a relationship, the relationship is withdrawn immediately. If the device specified by SDEVN has a source relationship established with INCREMENTAL = YES, the relationship will be maintained after the background copy operation completes. The setting on the device specified by TDEVN (if specified) is ignored.

When YES is selected for the DDSW parameter, the TDEVN parameter (if specified) is ignored. The following two examples show the same command action with and without the TDEVN parameter. Both examples request the withdrawal of all relationships established with device 4202.

```
FCWITHDR SDEVN(X'4202') DDSW(YES)
FCWITHDR SDEVN(X'4202') TDEVN(X'4203') DDSW(YES)
```

Since the TDEVN parameter is ignored if it is specified, both command examples cause the relationships for Dataset 1 and Dataset 2 to be withdrawn because they are on device 4202. As a result, there are no longer any relationships established for device 4202 after this command is executed.

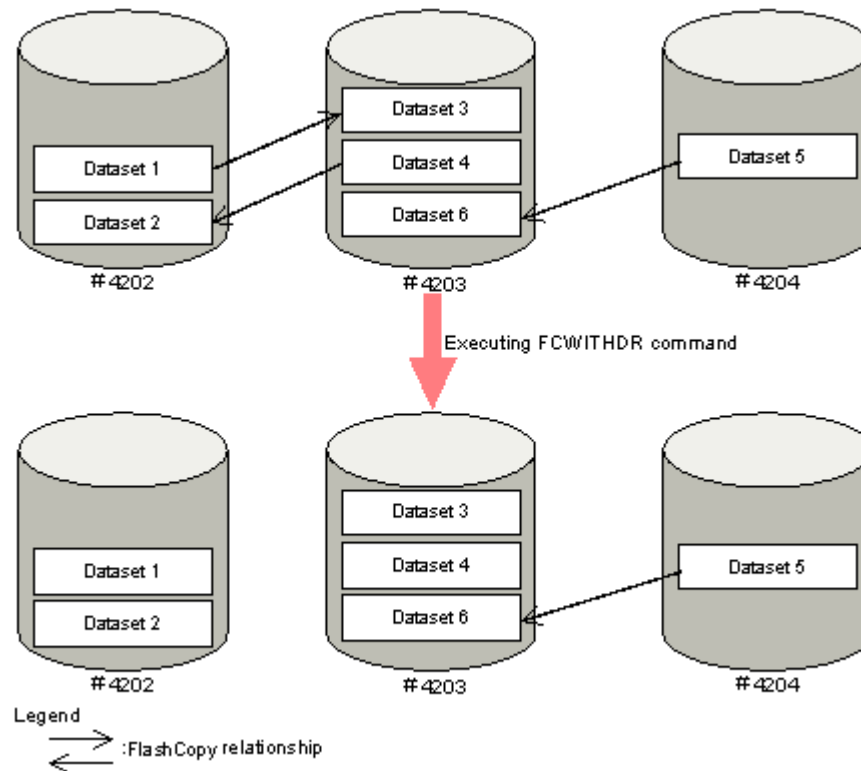

**Figure 34 Case 5: FCWITHDR command (SDEVN and TDEVN specified, DDSW = YES)**

### Case 6: SDEVN and TDEVN specified or not specified, DDSW = YES, XTNTLST or XXTNTLST parameter specified

For relationships established with the device specified by SDEVN:

- All relationships with extents partly or entirely included in the extents specified by the XTNTLST or XXTNTLST parameter are withdrawn.
- The TDEVN and the target extents specified by the XTNTLST or XXTNTLST parameter are ignored.

When the **FCWITHDR** command is executed with **DDSW = YES** and the **XTNTLST** or **XXTNTLST** parameter is specified, only the **XTNTLST** or **XXTNTLST** parameter values specified for the source extent are used. When no relationships exist within the source extent that is specified by the **XTNTLST** or **XXTNTLST** parameter values, the **FCWITHDR** command does nothing and ends normally.

The following two **FCWITHDR** command examples show how the **TDEVN** parameter is ignored if it is specified. Both examples request the withdrawal of all relationships established with device 4202 that exist inside the extent range specified by the **XTNTLST** or **XXTNTLST** parameter. When **DDSW = YES**, the **TDEVN** parameter value and the **XTNLST** or **XXTNTLST** parameter value

for the target extent are ignored. Therefore, the two commands in the example cause the same result.

```
FCWITHDR SDEVN(X'4202') DDSW(YES) XTNTLST(X'01000000'
X'1100000E' X'21000000' X'2200000E')
FCWITHDR SDEVN(X'4202') TDEVN(X'4203') DDSW(YES)
XTNTLST(X'01000000' X'1100000E' X'21000000' X'2200000E')
```

Before the **FCWITHDR** command in the example above is executed, there are three relationships, and there is only one relationship after the command is executed.

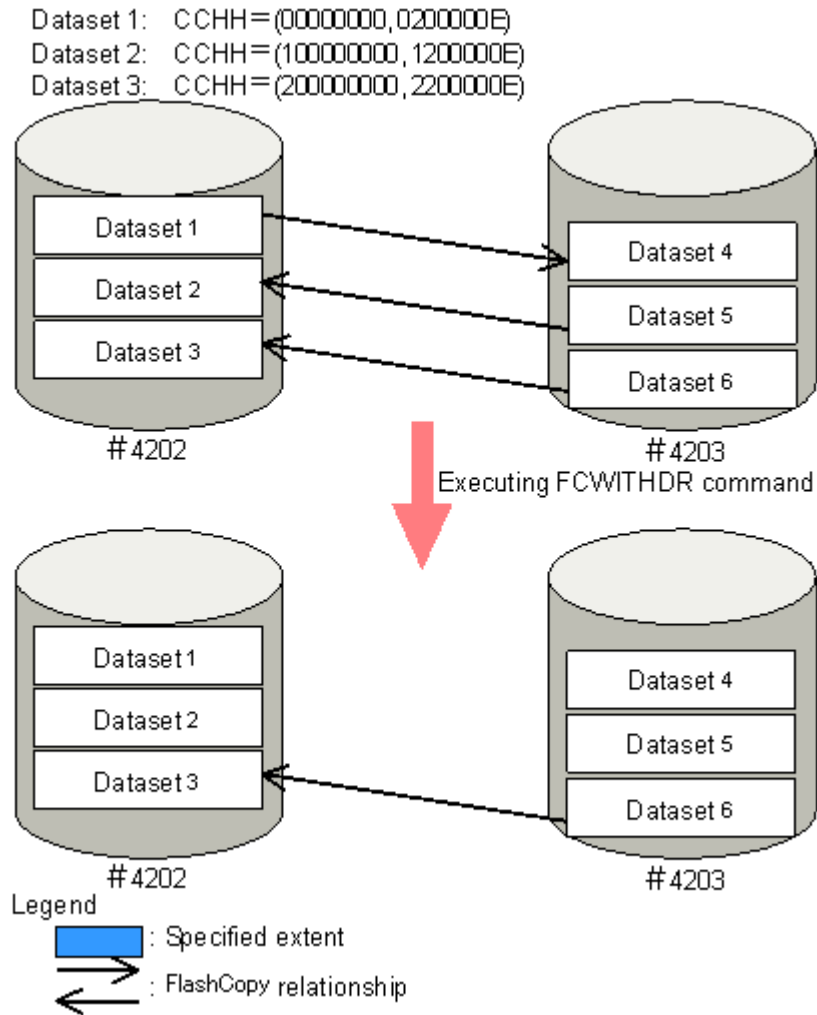

**Figure 35 Case 6: FCWITHDR command (SDEVN and TDEVN specified, DDSW = YES, XTNTLST specified)**

**Case 7: DEVN specified, ACTION = THAW**

Resume write operations to the volumes that belong to the CU specified by the DEVN parameter. Relationships are not withdrawn.

The following example shows the command to resume write operations to the volumes that belong to the CU that contains device 4202.

```
FCWITHDR DEVN(X'4202') ACTION(THAW)
```

Since no relationship is withdrawn by performing this command, there is no change in the number of relationships after the command is executed.

Even if you do not issue this command, write operations to the volumes may be resumed implicitly if the SCP time elapses.

## USING ICKDSF to release Compatible FlashCopy® V2 relationships

The following table shows the parameters that you can use with the `ICKDSF` command when you release Compatible FlashCopy® V2 relationships:

**Table 42 Parameters for the ICKDSF command (FLASHCPY WITHDRAW)**

Parameter	Value	Description
DDNAME or DNAME	JCL statement	Specifies the JCL statement identifying the volume. If the OS of the host server is z/OS®, this parameter or the UNITADDRESS parameter is required.
SYSNAME	SYSNAME	Specifies the SYSNAME in the ASSGN system control statement. If the OS of the host server is VSE, this parameter is required.
UNITADDRESS, UNITADDR, or UNIT	Source device number	Specifies the device number (device address) of the S-VOL on which you want to perform the <code>FLASHCPY WITHDRAW</code> command. If the OS of the host server is z/OS®, this parameter or the DDNAME parameter is required.
TARGETVOL or TGTVOL	CU number LDEV number Target device number	Specifies the CU number, LDEV number, and device number (device address) of the T-VOL on which you want to perform the <code>FLASHCPY WITHDRAW</code> command. This parameter is required. The Target device number is required only in certain situations. See the <i>IBM® Device Support Facilities (ICKDSF)</i> manual for more information.
MODE	COPY	Executes a background copy operation for all source relationships existing for the volume specified in the DDNAME, SYSNAME, or UNITADDRESS parameter. If YES is specified for CHANGERECORDING when creating the relationship, the relationship will be maintained after the background copying operation is completed. If NO or nothing is specified for CHANGERECORDING when creating the relationship, the relationship will be withdrawn after the background copying operation completes.
	NOCOPY	Deletes all source relationships for the specified source volume and specified target volume.  NOCOPY is the default setting.

Parameter	Value	Description
	ALL	Performs the same actions as MODE(COPY) and also withdraws all target relations on the addressed volume.
RESETGTWRTINHIBIT, RESETGTWRTINHB, or RTWI	No value required	Permits write operations to the T-VOL. The relationship is not deleted.
SOURCEVOL or SRCVOL	CU number LDEV number SSID Serial number Source device number	This parameter is required only when the Compatible FlashCopy® V2 source volume is a PPRC secondary volume of the device identified by the DDNAME, SYSNAME, or UNITADDRESS parameter. It specifies the CU number, LDEV number, and SSID of the Compatible FlashCopy® V2 source volume, the serial number of the storage system containing the Compatible FlashCopy® V2 source volume, and the device number of the source volume. The device number is required only in specific situations. See the <i>IBM® Device Support Facilities (ICKDSF)</i> manual.
FORCE	YES	Releases the relationship established by the Preserve Mirror FlashCopy® function without executing the background copy operation. Releases the relationship defined to the copy target.
	NO	Releases the relationship established by the Preserve Mirror FlashCopy® function after the background copy operation completes.  NO is the default setting.
RELATSPACE*	No value required	If the T-VOL is a TSE-VOL, the physical capacity of the allocated TSE-VOL is released.

\*Valid only for Compatible FlashCopy® SE.

## Using FLASHCPY WITHDRAW to release Compatible FlashCopy® V2 relationships

The **FLASHCPY WITHDRAW** command usage defines specific combinations of parameters that are allowed. If you specify a parameter combination that is not allowed, the **FLASHCPY WITHDRAW** command terminates normally without performing any action.

The following table shows the **FLASHCPY WITHDRAW** parameters and applicable combinations.

**Table 43 Parameters of FLASHCPY WITHDRAW command and applicable combinations**

Parameter				Background copying
DDNAME, SYSNAME, UNITADDRESS	TARGETVOL	MODE	Executed	Relationship after completion
S-VOL	T-VOL or some other volume	COPY	Yes	Maintained when CHANGERECORDING = YES  Released when CHANGERECORDING = NO

Parameter				Background copying
DDNAME, SYSNAME, UNITADDRESS	TARGETVOL	MODE	Executed	Relationship after completion
S-VOL	T-VOL	NOCOPY or not specified	No	Released
S-VOL	T-VOL or some other volume	ALL	Yes	Maintained when CHANGERECORDING = YES Released when CHANGERECORDING = NO
T-VOL	S-VOL or some other volume	ALL	No	Released

### Procedure

1. If the host is running z/OS®, do one of the following:
  - Specify the name on the JCL DD statement that defines the source volume in the DDNAME parameter.
  - Specify the S-VOL device number of the relationship that you want to delete for the UNITADDRESS parameter.
2. If the host is running VSE, specify the SYSNAME of the ASSGN system control statement in the SYSNAME parameter.
3. In the TARGETVOL parameter, specify the CU number, LDEV number, and device number (if required) of the T-VOL.
4. As shown in the following table, specify any other necessary parameters and execute the **FLASHCPY WITHDRAW** command as shown in the following example:

```
FLASHCPY WITHDRAW UNIT(X'7000') TARGETVOL(X'00',X'01',7001)
MODE(COPY)
```

ICKDSF supports only the creation of full volume relationships. However, the **FLASHCPY WITHDRAW** command causes both full volume and dataset (for example, extent) relationships to be withdrawn.

## Using ANTRQST macro to release Compatible FlashCopy® V2 relationships

The following table shows the parameters that you use with the **ANTRQST** macro when you release Compatible FlashCopy® V2 relationships.

**Table 44 Parameters for the ANTRQST macro (REQUEST=FCWITHDRAW)**

Parameter	Value	Description
SDEVN	Source device number	Specifies the device number (device address) of the S-VOL that you want to use for the withdraw.

Parameter	Value	Description
TDEVN	Target device number	Specifies the device number (device address) of the T-VOL that you want to use for the withdraw.
DEVN	Device number	Specifies the device number that you want to use when the ACTION parameter is specified.
ACTION	THAW	Resumes write operations from the host to all volumes that belong to the same CU as the device specified by the DEVN parameter.
RETINFO	Return value	Obtains the return code and the reason code of the execution results. For details about the codes, see the <i>IBM® z/OS® DFSMS Advanced Copy Services manual</i> .
DDSW	YES	The relationships established on the volume specified as the source by SDEVN are withdrawn. The relationships are withdrawn after a background copy is completed for each relationship.
	NO	The DDSW function is ignored, and the macro causes action based on other parameters.  NO is the default setting.
SRCEXTENTS	Copy source extent (copy range)	Specifies one or more extent ranges in CCHH format for the source volume to use in determining the source relationships on which to perform the withdraw action. Up to 32 extents can be specified. When SRCEXTENTS is not specified, the relationships on all tracks are withdrawn.
TGTEXTENTS	Copy target extent (copy range)	Specifies one or more extent ranges in CCHH format for the target volume to use in determining the source relationships on which to perform the withdraw action. Up to 32 extents can be specified. When TGTEXTENTS is not specified, the relationships on all tracks are withdrawn.
TGTUCB	YES	Specifies the device number (device address) of the T-VOL on which you want to perform the <b>FCWITHDRAW</b> command. To specify this number, use the TDEVN parameter.  YES is the default setting.
	NO	Specifies the device number will not be used for the target device (for example, TDEVN is not used). To specify the target device, use the TGTSERIAL, TGTLSS, and TGTDVC parameters instead of TDEVN.
TGTSERIAL	Serial number	Specifies the storage system serial number for the T-VOL on which you want to perform the <b>FCWITHDRAW</b> command. Use this parameter when the TGTUCB parameter is NO.
TGTLSS	LSS	Specifies the LSS (CU number) of the T-VOL on which you want to perform the <b>FCWITHDRAW</b> command. Use this parameter when the TGTUCB parameter is NO.
TGTDVC	CCA	Specifies the CCA (LDEV number) of the T-VOL on which you want to perform the <b>FCWITHDRAW</b> command. Use this parameter when the TGTUCB parameter is NO.

## Using z/VM CP FLASHCOPY WITHDRAW to release Compatible FlashCopy® V2 relationships

A relationship established using the z/VM **FLASHCOPY ESTABLISH** command is not released after the background copy is completed.

To release a Compatible FlashCopy® V2 relationship, use the **FLASHCOPY WITHDRAW** command.

The following table shows the parameters that are available with the **FLASHCOPY WITHDRAW** command.

**Table 45 Parameters for the FLASHCOPY WITHDRAW command**

Parameter	Value	Description
SOURCE	Primary device number Starting cylinder of source Ending cylinder of source	Specifies the virtual device number (device address or mini disk number), the starting cylinder, and the ending cylinder of the copy source.
TARGET	Secondary device number Starting cylinder of target Ending cylinder of target	Specifies the virtual device number (device address or mini disk number), the starting cylinder, and the ending cylinder of the copy destination. Up to 110 extents of copy target can be specified.
FORCE	-	The relationship can be immediately cancelled even if the background copy is not completed.



# Performing Compatible FlashCopy® SE operations

This chapter provides an overview, best practices, and requirements for Compatible FlashCopy® SE.

- [Overview of Compatible FlashCopy SE](#)
- [Best practice for using Compatible FlashCopy SE](#)
- [Requirements for using Compatible FlashCopy SE](#)
- [Creating pools](#)
- [Creating TSE-VOLs for Compatible FlashCopy SE](#)
- [Pool operations and TSE-VOLS](#)
- [Sharing a pool with DP-VOL](#)
- [Establishing HCFCSE relationships](#)
- [Viewing HCFCSE relationship states](#)
- [Releasing HCFCSE relationships](#)
- [Viewing TSE-VOL or pool information using the IDCAMS LISTDATA command](#)

## Overview of Compatible FlashCopy® SE

Compatible FlashCopy® SE (HCFE) reduces the physical volume size of the T-VOL by using a TSE-VOL thin-provisioned virtual volume as the FlashCopy® T-VOL.

Before using HCFE, you must install HCFE and Dynamic Provisioning for Mainframe in the storage system.

You establish HCFE volume relationships by issuing commands from any of the following mainframe host interfaces:

- PPRC TSO
- DFSMSdss
- ICKDSF
- ANTRQST macro
- z/VM CP

The following table describes the functionality supported by HCFE.

**Table 46 Functions supported by Compatible FlashCopy SE**

Action	Functionality	Description
Establishing relationships	Volume copy	Copies S-VOL updates to the T-VOL. This function does not perform a background copy. If a relationship established in NOCOPY mode is deleted, the data on the copy target might be inconsistent.
	Multiple relationships	Supports up to 16 copy targets.
	Using consistency groups for dataset copies	Creates snapshot data consistent across multiple volumes.
	Fast Reverse Restore	Creates a relationship and reverses the S-VOL and T-VOL.
Releasing relationships		Deletes the relationship between the specified S-VOL and T-VOL. Because HCFE operates only in NOCOPY mode, the relationship is deleted immediately after you execute the withdraw command. When you execute the withdraw command, you can specify whether or not to release already allocated areas.
Displaying relationship status		You can view relationship status using a host command or Device Manager - Storage Navigator.

## Best practice for using Compatible FlashCopy® SE

The best practice for using HCFE is to save data temporarily for short-term requirements such as staging backup to tape or other media.

You must initialize a TSE-VOL before using it.

Since HCFCSE operates only in NOCOPY mode, the consistency of the T-VOL (TSE-VOL) data cannot be ensured when a relationship is withdrawn before a copy operation on the T-VOL completes. Do not perform I/O operations to the TSE-VOL after the HCFCSE relationship is withdrawn.

## Requirements for using Compatible FlashCopy® SE

The following table describes requirements for using HCFCSE.

**Table 47 Requirements for using Compatible FlashCopy SE**

Item	Requirement
Controller emulation type	I-2107
Available volume	HCFCSE can use volumes whose LDKC:CU:LDEV is between 00:00:00 and 00:FE:FF.  You can only establish a Compatible FlashCopy® SE relationship for Simplex (unpaired) volumes.  Use TSE-VOLs as target volumes.

## Creating pools

This section describes how to create pools.

### Before you begin

You must have the Storage Administrator (Provisioning) role.

### Procedure

1. Open the **Create Pools** window.
  - a. Click **Storage Systems**, and then expand the **Storage Systems** tree.
  - b. Click **Pools**.
  - c. Click **Create Pools**.
2. From the **Pool Type** list, select **Dynamic Provisioning**.
3. From the **System Type** list, select **Mainframe**.
4. From the **Multi-Tier Pool** field, select **Disable**.
5. From the **Pool Volume Selection** field, select **Manual**.
6. Take the following steps to select pool-VOLs:
  - a. From the **Drive Type/RPM** list, select the data drive type and RPM.
  - b. From the **RAID Level** list, select the RAID level.  
If you select **External Storage** from the **Drive Type/RPM** list, a hyphen (-) appears and you cannot select the RAID level.

c. Click **Select Pool VOLs**.

The **Select Pool VOLs** window appears.

d. In the **Available Pool Volumes** table, select the pool-VOL row to be associated with a pool. Then, click **Add**.

You can select a value other than **Middle** from **External LDEV Tier Rank**, and you can click **Add** to set another tier rank for an external volume.

The selected pool-VOL is registered in the **Selected Pool Volumes** table. Up to 1,024 volumes can be added to a pool.



**Tip:** Perform the following steps if necessary:

- Click **Filter** to open the menu, specify the filtering conditions, and then click **Apply**.
  - Click **Select All Pages** to select all pool-VOLs in the table. To cancel the selection, click **Select All Pages** again.
  - Click **Options** to specify the volumes or the number of rows to be displayed.
- 

e. Click **OK**.

The information in the **Selected Pool Volumes** table is applied to **Total Selected Pool Volumes** and **Total Selected Capacity**.

7. Enter the name in the **Pool Name** text box.

Enter a maximum of 32 alphanumeric characters. The name is case sensitive.

8. Click **Options**.

9. In the **Initial Pool ID** text box, type the number of the initial pool ID, from 0 to 127.

When you specify a pool ID that was previously registered, the smallest available ID is displayed by default instead of the value you entered. If a pool ID is unavailable, no number is displayed.

10. In the **Subscription Limit** text box, enter an integer value from 0 to 65534 as the subscription rate (%) for the pool.

If no number is entered, the subscription rate is set to unlimited.

11. In the **Warning Threshold** text box, enter an integer value from 1 to 100 as the rate (%) for the pool. The default value is 70%.

12. In the **Depletion Threshold** text box, enter an integer value from 1 to 100 as the rate (%) for the pool. The default value is 80%.

Enter a value that is equal to or greater than the value of the **Warning Threshold**.

13. Click **Add**.

The created pool is added to the **Selected Pools** table. If invalid values are set, an error message appears.

The **Pool Type**, **Pool Volume Selection**, and **Pool Name** must be set. If the required items are not entered or selected, you cannot click **Add**.

If you select a row and click **Detail**, the **Pool Properties** window appears. If you select a row and click **Remove**, the message appears asking whether you want to remove the selected row or rows. If you want to remove the row, click **OK**.

**14.** Click **Next**.

The **Create LDEVs** window appears. Go to [Creating TSE-VOLs for Compatible FlashCopy SE on page 139](#) to create LDEVs.

If the pool ID is even, you can only create LDEV TSE-VOLs that have even CU numbers. If the pool ID is odd, you can only create LDEV TSE-VOLs that have odd CU numbers.

If **Subscription Limit** of the created pool is set to 0%, the **Create LDEVs** window does not appear.

Click **Finish** and the **Confirmation** window appears.

**15.** In the **Confirmation** window, check the settings and then enter the task name in **Task Name**. Select the pool radio button and click **Details**.

The **Pool Properties** window appears.

**16.** Click **Apply**. The tasks are registered.

If the **Go to tasks window for status** check box is selected, the **Tasks** window appears.

## Creating TSE-VOLs for Compatible FlashCopy® SE

After you create a TSE-VOL, the volume is in the blocked status. In order to use the TSE-VOL, you must format the TSE-VOL LDEV and initialize the volume. Formatting the LDEV creates six or twelve pages (depending on the volume size) of control information.

### Before you begin

- You must have the Storage Administrator (Local Copy) role.
- The Dynamic Provisioning for Mainframe pool that you select to provision a TSE-VOL must be in one of following states:
  - Normal
  - Exceeded Threshold
  - Shrinking

Use the **Create Pools** window in Device Manager - Storage Navigator to create Dynamic Provisioning for Mainframe pools and view pool status. For instructions, see the *Provisioning Guide for Mainframe Systems*.

### Procedure

- 1.** Open the **Create LDEVs** window.
  - a. In the Device Manager - Storage Navigator main window, select **Logical Devices**, and then click the **LDEVs** tab.
  - b. Click **Create LDEVs**.
- 2.** In the **Create LDEVs** window, enter the following settings:

Item	Setting for TSE-VOLs
Provisioning Type*	Dynamic Provisioning
System Type*	Mainframe
Emulation Type*	3390-A
Multi-Tier Pool	Disable
TSE Attribute	Enable
Pool Selection*	<p>Select the pool for the new TSE-VOLs.</p> <ol style="list-style-type: none"> <li>From the <b>Drive Type/RPM</b> list in <b>Pool Selection</b>, select the data drive type and RPM.</li> <li>From the <b>RAID level</b> list, select the RAID level.</li> <li>Click <b>Select Pool</b>. The <b>Select Pool</b> window opens.</li> <li>In the <b>Available Pools</b> table, select a pool.</li> <li>Click <b>OK</b>. The <b>Select Pool</b> window closes. The selected pool name appears in <b>Selected Pool Name</b>, and the total capacity of the selected pool appears in <b>Selected Pool Capacity</b>.</li> </ol>
LDEV Capacity*	Enter the capacity of each TSE-VOL to be created.
Number of LDEVs*	Enter the number of TSE-VOLs to be created.
LDEV Name	<p>Optional. Enter the names of the TSE-VOLs to be created. You can enter up to 32 characters, including the prefix characters and initial number. This is useful for tracking the LDEVs in the storage system that are TSE-VOLs.</p> <ul style="list-style-type: none"> <li><b>Prefix:</b> Enter the alphanumeric characters that are the fixed characters of the head of the LDEV name. The characters are case sensitive.</li> <li><b>Initial Number:</b> Enter the initial number (up to 9 digits) following the prefix name.</li> </ul>
Option	<p>Set these options for new TSE-VOLs:</p> <ul style="list-style-type: none"> <li>In <b>Initial LDEV ID</b>, set the values for the CU and one or more LDEVs to be created. To view the used and available CU:LDEV addresses, click <b>View LDEV IDs</b>.</li> <li>In <b>Initial SSID</b>, type the 4-digit SSID hexadecimal number (0004 to FFFE). To confirm the created SSID, click <b>View SSID</b>. If you create LDEVs in an existing CU, the SSID for the new volumes will be the same as the existing volumes in the CU if the specified SSID value does not match.</li> </ul>
Cache Partition	CLPR
Processor Blade	Select the processor blade for the new TSE-VOLs.
*Required	

- After you enter the settings for the TSE-VOLs, click **Add**.  
The TSE-VOLs to be created move to the **Selected LDEVs** table. If you set invalid values, an error message is displayed.
- (Optional) Review the list of TSE-VOLs in the **Selected LDEVs** table. If necessary, you can change the following settings:
  - SSID:** Click **Edit SSIDs** in the **SSIDs** window and edit the SSIDs. For instructions, see the *Provisioning Guide for Mainframe Systems*.

- LDEV settings: Click **Change LDEV Settings** and edit the LDEV settings in the **Change LDEV Settings** window. For instructions, see the *Provisioning Guide for Mainframe Systems*.
5. (Optional) If you want to remove an LDEV from the **Selected LDEVs** table, select the LDEV, and then click **Remove**.
  6. When you are ready to create the TSE-VOLs listed in the **Selected LDEVs** table, click **Finish**.  
The **Confirm** window opens.
  7. Enter a **Task Name**, and then click **Apply**.  
If you selected **Go to tasks window for status**, the **Task** window opens when the task begins.

## Pool operations and TSE-VOLS

### Operations when a pool is full

Space is allocated to thin provisioned volumes in units of pages by Dynamic Provisioning for Mainframe. Space is allocated to a TSE-VOL on a track basis inside an allocated page. Even if the pool becomes full, data updated on the HCFCSE S-VOL will be copied to the T-VOL as long as the pages allocated to the TSE-VOL being used as the HCFCSE T-VOL have tracks available.

When the target location is not allocated and there is no space available on the T-VOL page, read and write operations cannot be performed. However, if the target location has already been allocated, read operations can be performed. When there is no space available to allocate a new page for write operations on the S-VOL, copy operations to the T-VOL fail and the relationship enters the failed state. The failed state causes all read and write operations to the T-VOL to fail. To recover from the failed state, you must release the relationship.

Even if the pool is completely full (no pages available to allocate to V-VOLs), you can create a relationship in which the T-VOL is a TSE-VOL. However, if you attempt to write to the S-VOL for the relationship, the relationship enters the failed state.

### Managing failed states

When a pool does not have physical capacity available to allocate new pages to TSE-VOLs, the copy operation from the HCFCSE S-VOL to the HCFCSE T-VOL fails when the S-VOL is updated. Once the HCFCSE relationship is in the failed state, all read and write operations to the T-VOL will fail until the relationship is released and re-established. Update operations to the S-VOL continue, but updated data is not copied to the T-VOL.

To recover an HCFCSE relationship from a failed state, you must release the relationship.

## Pool capacity warning to the host

When the used capacity of a pool that provisions a TSE-VOL exceeds the user-defined threshold value, a warning message is issued to the host.

Examples of warning messages follow:

- If the user sets the warning threshold to 70%, and the pool usage capacity exceeds this threshold, the following warning message is issued:  
REPOSITORY VOLUME WARNING: AT 30% CAPACITY REMAINING
- If the user sets the exhaustion threshold to 80%, and the pool usage capacity exceeds this threshold, the following warning message is issued:  
REPOSITORY VOLUME WARNING: AT 20% CAPACITY REMAINING
- If the pool usage rate reaches 100%, the following warning message is issued:  
REPOSITORY VOLUME EXHAUSTED

The above messages are issued when the threshold is reached regardless of the number of HCFCSE relationships that exist when an I/O operation is performed to a single TSE-VOL.

Messages are reported to all hosts that have one of the volumes online that is running out of space. If a host has more than one of these volumes online, only one of the volumes is mentioned in the message.

- TSE-VOL (HCFCSE target volume or volume in Simplex status) associated with the pool
- Source volume in a HCFCSE relationship

## Sharing a pool with DP-VOL

TSE-VOLs and DP-VOLs can be assigned to the same pool. However, if DP-VOL and TSE-VOL share a pool, the capacity of the pool must be designed by estimating the combined capacity of the DP-VOLs and TSE-VOLs.

## Establishing HCFCSE relationships

### Maintaining data consistency

When you use the **FCESTABL** command to establish HCFCSE relationships, you can maintain data consistency by using the ACTION parameter to suspend write operations to S-VOLs. The ACTION parameter is described in the following table.

**Table 48 ACTION parameter to the FCESTABL command (HCFCSE / Suspending write operations to S-VOLs)**

Parameter	Value	Description
ACTION	FREEZE	Suspends write operations from the host to S-VOLs. If you establish a relationship and specify extents, the ACTION parameter suspends write operations to the volume.

The following example shows how to use the **FCESTABL** command to suspend write operations to an S-VOL when you establish a HCFCSE relationship. In this example, the **FCESTABL** command creates a relationship between devices 4202 and 4203, and at the same time suspends write operations from the host to the source device numbered 4202.

```
FCESTABL SDEVN(X'4202') TDEVN(X'4203') ACTION(FREEZE)
SETGTOK(YES) MODE(NOCOPY)
```

To resume writing to S-VOLs, issue the **FCWITHDR** command with the ACTION parameter specified.

If a timeout occurs before you issue the **FCWITHDR** command, write operations resume. The default setting for the timeout is 120 seconds (2 minutes).



**Caution:** The SCP time for HCFCSE and TCz is the same. Therefore, when you change the SCP time for HCFCSE, you must specify a value for the SCP time considering the SCP requirements for TCz as well. For information about the SCP time for TCz, see the *Hitachi TrueCopy® for Mainframe User Guide*.

## Commands for establishing HCFCSE relationships

To establish HCFCSE relationships, use any of the following types of commands:

- PPRC TSO
- DFSMSdss
- ICKDSF
- z/VM CP

## Using PPRC TSO to establish HCFCSE relationships

### Procedure

1. Always specify FCSETGTOK(YES) and MODE(NOCOPY), and then execute the **FCESTABL** command.  
The EXTENTS, XTNTLST, and XXTNTLST parameters cannot be specified for HCFCSE.
2. Change the VOLSER of the T-VOL.

Before you vary the T-VOL online to an LPAR that has the S-VOL online, you must change the VOLSER of the T-VOL. When the VTOC is copied, the VOLSER of the S-VOL and the T-VOL become identical, so this step is necessary before varying the T-VOL online.

In the following example, the **FCESTABL** command establishes a relationship to copy the data from a source device, numbered 4202, to a target device, numbered 4203. This relationship is established in NOCOPY mode after 4203 is offline.

```
FCESTABL SDEVN (X'4202') TDEVN (X'4203') MODE (NOCOPY) SETGTOK  
(YES)
```

## Using DFSMSdss to establish HCFSE relationships

The DFSMSdss copy command is used to process HCFSE volume copy operations. The FCSETGTOK and FCNOCOPY parameters must be specified when performing HCFSE operations.

DFSMSdss processes the **COPY FULL** command in a few seconds and establishes the HCFSE relationship simultaneously as it completes the processing. The job completion is not reported.

In the following example, a full volume relationship is created between S-VOL FCPY05 and T-VOL FCPY06.

```
//COPY FULL JOB  
//*  
//INSTIMG EXEC PGM=ADRDSSU  
//SYSPRINT DD SYSOUT=*  
//SYSUDUMP DD SYSOUT=V,OUTLIM=3000  
//VOL1 DD UNIT=3390,VOL=SER=FCPY05,DISP=OLD  
//VOL2 DD UNIT=3390,VOL=SER=FCPY06,DISP=OLD  
//SYSIN DD *  
COPY FULL INDYNAM (FCPY05) OUTDYNAM (FCPY06) COPYVOLID  
FCSETGTOK(FAILRELATION) FCNOCOPY  
/*
```

## Using ICKDSF to establish HCFSE relationships

Use the following steps to create a HCFSE relationship using ICKDSF **FLASHCPY ESTABLISH**:

### Procedure

1. Set the T-VOL offline. If the ONLINTGT parameter is set to YES, the T-VOL will automatically be offline when creating relationships.
2. Specify a JCL DD statement to use with the DDNAME parameter, or specify the S-VOL device number in the UNITADDRESS parameter.
3. Specify the CU number, the LDEV number, and the device number of the T-VOL for the TARGETVOL parameter.

4. Execute **FLASHCPY ESTABLISH**.

```
FLASHCPY ESTABLISH UNIT(X'7000') TARGETVOL(X'00',X'01' ,7001)
ONLINTGT(YES) SETGTOK(YES) MODE(NOCOPY)
```

## Using z/VM CP to establish HCFSE relationships

Use the **FLASHCOPY ESTABLISH** command of z/VM CP to establish a HCFSE relationship. The S-VOL and T-VOL must be a whole volume or a full pack mini disk for use with HCFSE.

## Viewing HCFSE relationship states

### Using PPRC TSO FCQUERY to view HCFSE relationship states

Use the **FCQUERY** command to display information such as the attributes of the devices specified by DEVN, and the number of HCFSE relationships established with those specified devices.

The following **FCQUERY** command requests that information be displayed about device 1900.

```
FCQUERY DEVN(1900)
```

The following example shows the information that is displayed by the **FCQUERY** command.

```
QUERY VIRTUAL FLASHCOPY
VDEVN SSID LSS UA CU SERIAL ACTIVE MAX PPRC
0010 0132 02 00 2107 000000048151 1 50099
0020 0132 02 01 2107 000000048151 1 50099
```

When using HCFSE, the information displayed by the **FCQUERY** command is the same as the information shown in the table that describes **FCQUERY** command output in [Using TSO FCQUERY to view Compatible FlashCopy V2 relationship details on page 100](#).

### Using ICKDSF FLASHCPY QUERY RELATIONS to view HCFSE relationship states

To view information about the HCFSE relationships for the specified volume, execute the ICKDSF **FLASHCPY QUERY RELATIONS** command as shown in the following example.

```
FLASHCPY QUERY RELATIONS UNIT(X'7001')
```

The following output is displayed by the **FLASHCPY QUERY RELATIONS** command.

```
FLASHCOPY RELATIONS INFORMATION TABLE
ADDRESSSED VOLUME CU SERIAL NUMBER: 0000064552
```

ADDRESSSED VOLUME INFORMATION														PARTNER VOLUME INFO									
FLASHCPY SEQUENCE NUMBER	R/T	R	FV	BCE	BCP	CRA	VR	SWI	TWP	P	SEVI	PM	SOURCE	TARGET	EXTENT	# CONTIG TRKS IN	# TRACKS YET TO BE COPIED	SSID	LSS	CCA	SSID	LSS	CCA
00000000	SRC	F	F	F	F	F	F	F	F	F	F	FTTF	N	00010000	00120000	255	255	12C0	00	00	12C0	00	01
00000000	SRC	F	F	F	F	F	F	F	F	F	FTTF	N	00230000	00340000	255	255	12C0	00	00	12C0	00	01	

LEGEND

R/T = FLASHCOPY RELATIONSHIP TYPE OF ADDRESSSED VOLUME (SRC = SOURCE, TGT = TARGET)

R = REVERTIBLE (TRUE | FALSE)

FV = FULL VOLUME RELATION (TRUE | FALSE)

BCE = BACKGROUND COPY ENABLED (TRUE | FALSE)

BCP = BACKGROUND COPY IN PROGRESS (TRUE | FALSE)

CRA = CHANGE RECORDING ACTIVE (TRUE | FALSE)

VR = VALIDATION REQUIRED (T|F), REPORTED INFORMATION NOT CURRENT AND MAY NOT BE ACCURATE

SWI = SOURCE EXTENT WRITE INHIBITED (TRUE | FALSE | TFR = WRITE INHIBITED DUE TO FULL REPOSITORY)

TWP = TARGET EXTENT WRITE PROTECTED (TRUE | FALSE)

P = EXTENTS IN PERSISTENT RELATION (TRUE | FALSE)

SEVI = SPACE EFFICIENT VOLUME INFORMATION LEGEND:

S = VOLUME QUERIED IS SPACE EFFICIENT (TRUE | FALSE)

E = TARGET VOLUME IS SPACE EFFICIENT (TRUE | FALSE) WILL BE FALSE IF VOLUME QUERIED IS A TARGET

V = FLASHCOPY RELATION WILL BE FAILED IF TARGET IS OUT OF SPACE (TRUE | FALSE)

I = FLASHCOPY RELATION IS IN A FAILED STATE (TRUE | FALSE)

PM = PRESERVE MIRROR RELATIONSHIP INFORMATION LEGEND:

N = NOT A MIRRORED RELATIONSHIP

P = MIRRORED RELATIONSHIP, PREFERRED SPECIFIED

R = MIRRORED RELATIONSHIP, REQUIRED SPECIFIED

S = REMOTE MIRRORED RELATIONSHIP AT PPRC SECONDARY

U = MIRRORED RELATIONSHIP UNDETERMINED

N/A = NOT AVAILABLE

[Displaying information about Compatible FlashCopy V2 relationships: FLASHCPY QUERY RELATIONS on page 107](#) shows the information that is displayed by the **FLASHCPY QUERY RELATIONS** command.

## Releasing HCFNSE relationships

To release HCFNSE relationships, use any of the following host interfaces:

- PPRC TSO
- ICKDSF
- ANTRQST macro
- z/VM CP

## Using PPRC TSO FCWITHDR to release HCFNSE relationships

The **FCWITHDR** command can be used with HCFNSE. However, **DDSW=YES** cannot be specified. The allocated area remains even if the relationship is released, because withdrawal of the allocated area of the TSE-VOL cannot be specified.

The following example shows a request to release all relationships established with copy target extents in device 4203.

```
FCWITHDR TDEVN(X'4203')
```

## Using ICKDSF FLASHCPY WITHDRAW to release HCFCSE relationships

You can use the **FLASHCPY WITHDRAW** command to release HCFCSE relationships. However, you cannot specify the **MODE(COPY)** parameter. Specify the **RELATSPACE** parameter to release the allocated area of the TSE-VOL.

The valid parameter combinations cannot be changed. If you specify an invalid parameter combination, the **FLASHCPY WITHDRAW** command will end normally and perform no action.

The following table describes the parameters and the acceptable combinations of the **FLASHCPY WITHDRAW** command. See the following table and specify any other necessary parameters.

**Table 49 FLASHCPY WITHDRAW parameter combinations**

Parameter				Background copying
DDNAME, SYSNAME, UNITADDRESS	TARGETVOL	MODE	Executed	Relationship after completion
S-VOL	T-VOL	NOCOPY or not specified	No	Released
T-VOL	S-VOL or another volume	ALL	No	Released

The relationship whose copy source exists in the volume specified by DDNAME, SYSNAME, or UNITADDRESS will be released.

### Procedure

1. If you are using MVS® or z/OS®, specify the appropriate JCL DD statement to be used with the DDNAME parameter, or specify the S-VOL device number of the relationship that you want to delete in the UNITADDRESS parameter.  
If you are using VSE or z/VSE®, specify SYSNAME of the ASSGN system control statement in the SYSNAME parameter.
2. Specify the CU number, LDEV number, and device number of the T VOL in the TARGETVOL parameter.
3. Execute the **FLASHCPY WITHDRAW** command in NOCOPY mode.  
FLASHCPY WITHDRAW UNIT(X'7000') TARGETVOL(X'00',X'01',7001)  
MODE(NOCOPY)

When the **FLASHCOPY WITHDRAW** command is executed, all of the dataset relationships existing in the specified volume are withdrawn.

## Using ANTRQST macro FCWITHDRAW to release HCFCSE relationships

You can use the **FCWITHDRAW** command to release HCFCSE relationships. However, you cannot specify DDSW=YES. To release the allocated area of a TSE-VOL, specify SPACEREL=YES.

## Using z/VM CP FLASHCOPY WITHDRAW to release HCFCSE relationships

You can use the **FLASHCOPY WITHDRAW** command to release HCFCSE relationships. Specify the RELEASE parameter to release the allocated area of a TSE-VOL.

## Viewing TSE-VOL or pool information using the IDCAMS LISTDATA command

Use the IDCAMS **LISTDATA** command to display information about a TSE-VOL or a pool in the storage system. The only pool information displayed is for Dynamic Provisioning for Mainframe.

The following table shows the **LISTDATA** command parameters for viewing information about a TSE-VOL or pool. For more information about this command, see the *IBM® z/OS® DFSMS Access Method Services Commands*.

**Table 50 LISTDATA command parameters**

Parameter 1	Parameter 2	Description
SPACEEFFICIENTVOL	DEVICE	Displays information about the space-efficient device specified by the command (for example, the TSE-VOL).
	SUBSYSTEM	Displays information about all space-efficient devices in the storage system specified by the command.
	ALL	Displays information about all space-efficient devices in all connected storage systems. ALL is selected by default when the range is not specified.
EXTENTPOOLCONFIG	SUMMARY	Displays summary information for all pools.
	EXTENTPOOL ID (ID)	Displays detailed information about the specified pool.
MAPVOLUME	-	Displays all TSE-VOLs associated with pools, as bitmaps.

The following example shows the **LISTDATA** command for volume FCF6B6. For descriptions of the **VOLUME** and **UNIT** parameters, see the *IBM® z/OS® DFSMS Access Method Services Commands*.

```
LISTDATA SPACEEFFICIENTVOL VOLUME (FCF6B6) UNIT (3390)
```

TSE-VOL output from the **LISTDATA** displays as:

```

                2107 STORAGE CONTROL
                SPACE EFFICIENT VOLUME REPORT
STORAGE FACILITY IMAGE ID 002107.900.HTC.75.000000064561
                SUBSYSTEM ID X'150D'
                .....STATUS.....
                REPOSITORY
DEVICE  VOLSER  SPACE CONSUMED  SIZE  EXT POOL ID  REPOSITORY  SIZE
F6B6   FCF6B6           2      1113  007F           5197
TOTAL NUMBER OF SPACE EFFICIENT VOLUME(S) : 1

```

**Table 51 LISTDATA TSE-VOL information**

Item	Description
DEVICE	The device number recognized by the host.
VOLSER	The serial number of a volume.
REPOSITORY SPACE CONSUMED	The number of cylinders allocated to this TSE-VOL, not including control cylinders. Control cylinders are part of the internal storage system structure of the volume emulation. Control cylinders are included in the information displayed by HDvM - SN. In most cases, the HDvM - SN value for space used will be larger than the consumed space shown by LISTDATA.
SIZE	The configured capacity (number of cylinders) of the TSE-VOL.
EXT POOL ID	A pool ID.
REPOSITORY SIZE	The capacity of the pool (number of cylinders) to which this TSE-VOL is physically provisioned.
TOTAL NUMBER OF SPACE EFFICIENT VOLUME(S)	The number of TSE-VOLs in the storage system.

The following example displays the summary information for all pools.

```
LISTDATA EXTENTPOOLCONFIG VOLUME (FCF6B6) UNIT (3390) SUMMARY
```

```

                2107 STORAGE CONTROL
                EXTENT POOL CONFIGURATION REPORT
STORAGE FACILITY IMAGE ID 002107.900.HTC.75.000000064561
                .....EXTENT POOL ID 0002 SUMMARY.....
REPOSITORY FULL WARNING PERCENTAGE:           30
EXT POOL FULL WARNING PERCENTAGE:           30
EXTENT POOL STATUS
FIXED BLOCK EXT POOL:                          NO
REPOSITORY CONFIGURED:                         YES

```

```

EXTENT POOL AT WARNING PERCENTAGE: NO
EXTENT POOL FULL: NO

```

**Table 52 LISTDATA pool summary information**

Item	Description	
REPOSITORY FULL WARNING PERCENTAGE	-	The value after subtracting the user-defined warning threshold in the pool window in Device Manager - Storage Navigator from 100 (displays 30 when the threshold is 70).
EXT POOL FULL WARNING PERCENTAGE	-	The value after subtracting the user-defined warning threshold in the pool window in Device Manager - Storage Navigator from 100 (displays 30 when the threshold is 70).
FIXED BLOCK EXT POOL	NO (fixed)	The fixed block pool is not displayed. NO is displayed.
REPOSITORY CONFIGURED	YES (fixed)	If the pool exists, YES is displayed.
EXTENT POOL AT WARNING PERCENTAGE	YES	The value has reached the user-defined warning threshold in the pool window in Device Manager - Storage Navigator.
	NO	The value has not reached the user-defined warning threshold in the pool window in Device Manager - Storage Navigator. If the pool usage becomes 100% (full) after reaching the warning threshold, NO will be displayed.
EXTENT POOL FULL	YES	The pool usage amount is 100%.
	NO	The pool usage amount is not full.

The following command displays information for the specified pool ID.

```

LISTDATA EXTENTPOOLCONFIG VOLUME (FCF6B6) UNIT (3390)
EXTENTPOOLID (0)

```

```

                2107 STORAGE CONTROL
                EXTENT POOL CONFIGURATION REPORT
                STORAGE FACILITY IMAGE ID 002107.900.HTC.75.000000064561
                .....EXTENT POOL ID 0000 SUMMARY.....
REPOSITORY FULL WARNING PERCENTAGE:           30
EXT POOL FULL WARNING PERCENTAGE:           30
EXTENT POOL STATUS
    FIXED BLOCK EXT POOL:                      NO
    REPOSITORY CONFIGURED:                     YES
    EXTENT POOL AT WARNING PERCENTAGE:         NO
    EXTENT POOL FULL:                          YES
        ...EXTENT POOL 0000 DETAILED REPORT...
EXTENT POOL REPOSITORY STATUS
    REPOSITORY AT WARNING PERCENTAGE:          NO
    REPOSITORY FULL:                          YES
                SIZE                ALLOCATED
EXTENT POOL                8915                8915
REPOSITORY                  8915                8915

```

**Table 53 LISTDATA pool capacity information**

Item	Description	
REPOSITORY FULL WARNING PERCENTAGE	-	The value after subtracting the user-defined warning threshold in the pool window in Device Manager - Storage Navigator from 100 (displays 30 when the threshold is 70).
EXT POOL FULL WARNING PERCENTAGE	-	The value after subtracting the user-defined warning threshold in the pool window in Device Manager - Storage Navigator from 100 (displays 30 when the setting value is 70).
FIXED BLOCK EXT POOL	NO (fixed)	The fixed block pool is not displayed. NO is displayed.
REPOSITORY CONFIGURED	YES (fixed)	If the pool exists, YES is displayed.
EXTENT POOL AT WARNING PERCENTAGE	YES	The value has reached the user-defined warning threshold in the pool window in Device Manager - Storage Navigator.
	NO	The value has not reached the user-defined warning threshold in the pool window in Device Manager - Storage Navigator. If the pool usage becomes 100% (full) after reaching the warning threshold, NO will be displayed.
EXTENT POOL FULL	YES	The pool usage amount is 100% (full).
	NO	The pool usage amount is not full.
REPOSITORY AT WARNING PERCENTAGE	YES	The value has reached the user-defined warning threshold in the pool window in Device Manager - Storage Navigator.
	NO	The value has not reached the user-defined warning threshold in the pool window in Device Manager - Storage Navigator. Or, the pool usage becomes full after reaching the user-defined warning threshold in the pool window in Device Manager - Storage Navigator.
REPOSITORY FULL	YES	The pool usage amount is 100% (full).
	NO	The pool usage amount is not full.
EXTENT POOL SIZE	-	The capacity of the pool (in cylinders).
EXTENT POOL ALLOCATED	-	The number of cylinders allocated to the pool. The pool is allocated in pages. This value is created by converting the number of allocated pages into the number of cylinders.
REPOSITORY SIZE	-	The capacity of the pool (in cylinders).  This is the same value as the EXTENT POOL SIZE.
REPOSITORY ALLOCATED	-	The number of cylinders allocated to the pool.  This is the same value as the EXTENT POOL ALLOCATED.



# Hitachi Compatible FlashCopy® and IBM® FlashCopy® feature comparison

This chapter provides a feature comparison between IBM® FlashCopy® and Hitachi Compatible FlashCopy®. It covers the maximum number of relationships supported, the differences in the copy operations, the differences in how relationships are released, and compares the host interface command operations.

- [GLOBAL Mirror status](#)
- [Maximum number of relationships supported](#)
- [Copying operations](#)
- [Withdrawing relationships](#)
- [Comparing IBM HCFCSE and Hitachi Compatible FlashCopy SE](#)
- [Supporting commands](#)

## GLOBAL Mirror status

GLOBAL Mirror status is not supported in Compatible FlashCopy®, but is supported in IBM® FlashCopy®.

## Maximum number of relationships supported

The following table shows the maximum number of relationships between Hitachi Compatible FlashCopy® and IBM® FlashCopy®.

**Table 54 Maximum number of relationships between IBM FlashCopy and Hitachi Compatible FlashCopy**

Feature	IBM® FlashCopy®	Hitachi Compatible FlashCopy®
Number of multiple relationships	Up to 12 relationships can be created per extent. A track is the smallest unit.	Up to 16 relationships can be created per extent. A track is the smallest unit.
Maximum number of relationships that can be created per volume	50,099 relationships (for 3390-3) 65,534 relationships (other than 3390-3)	65,534 relationships (volume of 10,017 cylinders or more) 20,479 relationships (volume of less than 10,017 cylinders)

## Copying operations

The following table compares the copying operations of IBM® FlashCopy® and Hitachi Compatible FlashCopy®.

**Table 55 Comparison of copying operations**

Feature	IBM® FlashCopy®	Hitachi Compatible FlashCopy®
Read access to the area not specified as the copy range in the copy target during the background copying process in NOCOPY mode	The data on the tracks subject to read operation are not copied from the copy source to the copy target.	Sometimes the data on the tracks subject to read operation are copied from the copy source to the copy target, and other times the data are not copied to the target.
Status of the relationships when on-demand copy is processed	Relationships are withdrawn automatically when all of the copy operations processed by on-demand copy are completed.	Relationships are maintained even when all of the copy operations processed by on-demand copy are completed.
Creating TCz pairs in COPY mode or resynchronizing TCz pairs when a Compatible FlashCopy® relationship is established with the FREEZE option, and the source volume in the ELB state is specified as the S-VOL.	PPRC pair operation completes instantly, and the pair status changes to Pending. However, until the ELB state set for the PPRC S-VOL is released, initial copy will not start. Initial copy starts when the ELB state is released, and the pair status changes to Duplex when initial copy completes. Note that if	TCz pair operation is rejected.

Feature	IBM® FlashCopy®	Hitachi Compatible FlashCopy®
	the ELB state is not released in 45 seconds, the PPRC pair will be suspended.	
Establishing a new Compatible FlashCopy® relationship by using a source volume in the ELB state when a Compatible FlashCopy® relationship is established with the FREEZE option	A Compatible FlashCopy® relationship is established without waiting for the release of the ELB state set for the source volume.	A Compatible FlashCopy® relationship is established when the ELB state set for the source volume is released.
Reverse Restore	After all of the copy operations processed by on-demand copy are completed, the Reverse Restore operation can be performed on the relationship created by the Incremental FlashCopy® function with NOCOPY specified or on the relationship after Restore or Reverse Restore is performed.	After all of the copy operations processed by on-demand copy are completed, the Reverse Restore operation cannot be performed on the relationship created by the Incremental FlashCopy® function with NOCOPY specified or on the relationship after Restore or Reverse Restore is performed.
Fast Reverse Restore	Regardless of whether or not the option of the Incremental FlashCopy® function is specified, if you perform the Fast Reverse Restore, the part of the data which is copied from the S-VOL to the T-VOL will be copied from the T-VOL to the S-VOL.	When you perform the Fast Reverse Restore specifying the option of the Incremental FlashCopy® function, only the data that has been changed on the S-VOL or the T-VOL will be copied from the T-VOL to the S-VOL.  When you perform the Fast Reverse Restore function without specifying the Incremental FlashCopy® function, only the copied data from the S-VOL to the T-VOL will be copied before the Fast Reverse Restore is executed.
Establishing relationships with NOCOPY specified without an option of the Incremental FlashCopy® function, then performing Fast Reverse Restore with NOCOPY specified without an option of the Incremental FlashCopy® function and I/Os.	The relationship is released.	The relationship is maintained with the source volume and the target volume reversed.
Copying in NOCOPY mode in FlashCopy® to PPRC Primary Volume function	When a FlashCopy® relationship in NOCOPY mode is created using a PPRC P-VOL, the data is not copied from FlashCopy® S-VOL to FlashCopy® T-VOL, and the FlashCopy® S-VOL data is copied to the PPRC S-VOL. When the FlashCopy® relationship is deleted, the PPRC P-VOL data is copied to the PPRC S-VOL data.	When a Compatible FlashCopy® V2 relationship in NOCOPY mode is created using a TCz P-VOL, the copy operation is executed to the Compatible FlashCopy® relationship T-VOL and TCz pair S-VOL. The copy operation is not executed even if the Compatible FlashCopy® relationship is deleted.  The value of BCE or BCP displays as F(FALSE) though the value of "#TRACKS YET TO BE COPIED" displayed by the ICKDSF FLASHCOPY QUERY RELATIONS command changes, depending on the number of tracks in which the copy has not been completed.

Feature	IBM® FlashCopy®	Hitachi Compatible FlashCopy®
Copying in NOCOPY mode in the FlashCopy® to URz Primary Volume function	-	When Compatible FlashCopy® relationship in NOCOPY mode is created using URz P-VOL, the copy operation is executed to the Compatible FlashCopy® relationship T-VOL and URz pair S-VOL. The copy operation is not executed even if the Compatible FlashCopy® relationship is deleted.  The value of BCE or BCP displays as F(FALSE) though the value of "#TRACKS YET TO BE COPIED" displayed by the ICKDSF <b>FLASHCOPY QUERY RELATIONS</b> command changes, depending on the number of tracks on which the copy has not been completed.
Receiving Failover/Failback command to TCz pairs in FlashCopy® to PPRC Primary Volume function	Receives <b>Failover</b> /Failback command.	<b>Failover</b> command is received, but after that, the Compatible FlashCopy® relationship T-VOL will be used as the TCz pair S-VOL. Therefore, the <b>Failback</b> command is rejected.
Executing ReverseResync command on URz pairs in the FlashCopy® to URz Primary Volume function	-	The <b>ReverseResync</b> command is rejected because the Compatible FlashCopy® relationship T-VOL will be used as URz pair S-VOL.
Execute ICKDSF command for Compatible FlashCopy® to TCz P-VOL in Pending status	Ends Normally.	Ends abnormally with CC=12.
Establishing a TCz pair in NOCOPY mode whose P-VOL is a Compatible FlashCopy® relationship T-VOL that you establish in NOCOPY mode	Neither FlashCopy® data nor PPRC data can be copied.	Data can be copied from the Compatible FlashCopy® relationship S-VOL to T-VOL but not to the TCz S-VOL. In this state, if you release the Compatible FlashCopy® relationship, the data of TCz P-VOL and S-VOL will be different.
Establishing a URz pair in NOCOPY mode whose P-VOL is a Compatible FlashCopy® V2 relationship T-VOL that you establish in NOCOPY mode	-	Data can be copied from the Compatible FlashCopy® relationship S-VOL to the T-VOL but not to the URz S-VOL. In this state, if you release the Compatible FlashCopy® relationship, the data of URz P-VOL and the S-VOL will be different.
The operation used when a TCz pair with the Remote FlashCopy® function is in the Pending status.	The relationship can be established.	The relationship cannot be established.
The operation used when relationship-creation fails in the secondary site for Preserve Mirror FlashCopy®	The relationship on the secondary site is not created, though the local relationship may be created. In this case, the TCz volume associated with the Compatible FlashCopy® V2 relationship T-VOL is in suspend status.	Neither local or remote relationships are created.

## Withdrawing relationships

The following table compares how relationships are withdrawn for Hitachi Compatible FlashCopy® and IBM® FlashCopy®.

**Table 56 Differences in how relationships are withdrawn**

Feature	IBM® FlashCopy®	Hitachi Compatible FlashCopy®
Withdraw command with a specified extent area. See the following figure.	The command deletes the relationships within the specified extent area.  When the specified extent area is included only in a part of the central existing relationship area, only the existing relationships of the area will be divided.	When a part of the existing relationship area is included in the extent area specified by the withdraw command, the existing relationship is not released, except in some exceptional cases. If you specify DDSW(YES) or if the range specified with SDEVN contains at least part of the relationship source, the relationship is released after a background copy is executed.
REMOVEFCPY (ICKDSF CONTROL command)	The command will finish normally. Relationships will not be deleted.	Not supported. The command will finish abnormally. Relationships will not be deleted.
Establishing a dataset relationship using DFSMSdss, and specifying the source or target volume of a volume relationship as the copy target	Part of the volume relationship is withdrawn.	<ul style="list-style-type: none"> <li>When you specify the source volume of a volume relationship as the copy target, the entire volume relationship will be withdrawn.</li> <li>When you specify the target volume of a volume relationship as the copy target, the volume relationship will be withdrawn.</li> </ul>

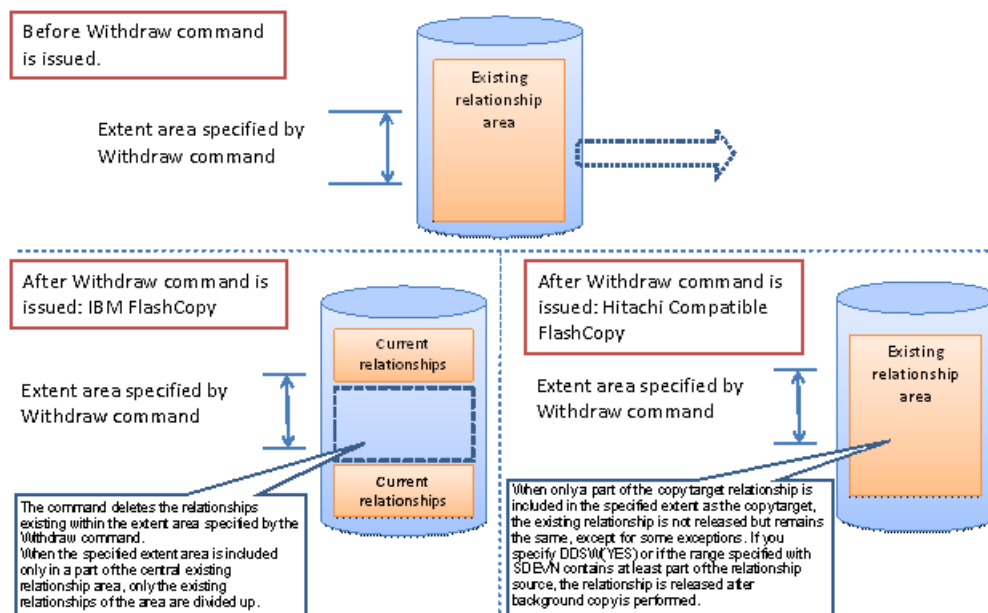

**Note:** Creating a relationship can fail if any of the following events occur:

- A scratch operation
- Deletion of datasets
- Volume initialization

To avoid this problem, use the **FCWITHDR** command to withdraw the relationship, or wait until the background copy operation is completed and the relationship is withdrawn. For information about scratch operations, see the *IBM® Device Support Facilities (ICKDSF) User's Guide and Reference*.

## Comparing IBM® HCFSE and Hitachi Compatible FlashCopy® SE

The following table compares IBM® HCFSE and Hitachi Compatible FlashCopy® SE.

**Table 57 Comparing IBM HCFSE and Hitachi Compatible FlashCopy SE**

Feature	IBM® HCFSE	Compatible FlashCopy® SE
Action when the pool is full	Since usage amount in the pool is managed in units of tracks, you cannot write to the pool when the pool is full.	The usage amount in the pool is managed in units of pages, and the usage amount of the TSE-VOL is managed in units of tracks in a page. When pages cannot be allocated because the pool is full, you can write to the pool until all tracks in the page are used.
Changing volume status to online	After you change the T-VOL status of a FlashCopy® relationship to online and then change it to offline and execute Fast Reverse Restore, you can change the new S-VOL status to online.	After you change the T-VOL status of a Compatible FlashCopy® SE relationship to online and then change it to offline and execute Fast Reverse Restore, you cannot change the new S-VOL status to online because the data might be inconsistent.

## Supporting commands

This section describes restrictions to host commands you use to manage Compatible FlashCopy® V2 operations.

### TSO command restrictions

Compatible FlashCopy® V2 does not support the following TSO command parameters:

**FC Establish** command:

- OPENDVCS
- MODE (ASYNCR)

**FC Query** command:

- OPENDVCS

- UNFORMAT

**FC Withdraw** command:

- OPENDVCS
- ACTION (COMMIT/REVERT)

## ICKDSF command restrictions

Compatible FlashCopy® V2 does not support the following parameters of the following ICKDSF command:

**FLASHCPY WITHDRAW** command:

- REVERT | COMMIT

IBM® FlashCopy® supports the ICKDSF commands, while Compatible FlashCopy® V2 supports a subset of the ICKDSF commands. If a TCz P-VOL or SIz S-VOL is in Pending status, and you execute ICKDSF commands on the volume, the commands will end abnormally and generate a CC=12 error. See [ICKDSF command terminates abnormally on page 162](#).

## ANTRQST command restrictions

Compatible FlashCopy® V2 does not support the following ANTRQST macro commands:

**REQUEST=FCESTABL** command:

- OPENDVCS
- MODE (ASYNC)

**REQUEST=FCQUERY** command:

- OPENDVCS

**REQUEST=FCWITHDRAW** command:

- OPENDVCS
- ACTION (COMMIT/REVERT)

## z/VM CP command restrictions

Compatible FlashCopy® V2 does not support any of the **QUERY FLASHCOPY** commands.



# Troubleshooting

This chapter provides troubleshooting information for Compatible FlashCopy® and instructions for calling technical support.

- [Compatible FlashCopy relationship is suspended](#)
- [ICKDSF command terminates abnormally](#)
- [SIM reporting](#)
- [Contacting customer support](#)

## Compatible FlashCopy® relationship is suspended

Compatible FlashCopy® relationships might be suspended when a hardware or software failure occurs. If Compatible FlashCopy® relationships are suspended, hosts might be unable to access T-VOL datasets.

To determine if a suspended Compatible FlashCopy® relationship exists for a volume, use the Pair Operation window. If the Relationships column of the volume list displays S-Failed or T-Failed, a suspended Compatible FlashCopy® relationship exists for the volume.

To delete a suspended Compatible FlashCopy® relationship, do one of the following:

- Delete the target dataset that is inaccessible from the host. The operating system is automatically notified that the relationship has been deleted. It then executes a command to withdraw the relationship.
- If you can identify the suspended Compatible FlashCopy® relationship, execute the TSO **FCWITHDR** command to its extent.

## ICKDSF command terminates abnormally

When you execute an ICKDSF command to a TCz P-VOL or SIz to a P-VOL in Pending status, the ICKDSF job will end abnormally and generate a CC=12 error.

The following table explains how to avoid abnormal termination of ICKDSF commands.

**Table 58 Avoiding abnormal termination of ICKDSF commands**

Command	How to avoid abnormal termination
FLASHCPY ESTABLISH	<ul style="list-style-type: none"> <li>• Use the TSO command or the DFSMSdss command.</li> <li>• Check if a TCz pair or SIz pair is in Duplex or Suspend status, and then execute the <b>FLASHCPY ESTABLISH</b> command. To check the pair status, use the TSO <b>CQUERY</b> command.</li> </ul>
FLASHCPY WITHDRAW	<ul style="list-style-type: none"> <li>• Use the TSO command.</li> <li>• Check if a TCz pair or SIz pair is in Duplex or Suspend status, and then execute the <b>FLASHCPY WITHDRAW</b> command. To check the pair status, use the TSO <b>CQUERY</b> command.</li> </ul>
FLASHCPY QUERY FLASHCPY QUERY RELATIONS	<ul style="list-style-type: none"> <li>• Execute the <b>FLASHCPY QUERY</b> or the <b>FLASHCPY QUERY RELATIONS</b> command to the T-VOL of the Compatible FlashCopy® relationship.</li> <li>• When you are going to execute the <b>FLASHCPY QUERY</b> or the <b>FLASHCPY QUERY RELATIONS</b> command on the S-VOL of a Compatible FlashCopy® relationship, check if a TCz pair or SIz pair is in Duplex or Suspend status, and then execute the</li> </ul>

Command	How to avoid abnormal termination
	command. Use the <code>QUERY</code> command of the TSO to check the pair status

## SIM reporting

The storage system sends a service information message (SIM) to the host to notify the user of a possible service requirement for the storage system.

SIMs are classified according to severity for reporting and logging purposes.

- Service
- Moderate
- Serious
- Acute

The message number indicates the importance: the larger the number, the more important the message. The SVP reports all SIMs for Compatible FlashCopy® operations. The SIMs are stored on the SVP for use by Hitachi personnel. The SIMs reported to the mainframe host are logged in `SYS1.LOGREC`. Depending on the system settings, the amber Message LED on the storage system might be lit each time a SIM is generated. Hitachi Device Manager - Storage Navigator also displays SIMs.

The following figure shows a typical 32-byte storage system SIM.

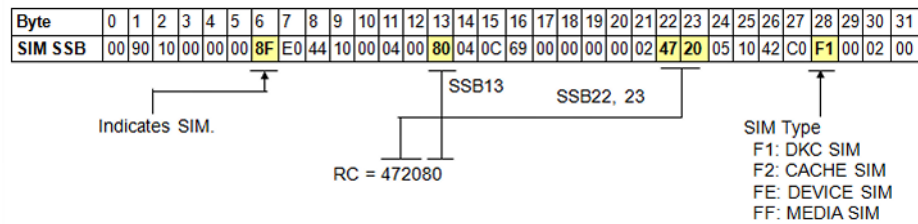

**Figure 36 Typical SIM showing the reference code and SIM type**

SIMs are displayed on the host console by reference code (RC) and severity. The six-digit RC (bytes 13, 22, and 23) identifies the error and determines the severity. The SIM type (byte 28) indicates the component that experienced the error.

The following table shows the SIM specific to SIZ operations.

**Table 59 SIZ SIM**

Reference code			SIM type (byte 28)	Importance level	Description
SSB22	SSB23	SSB13			
4b	2x	yy	FE	Moderate	Copying process of Compatible FlashCopy® terminates abnormally. Internally the

Reference code			SIM type (byte 28)	Importance level	Description
SSB22	SSB23	SSB13			
					<p>relationship becomes suspended by the failure, and the T-VOL becomes partially inaccessible.</p> <ul style="list-style-type: none"> <li>• x indicates the last digit of the T-VOL's CU number (00 to FE).</li> <li>• yy indicates the LDEV number of the T-VOL.</li> </ul> <p>In the case of a tier memory access error, SIM=4b4xyy is output rather than this SIM.</p> <p>Tier memory is an area for storing relationship information.</p> <p>For SIM=4b4xyy, see the following item in this table.</p>
4b	4x	yy	FE	Moderate	<p>Copying process of Compatible FlashCopy® ends abnormally because of a tier memory access error. Internally the relationship becomes suspended by failure, and the T-VOL becomes partially inaccessible.</p> <ul style="list-style-type: none"> <li>• x indicates the last digit of the CU number of the failed volume (00 to FE).</li> <li>• yy indicates the LDEV number of the failed volume.</li> </ul>
47	e5	00	F1	Moderate	<p>The Compatible FlashCopy® relationship is automatically withdrawn, and the T-VOL becomes inaccessible because the power supply was turned on while the shared memory volatilized.</p>
7f	f1	05	F1	Service	<p>If either SIM=4b2xyy or SIM=4b4xyy is output, further output of either type of SIM is inhibited for five minutes. For example, if SIM=4b4111 is output, SIM=4b4xyy is not output for five minutes, regardless of xyy. This SIM reports the occurrence of this delay.</p>

## Contacting customer support

If you need to contact customer support, make sure to provide as much of the following information as possible.

Information that you need to provide includes:

- The circumstances surrounding the error or failure.
- The exact content of any error messages displayed on the host systems.
- The exact content of any error messages displayed by Hitachi Device Manager - Storage Navigator.
- The Hitachi Device Manager - Storage Navigator configuration information (use the Dump Tool).
- The service information messages (SIMs), including reference codes and severity levels, displayed by Device Manager - Storage Navigator.

The Hitachi Data Systems customer support staff is available 24 hours a day, seven days a week. If you need technical support, log on to Hitachi Data Systems Support Connect for contact information: [https://support.hds.com/en\\_us/contact-us.html](https://support.hds.com/en_us/contact-us.html)



## Compatible FlashCopy® GUI reference

This appendix describes the Device Manager - Storage Navigator windows and tabs for Compatible FlashCopy®. Some of the Compatible FlashCopy® windows and tabs are also used for ShadowImage for Mainframe.

- [Replication window](#)
- [History window](#)
- [Edit Local Replica Option wizard](#)
- [Edit SCP Time wizard](#)

## Replication window

The Replication window displays the local and remote replication summary information and provides access to the Compatible FlashCopy® operations on Device Manager - Storage Navigator, such as viewing operation histories and setting the system options.

The screenshot shows the 'Replication' window with the following summary data:

Local Replication	Licensed Capacity (Used/Licensed)	Remote Replication	Licensed Capacity (Used/Licensed)
SI	200.00 GB / Unlimited	TC	100.00 GB / Unlimited
TI	400.00 GB / Unlimited	UR	100.00 GB / Unlimited
SIMF	200.00 GB / Unlimited	TCMF	100.00 GB / Unlimited
FCv2	200.00 GB / Unlimited	URMF	100.00 GB / Unlimited
FCSE	200.00 GB / Unlimited	GAD	100.00 GB / Unlimited
Number of Replica LDEVs		16	
Number of FCv2/FCSE Relationships		2	
Number of Differential Tables		824 (Max Allowed: 419200)	

The 'Replica LDEVs' table below shows 16 entries with columns: LDEV ID, LDEV Name, Emulation Type, Capacity, Copy Type, SI-L1, SI-L2, TI, SIMF, FCv2, FCSE, TC, UR, TCMF, URMF, GAD.

## Summary area

Item	Description
View History button - Local Replication	Opens the History window for local replication.
View History button - Remote Replication	Opens the History window for remote replication.
Edit Options button - Local Replication	Opens the Edit Local Replica Options window.
Edit Options button - Remote Replication	Opens the Edit Remote Replica Options window.
Edit Options button - SCP Time	Opens the Edit SCP Time window.
Licensed Capacity	The used capacity and the licensed capacity of each product.
Number of Replica LDEVs	Number of LDEVs used for replication pairs and relationships.

Item	Description
Number of FCv2/FCSE Relationships	Total number of relationships for Compatible FlashCopy® V2 and Compatible FlashCopy® SE.
Number of Differential Tables	<p>The number and the maximum number of differential tables that are already used in local replication.</p> <p>The number of differential tables that are already used in remote replication is not included.</p> <p>Differential tables will not be used for the following operations. Therefore, the number of differential tables will not increase or decrease by executing the following operations.</p> <ul style="list-style-type: none"> <li>• SI pair operations for a DP-VOL that exceeds 4 TB.</li> <li>• TI pair operations.</li> <li>• Siz pair operations for a DP-VOL that exceeds 262,668 cylinders.</li> <li>• Compatible FlashCopy® V2 or Compatible FlashCopy® SE relationship operations.</li> </ul>

### Replica LDEVs tab

This tab displays Compatible FlashCopy®/Compatible FlashCopy® SE source and target volume information.

Item	Description
LDEV ID	Identifier (ID) of the selected LDEV
LDEV Name	Name of the selected LDEV
Emulation Type	Emulation type of the selected LDEV
Capacity	Capacity of the selected LDEV
Copy Type	<p>Copy type:</p> <ul style="list-style-type: none"> <li>• FCv2: Compatible FlashCopy® relationship</li> <li>• FCSE: Compatible FlashCopy® SE relationship</li> <li>• GAD: global-active device pair</li> </ul> <p>Volume types (SI, TI, SIMF, TC, UR, TCMF, URMF, GAD):</p> <ul style="list-style-type: none"> <li>• Primary: Primary volume</li> <li>• Secondary: Secondary volume</li> </ul> <p>Volume types (FCv2 and FCSE):</p> <ul style="list-style-type: none"> <li>• S-Normal: Normal source volume</li> <li>• T-Normal: Normal target volume</li> <li>• ST-Normal: Normal volume set for both source and target volumes</li> <li>• S-Failed, S-Full, S-Full&amp;Failed: Abnormal source volume</li> <li>• T-Failed, T-Full, T-Full&amp;Failed: Abnormal target volume</li> <li>• ST-Failed, ST-Full, ST-Full&amp;Failed: Abnormal volume set for both source and target volumes</li> </ul>
Virtual Storage Machine*	<p>Displays information about the virtual storage machine to which the LDEV belongs:</p> <ul style="list-style-type: none"> <li>• Model type/Serial number: Displays the model type and serial number of the virtual storage machine.</li> <li>• LDEV ID: Displays the volume's virtual LDEV ID. A blank displays when no virtual LDEV ID is assigned.</li> </ul>

Item	Description
	<ul style="list-style-type: none"> <li>Device Name: Displays the virtual device name of the volume in a combined format, which includes virtual emulation type, number of virtual LUSE volumes, and virtual CVS attribute. A blank is displayed when none of virtual emulation type, number of virtual LUSE volumes or virtual CVS attribute are specified. Only the attributes that have been specified are displayed. If the virtual CVS attribute is specified, CVS is displayed at the end.</li> <li>SSID: Displays the virtual SSID of the volume. A blank displays when no virtual SSID is specified.</li> </ul>
Export	Opens the dialog for downloading table information to a file.
*These items are not shown in the table by default. To display these items, use the Column Settings window. For details, see the <i>Hitachi Virtual Storage Platform G1000 System Administrator Guide</i> .	

## History window

The History window displays the Compatible FlashCopy®/Compatible FlashCopy® SE primary and secondary volumes that have an operation history. Up to 16,384 operation histories are displayed per page. A maximum of 1,024,000 latest operations histories are stored in the storage system.

History window showing FCv2/FCSE History (Page.1). The table displays operation details including Date and Time, Source Volume (LDEV ID and Provisioning Type), Target Volume (LDEV ID and Provisioning Type), Relationship ID, and Description Code. The total number of operations is 16384.

Date and Time	Source Volume		Target Volume		Relationship ID	Description Code
	LDEV ID	Provisioning Type	LDEV ID	Provisioning Type		
2012/09/01 01:15:17	-	-	-	-	-	0029
2012/09/01 01:13:37	-	-	-	-	-	0019
2012/08/24 08:28:18	-	-	-	-	-	0029
2012/08/24 08:26:42	-	-	-	-	-	0019
2012/08/24 06:53:50	-	-	-	-	-	0029
2012/08/24 06:52:05	-	-	-	-	-	0019
2012/08/02 01:55:30	-	-	-	-	-	0029
2012/08/02 01:53:51	-	-	-	-	-	0019
2012/06/29 02:45:29	-	-	-	-	-	0019
2012/06/11 20:05:03	00:3E:3F	DP	-	-	-	0056
2012/06/11 20:05:02	00:3E:3E	DP	-	-	-	0056
2012/06/11 20:05:02	00:3E:3D	DP	-	-	-	0056
2012/06/11 20:05:01	00:3E:3C	DP	-	-	-	0056
2012/06/11 20:05:01	00:3E:3B	DP	-	-	-	0056
2012/06/11 20:05:00	00:3E:3A	DP	-	-	-	0056
2012/06/11 20:05:00	00:3E:39	DP	-	-	-	0056
2012/06/11 20:05:00	00:3E:38	DP	-	-	-	0056
2012/06/11 20:04:59	00:3E:37	DP	-	-	-	0056
2012/06/11 20:04:59	00:3E:36	DP	-	-	-	0056

## Setting fields

Item	Description
Copy Type	<ul style="list-style-type: none"><li>FCv2/FCSE: Compatible FlashCopy® V2 and Compatible FlashCopy® SE</li><li>SI: ShadowImage</li><li>TI: Thin Image</li><li>SI MF: ShadowImage for Mainframe</li></ul>

## History table

Item	Description
Date	Operation date and time
Source Volume	Displays the following source volume information: <ul style="list-style-type: none"><li>LDEV ID: LDEV identifier of the source volume</li><li>Provisioning Type, which can be one of the following:<ul style="list-style-type: none"><li>- Basic: Internal volume</li><li>- DP: DP-VOL</li><li>- External: External volume</li><li>- External MF: FICON® Data Migration volume</li></ul></li></ul>
Target Volume	Displays the following target volume information: <ul style="list-style-type: none"><li>LDEV ID: LDEV identifier of the target volume</li><li>Provisioning Type, which can be one of the following:<ul style="list-style-type: none"><li>- Basic: Internal volume</li><li>- DP: DP-VOL</li><li>- External: External volume</li></ul></li></ul>
Mirror Unit	Not applicable to Compatible FlashCopy®/Compatible FlashCopy® SE. Displayed only for Thin Image (TI).
Pool ID	Displayed only when TI is selected from the Copy type field.
Relationship ID	Displayed only when FCv2/FCSE are selected as values in the Copy Type field.  In VSP G1000 and G1500, and VSP F1500, the relationship ID is the number uniquely assigned to each LDEV ID for relationships in source volumes. In earlier model storage systems, the relationship ID is a number uniquely assigned within the storage system.
Description Code	The code number of the message.
Description	Displays the operation message. For details, see <a href="#">Viewing relationship operations history on page 112</a> .
Export	Opens the dialog for downloading table information to a file.

## Edit Local Replica Option wizard

The Edit Local Replica Option wizard includes the following windows:

- [Edit Local Replica Options window on page 172](#)
- [Edit Local Replica Options confirmation window on page 173](#)

## Edit Local Replica Options window

Use this window to change the Compatible FlashCopy® system options.

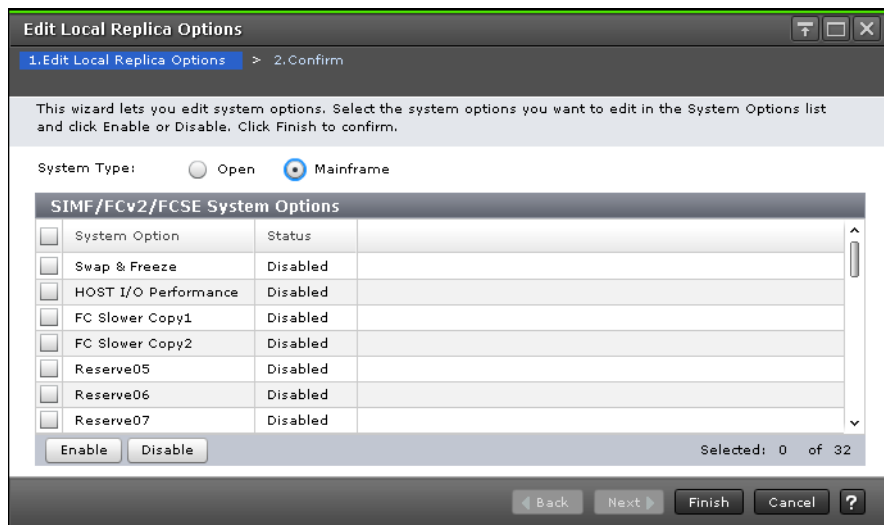

### SIMF/FCv2/FCSE System Options table

This table is displayed when the System Type is Mainframe.

Item	Description
System Option	<p>Displays the system options. The number next to each system option indicates the system option number.</p> <ul style="list-style-type: none"> <li>• Swap &amp; Freeze (1): Use this option when you want to save data immediately after Quick Restore as-is. When you enable this option and execute Quick Restore, update copying after Quick Restore is inhibited, the secondary volume in the DUPLEX status is saved without being updated.</li> <li>• Host I/O Performance (2): Use this option when you give higher priority on I/O response than volume copy time. Enabling this option inhibits execution of copy processing, thereby improving host I/O response.</li> <li>• FC Slower Copy1 (3): Reduces the number of relationships for which background copy processing can be performed concurrently for Compatible FlashCopy® relationships to one half when no option is specified, thereby improving host I/O response.</li> <li>• FC Slower Copy2 (4): Reduces the number of relationships for which background copy processing can be performed concurrently for Compatible FlashCopy® relationships to one quarter when no option is specified, thereby improving the host I/O response.</li> <li>• Nondisruptive Migration Data Consistency (16): Use this option to keep the latest data in the migration source storage system instead of distributing data in the destination and source storage systems during data migration.</li> <li>• FC Ext. Slower Copy1 (17): When the MP blade usage rate to which the source volume or target volume in a Compatible FlashCopy® relationship is allocated exceeds 65%, background copy operations of the Compatible</li> </ul>

Item	Description
	<p>FlashCopy® relationship are suppressed, and consequently host I/O response improves.</p> <ul style="list-style-type: none"> <li>• FC Ext. Slower Copy2 (18): When the MP blade usage rate to which the source volume or target volume in a Compatible FlashCopy® relationship is allocated exceeds 50%, background copy operations of the Compatible FlashCopy® relationship are suppressed, and consequently host I/O response improves.</li> <li>• Copy Pace Ext. Slower1 (20)</li> <li>• Copy Pace Ext. Slower2 (21)</li> <li>• Copy Pace Ext. None (22)</li> </ul> <p>Use these options to prevent impact on host server I/O performance by suppressing copy processing only if the pair status is DUPLEX. These options are enabled for all pairs that have DUPLEX status. The I/O performance of the host server is improved most effectively with Copy Pace Ext. None, followed by Copy Pace Ext. Slower2, and then Copy Pace Ext. Slower1.</p> <ul style="list-style-type: none"> <li>• Quick/Steady Split Multiplexing (ShadowImage/ShadowImage for Mainframe) (24) Accelerates the splitting of ShadowImage for Mainframe pairs. The multiplicity of copy processing (the number of relationships for which background copy processing can be performed concurrently) for each pair is changed from 1 to 24.</li> <li>• Reverse Copy Multiplexing (ShadowImage/ShadowImage for Mainframe) (25) Accelerates the resynchronization of ShadowImage for Mainframe pairs. The multiplicity of copy processing (the number of relationships for which background copy processing can be performed concurrently) for each pair is changed from 1 to 24.</li> </ul>
Status	<p>Enabled or Disabled:</p> <ul style="list-style-type: none"> <li>• Enabled: If you select a system option you want to enable, the Status column displays Enabled.</li> <li>• Disabled: If you select a system option you want to disable, the Status column displays Disabled.</li> </ul>

## Edit Local Replica Options confirmation window

Use this window to confirm your changes to the Compatible FlashCopy® system options.

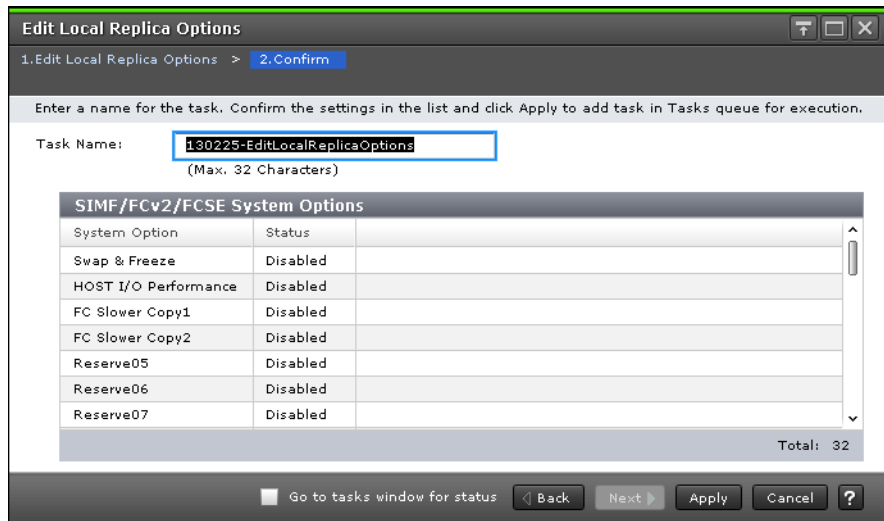

### SIMF/FCv2/FCSE System Options table

Item	Description
System Option	Displays the system options.
Status	Indicates whether the system option is enabled or disabled.

## Edit SCP Time wizard

The Edit SCP Time wizard includes the following windows:

- [Edit SCP Time window on page 174](#)
- [Change SCP Time dialog on page 175](#)
- [Edit SCP Time confirmation window on page 176](#)

## Edit SCP Time window

Use this window to change the SCP time.

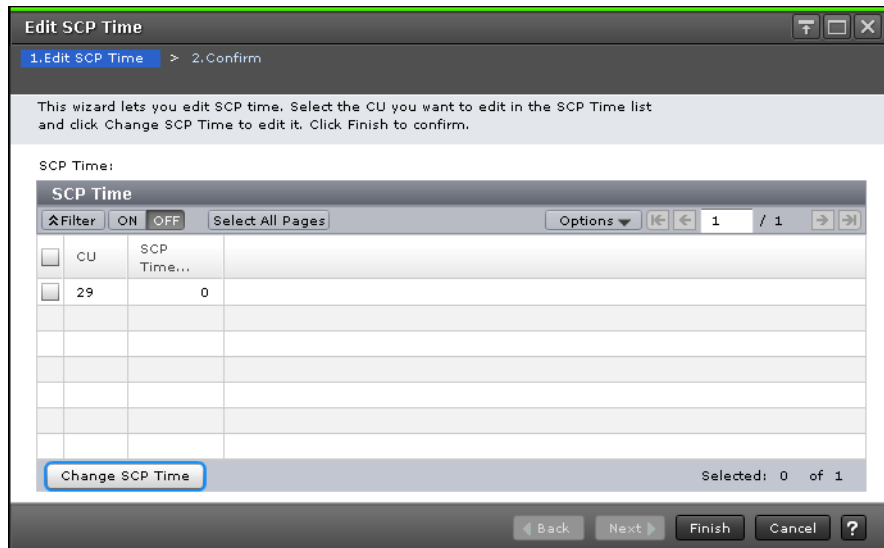

## SCP Time table

Item	Description
CU	CU number
SCP Time (sec.)	SCP time set for each CU. The range is 0-518,400 seconds (6 days).
Change SCP Time	Opens the Change SCP Time dialog.

## Change SCP Time dialog

Use this window to enter the desired SCP time.

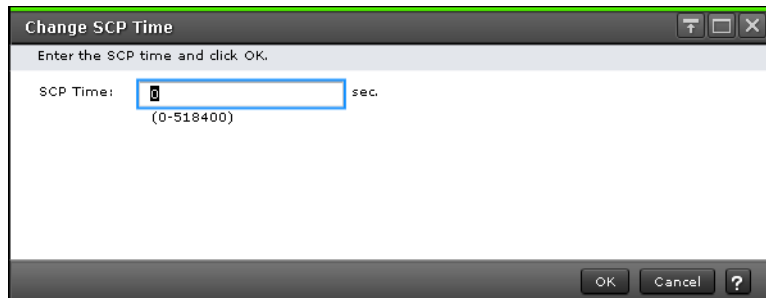





# Index

- A**
  - ANTRQST 87
- B**
  - background copying 21
- C**
  - consistency group 27
  - COPY mode 21
- D**
  - dataset copying 26
- E**
  - extent 19
- F**
  - Fast Reverse Restore 31
  - Fast Reverse Restore Function 31
  - FlashCopy 28, 30, 37
  - FLASHCPY ESTABLISH (Fast Reverse Restore) 86
  - FLASHCPY ESTABLISH (Restore) 86
  - FLASHCPY ESTABLISH (Reverse Restore) 85
  - FLASHCPY QUERY 106
  - FLASHCPY QUERY RELATIONS 107, 145
  - FLASHCPY WITHDRAW 130
  - Function 28
- I**
  - Incremental 28, 30
  - interoperability 47
- M**
  - MIH 50
- N**
  - NOCOPY mode 21
- O**
  - on-demand copying 22
- P**
  - pairs
    - history 112
- R**
  - relationship 19
  - Remote 37
  - Reverse Restore 30
  - Reverse Restore function 30
- S**
  - service information message 163
  - SIM 163
  - support 164
- V**
  - volume copying 26





## **Hitachi Data Systems**

### **Corporate Headquarters**

2845 Lafayette Street  
Santa Clara, California 95050-2639  
U.S.A.

[www.hds.com](http://www.hds.com)

### **Regional Contact Information**

#### **Americas**

+1 408 970 1000

[info@hds.com](mailto:info@hds.com)

#### **Europe, Middle East, and Africa**

+44 (0) 1753 618000

[info.emea@hds.com](mailto:info.emea@hds.com)

#### **Asia Pacific**

+852 3189 7900

[hds.marketing.apac@hds.com](mailto:hds.marketing.apac@hds.com)

#### **Contact Us**

[www.hds.com/en-us/contact.html](http://www.hds.com/en-us/contact.html)



**MK-92RD8010-10**

**March 2017**